



**Oregon  
Department  
of Transportation**

## **Sign Policy & Guidelines**

**Delivery & Operations Division | Traffic Roadway Section  
January 2023**

ODOT is an Equal Employment Opportunity and Affirmative Action Employer.

This information can be made available in alternative format by contacting the traffic section at 503-986-3568.

ODOT does not discriminate on the basis of disability in admission or access to our programs, services, activities, hiring and employment practices. Questions: 1-877-336-6368 (EEO-ODOT) or through Oregon Relay Service at 7-1-1.

**Oregon Department of Transportation**  
Engineering & Technical Services Branch  
Traffic-Roadway Section  
4040 Fairview Industrial Dr. SE, MS5  
Salem, Oregon 97302  
503-986-3568

<https://www.oregon.gov/odot/Engineering/Pages/Traffic.aspx>

**Table of Contents**

**Chapter 1: Introduction ..... 14**  
Sign Types ..... 15  
Sign Restrictions..... 16

**Chapter 2: Signs and Policy by MUTCD Section ..... 19**  
Retro-reflectivity and Illumination (MUTCD 2A.07)..... 19  
Symbols (MUTCD 2A.12) ..... 19  
Sign Borders (MUTCD 2A.14)..... 19  
Overhead Sign Installations & Mounting Height (MUTCD 2A.17 & 2A.18)..... 19  
Lateral Offset (MUTCD 2A.19)..... 20  
Posts and Mounting (MUTCD 2A.21)..... 20  
Fire Danger Signs..... 21

**Chapter 3: Regulatory Signs..... 22**  
Right of Way at Intersections (MUTCD 2B.04) on Low Volume Cross Streets..... 22  
EXCEPT RIGHT TURN Sign (R1-10P) (MUTCD 2B.05)..... 23  
Speed Limit Sign (R2-1) (MUTCD 2B.13)..... 23  
Passing, Keep Right, and Slow Traffic Signs (MUTCD 2B.28, 2B.29, & 2B.30) ..... 23  
Slow Vehicle Turn-out Signs (R4-12, R4-13, & R4-14) (MUTCD 2B.35)..... 24  
DO NOT ENTER Sign (R5-1) (MUTCD 2B.37) ..... 24  
Selective Exclusion Signs (MUTCD 2B.39)..... 24  
One Way Signs (R6-1 & R6-2) (MUTCD 2B.40) ..... 25  
Emergency Restriction Signs (R8-4, R8-7, & R8-8) (MUTCD 2B.49)..... 25  
Traffic Signal Signs (R10-5 through R10-30) (MUTCD 2B.53) ..... 25  
No Turn on Red Signs (R10-11 Series, R10-17a, & R10-30) (MUTCD 2B.54)..... 25  
Oregon Regulatory Sign Details..... 26

**Chapter 4: Warning Signs..... 97**  
Design of Warning Signs (MUTCD 2C.03)..... 97  
Placement of Warning Signs (MUTCD 2C.05)..... 97

Horizontal Alignment Warning Signs (MUTCD 2C.06) ..... 97

Horizontal Alignment Signs (W1-1 through W1-5, W1-11, W1-15) (MUTCD 2C.07)..... 97

Advisory Speed Plaque (W13-1P) (MUTCD 2C.08)..... 97

Speed Hump Sign (W17-1) (MUTCD 2C.29)..... 98

Lane Ends Signs (W4-2, W9-1, W9-2) (MUTCD 2C.42)..... 98

Intersection Warning Signs (W2-1 through W2-8) (MUTCD 2C.46)..... 98

Intersection Warning Signs- Roundabouts (W2-6 and W16-12P) (MUTCD 2C.46)..... 99

Non-vehicular Warning Signs (W11-2, W11-3, W11-4, W11-6, W11-7, W11-9, and W11-16 through W11-22) (MUTCD 2C.50)..... 99

Use of Supplemental Warning Plaques (MUTCD 2C.53)..... 100

Policy for the use of Sign Flag Boards (Yellow or Orange Diamonds)..... 100

Oregon Warning Sign Details ..... 102

**Chapter 5: Guide Signs ..... 135**

Chapter 5A-Conventional Roads ..... 135

Chapter 5B-Freeways and Expressways..... 145

Oregon Guide Sign Details ..... 157

**Chapter 6: Construction and Maintenance Signs ..... 201**

Application of Standards..... 201

Flagger Signs (MUTCD 6F.31)..... 201

Uneven Lanes Sign (W8-11) (MUTCD 6F.45)..... 201

Reverse Curve Signs (W1-4 Series) (MUTCD 6F.48)..... 201

Detour Signs (M4-8, 9 & 10) (MUTCD 6F.49)..... 201

Work Duration (MUTCD 6G.02)..... 201

General (MUTCD 6I.01)..... 202

Roll-Up Signs..... 202

Business Access Signs in Construction Projects ..... 202

Oregon Construction Sign Details..... 204

**Chapter 7: School Area Signs ..... 253**

Sign Color for School Warning Signs (MUTCD 7B.07)..... 253

School Zone Sign and Plaques and End School Zone Sign (S1-1, S4-3P, S4-7P, & S5-2) (MUTCD 7B.09)..... 253

Higher Fines Zone Signs (MUTCD 7B.10)..... 254

School Advance Crossing Assembly (MUTCD 7B.11)..... 254

School Crossing Assembly (MUTCD 7B.12) ..... 254

School Speed Limit Assembly (S4-1, S4-2, S4-3, S4-4, S4-6, & S5-1) and End School Speed Limit Sign (S5-3) (MUTCD 7B.15)..... 255

Reduced Speed School Zone Ahead Sign (S4-5 & S4-5a) (MUTCD 7B.16)..... 255

General Information..... 255

School Zone Conditions..... 256

School Zone Signing Layouts..... 257

Oregon School Area Sign Details ..... 267

**Chapter 8: Bicycle Signs..... 272**

Bicycle Warning and combined Bicycle/Pedestrian Signs (W11-1 & W11-15) (MUTCD 9B.18). 272

Other Bicycle Warning Signs (MUTCD 9B.19)..... 272

Bicycle Racing..... 272

Bicycle Routes..... 272

Oregon Bicycle Sign Details..... 273

**Appendix A: US Forest Service and ODOT Signing Agreement..... 286**

**Appendix B: Oregon Sign Detail Index..... 292**

**List of Figures**

Figure 1: Example of a Post-mounted Fire Danger Sign .....21

Figure 2: Sign OR2-6a (END SPEED ZONE) Detail.....26

Figure 3: Sign OR3-5L & OR3-5R (left (right) turn ONLY) Detail.....27

Figure 4: Sign OR3-5TD (left and right arrow) Detail.....28

Figure 5: Sign OR3-5TT (through, left, and right arrow) Detail.....29

Figure 6: Sign OR3-7a (EXCEPT BUS) Detail .....30

Figure 7: Sign OR3-10a & OR3-10b (Snow Lane Control) Detail.....31

Figure 8: Sign OR3-11b (LEFT LANE BUS ONLY) Detail.....32

Figure 9: Sign OR3-11c (LEFT LANE BUS & LEFT TURN ONLY) Detail.....33

Figure 10: Sign OR3-12 (U-TURN PERMITTED) Detail.....34

Figure 11: Sign OR4-5 (TRUCKS RIGHT TWO LANES ONLY) Detail.....35

Figure 12: Sign OR4-11 & OR4-11A (YIELD CENTER LANE TO UPHILL TRAFFIC) Detail .....36

Figure 13: Sign OR4-16 (TRUCKS-CAMPERS-TRAILERS-BUSES UNLAWFUL TO USE LEFT LANE EXCEPT WHEN PASSING) and Sign OR4-17 (TRUCKS-CAMPERS-TRAILERS-BUSES UNLAWFUL TO USE LEFT LANES EXCEPT WHEN PASSING) Detail.....37

Figure 14: Sign OR4-18 (STATE LAW TRUCKS-CAMPERS-TRAILERS-BUSES UNLAWFUL TO USE LEFT LANE EXCEPT WHEN PASSING ON 4 LANE HIGHWAYS) and Sign OR4-19 (STATE LAW TRUCKS-CAMPERS-TRAILERS-BUSES UNLAWFUL TO USE LEFT LANES EXCEPT WHEN PASSING ON 6 LANE HIGHWAYS) Detail.....39

Figure 15: Sign OR4-20a (STATE LAW MOVE OVER OR SLOW DOWN) Detail .....41

Figure 16: OR4-22 (DO NOT DRIVE BESIDE TRUCKS) Detail.....42

Figure 17: Sign OR5-3A (NON-MOTORIZED VEHICLES USE NEXT EXIT) Detail .....43

Figure 18: Sign OR5-11 (ONE WAY TRAFFIC FOR TRUCKS AND BUSES) Detail.....44

Figure 19: Sign OR7-1 (NO OVERNIGHT PARKING-PARKING PROHIBITED BETWEEN 1:00 AM AND 5:00 AM) Detail .....45

Figure 20: Sign OR7-8c (WHEELCHAIR USER ONLY) Details .....46

Figure 21: Sign OR7-9 (No Parking in Access Aisle) Detail.....47

Figure 22: Sign OR7-9a Detail .....48

Figure 23: Sign OR7-20 (NO PARKING VEHICLES OVER X FT. HIGH) Detail.....49

Figure 24: Sign OR8-4A (NO PARKING FOR UNATTENDED VEHICLES) Detail .....50

Figure 25: Sign OR10-3L & OR10-3R Detail.....51

Figure 26: OR10-4bL & OR10-4bR Detail.....52

Figure 27: Sign OR10-15 (TURNING VEHICLES stop FOR peds) Detail.....53

Figure 28: Sign OR10-15A (TURNING VEHICLES stop FOR bikes & peds) Detail.....54

Figure 29: OR10-15b (TURNING VEHICLES yield TO bikes) Detail.....55

Figure 30: Sign OR10-25L & OR10-25R Detail.....56

Figure 31: Sign OR10-32L & OR10-32R (PUSH BUTTON FOR Peds HOLD FOR 2 SECONDS FOR EXTRA CROSSING TIME) Detail.....57

Figure 32: Sign OR11-4a (ROAD CLOSED TO THRU TRAFFIC LOCAL ACCESS ONLY) Detail .....58

Figure 33: Sign OR12-5 (WEIGHT LIMIT REDUCED) Detail .....59

Figure 34: Sign OR12-5d (WEIGHT LIMITS (Class A)) Detail.....60

Figure 35: Sign OR12-5e (WEIGHT LIMIT CLASS A X MILES AHEAD) Detail.....61

Figure 36: OR12-5f (WEIGHT LIMIT REDUCED FOR LEGAL LOADS) Detail.....62

Figure 37: Sign OR12-5g (WEIGHT LIMIT REDUCED FOR SINGLE UNIT VEHICLES ONLY) Detail.....63

Figure 38: Sign OR12-5h (WEIGHT LIMIT REDUCED FOR EMERGENCY VEHICLES ONLY) Detail.....64

Figure 39: Sign OR12-5i (WEIGHT LIMIT REDUCED EMERGENCY VEHICLES rider) Detail .65

Figure 40: Sign OR12-6 (XX TON BRIDGE WEIGHT LIMIT XX MILES AHEAD) Detail.....66

Figure 41: OR12-8 (LENGTH LIMIT) Detail .....67

Figure 42: Sign OR14-6 (Motor Carrier Pilot Car Stop) Detail.....68

Figure 43: Signs OR15-15A, OR15-15B, OR15-15C, OR15-15D (Snow Zone Riders) Detail.....69

Figure 44: Signs OR15-15A, OR15-15B, OR15-15C, OR15-15D (Snow Zone Riders) Detail.....70

Figure 45: Sign OR16-6 (UNLAWFUL TO THROW AWAY BURNING MATERIAL) Detail.....72

Figure 46: Sign OR17-1 (LEFT TURN YIELD TO ONCOMING TRAFFIC) Detail.....73

Figure 47: Sign OR18-1 (ENTERING WINTER RECREATION AREA PARKING PERMITS REQUIRED BEYOND THIS POINT NOV. 1 TO APRIL 30) Detail .....74

Figure 48: Sign OR18-2 (NO PARKING FOR UNATTENDED VEHICLES NOV. 1 TO APRIL 30) Detail.....75

Figure 49: Sign OR18-3 (SNO-PARK PARKING PERMITS REQUIRED NOV. 1 TO APRIL 30) Detail.....76

Figure 50: Sign OR18-4 (SNO-PARK PARKING PERMITS REQUIRED “Nov. 1 TO April 30”) Detail.....	77
Figure 51: Sign OR20-1 (ONE VEHICLE PER GREEN) Detail.....	78
Figure 52: Sign OR20-5 (FORM 2 LANES WHEN METERED) Detail.....	79
Figure 53: Sign OR21-1 (NO FISHING FROM BRIDGE) Detail.....	80
Figure 54: Sign OR21-2a (DIVING OR JUMPING FROM BRIDGE PROHIBITED) Detail.....	81
Figure 55: Sign OR21-3a (DON'T LITTER MAX FINE \$6250) Detail.....	82
Figure 56: Sign OR21-4a (MOBILE DEVICE USE PROHIBITED WHILE DRIVING) Detail.....	83
Figure 57: Sign OR22-1 (MOTORCYCLISTS STATE LAW REQUIRES USE OF LIGHTS AT ALL TIMES) Detail.....	84
Figure 58: Sign OR22-2 (HELMETS REQUIRED) Detail.....	85
Figure 59: Sign OR22-3 (SAFETY BELTS IT'S THE LAW) Detail.....	86
Figure 60: Sign OR22-4 (ALL TRUCKS, OVER 20,000 GVW RIGHT) Detail.....	87
Figure 61: Sign OR22-6 (YIELD TO ONCOMING TRAFFIC) Detail.....	88
Figure 62: Sign OR22-7 (CROSSWALK CLOSED) Detail.....	89
Figure 63: Sign OR22-9 (DO NOT PASS SNOWPLOWS ON THE RIGHT) Detail.....	90
Figure 64: Sign OR22-10 (STATE LAW-UNMUFFLED ENGINE BRAKING PROHIBITED) Detail.....	91
Figure 65: Sign OR22-11 (UNMUFFLED ENGINE BRAKING PROHIBITED) Detail.....	92
Figure 66: Sign OR22-16 & OR22-17 (NO LANE CHANGES NEXT XXXX FT) Detail.....	93
Figure 67: Sign OR22-18 (RAMP CLOSED) Detail.....	94
Figure 68: Sign OR22-19 (ODOT PERSONNEL ONLY MAX LOADING XXX LBS) Detail.....	95
Figure 69: Sign OR22-20 (NO ATVs symbol sign) Detail.....	96
Figure 70: Sign OW7-4 (SLOW TRUCKS) Detail.....	102
Figure 71: Sign OW7-5 (TRUCK WEIGHING AHEAD) Detail.....	103
Figure 72: Sign OW11-1a (ON ROADWAY) Detail.....	104
Figure 73: Sign OW11-1b (ON SHOULDER) Detail.....	105
Figure 74: Sign OW11-7 (OPEN RANGE) Detail.....	106
Figure 75: Sign OW12-2P (Low Clearance) Detail.....	107
Figure 76: Sign OW14-3 (PRIVATE DRIVE) Detail.....	108
Figure 77: Sign OW15-1 (SLOW) Detail.....	109



Figure 78: Sign OW15-6 (CONGESTION) Detail.....	110
Figure 79: Sign OW15-11 (TUNNEL) Detail.....	111
Figure 80: Sign OW15-12 (HIGH WATER) Detail.....	112
Figure 81: Sign OW15-12 (PREPARE TO STOP WHEN LIGHTS FLASH) Detail.....	113
Figure 82: Sign OW15-15 (SNOW ZONE) Detail.....	114
Figure 83: Sign OW15-16 (OVERSIZE LOAD) Detail.....	116
Figure 84: Sign OW15-17 (LONG LOAD) Detail.....	117
Figure 85: Sign OW15-17a (LONG LOAD) Detail.....	118
Figure 86: Sign OW15-18 (WIDE LOAD) Detail.....	120
Figure 87: Sign OW15-19 (SLIDES) Detail.....	121
Figure 88: Sign OW16-10 (BYPASS PHOTO ENFORCED) Detail.....	122
Figure 89: Sign OW21-1 (STOP AHEAD) Detail.....	123
Figure 90: Sign OW21-4 (BRAKE CHECK AREA) Detail.....	124
Figure 91: Sign OW21-5 & OW21-6 (BRAKE CHECK AREA) Detail.....	125
Figure 92: Sign OW22-1a (CHAIN-UP AREA) Detail.....	126
Figure 93: Sign OW22-2 & OW22-3 (CHAIN-UP AREA) Detail.....	128
Figure 94: Sign OW22-4a (CHAIN REMOVAL AREA) Detail.....	129
Figure 95: Sign OW22-5 & OW22-6 (CHAIN REMOVAL AREA) Detail.....	130
Figure 96: Sign OW22-7 (Highway Advisory Radio) Detail.....	132
Figure 97: Sign OW22-15 (NO LANE CHANGES AHEAD) Detail.....	133
Figure 98: Sign OW22-16 (ATV Warning Symbol Sign) Detail.....	134
Figure 99: Sign OD9-10a (Welcome Center) Detail.....	157
Figure 100: Typical Freeway Signing when Welcome Center or Information Center is not located in rest area.....	158
Figure 101: Typical Freeway sign for Travel Info. Center in rest area.....	158
Figure 102: Typical Freeway sign for Welcome Center when located in rest area.....	159
Figure 103: Sign OD11-1 (ENTERING WINTER RECREATION AREA PARKING PERMITS REQUIRED IN SNO-PARKS NOV 1 TO APRIL 30) Detail.....	160
Figure 104: Sign OD11-2 (SNO-PARK AHEAD 1/4 MILE) Detail.....	161
Figure 105: Sign OD12-1 (PULL OUT) Detail.....	162

Figure 106: Sign OD12-2 (PULL OUT X MILE) Detail..... 163

Figure 107: Sign OD-411A (ENTERING XX City) Detail..... 164

Figure 108: Sign OD-412 (ENTERING XX County) Detail..... 165

Figure 109: Sign OD-413 (WELCOME TO XX City) Detail..... 166

Figure 110: Sign OD-413A Detail..... 167

Figure 111: Sign OD-414 (WELCOME TO XX County) Detail..... 168

Figure 112: Sign OD417 (ADOPT-A HIGHWAY PROGRAM) Detail..... 169

Figure 113: Sign OD418 (ADOPT-A LANDSCAPE PROGRAM) Detail..... 170

Figure 114: Sign D-424 (HISTORICAL MARKER AHEAD) Detail..... 171

Figure 115: Sign D-424A (GEOLOGICAL MARKER AHEAD) Detail..... 172

Figure 116: Sign D-434 (State Parks Shield) Detail..... 173

Figure 117: Sign D-435 Detail..... 174

Figure 118: Sign ORG-010 (Heritage Site) Detail..... 175

Figure 119: Sign D447 (SAFETY CORRIDOR NEXT XX MILES) Detail..... 176

Figure 120: Sign OD-449 (END SAFETY CORRIDOR) Detail..... 177

Figure 121: Sign OD450 (Hydrant Marker) Detail..... 178

Figure 122: Sign OD460 (WELCOME TO OREGON) Detail..... 179

Figure 123: Sign D461 (OREGON THANKS YOU COME BACK SOON) Detail..... 180

Figure 124: Sign OD-462 (TSUNAMI HAZARD ZONE) Detail..... 181

Figure 125: Sign OD-464 (EVACUATION SITE) Detail..... 182

Figure 126: Sign OD-465 (ENTERING TSUNAMI HAZARD ZONE) Detail..... 183

Figure 127: Sign OD-466 (LEAVING TSUNAMI HAZARD ZONE) Detail..... 184

Figure 128: Sign OI5-1 (LEWIS AND CLARK TRAIL) Detail..... 185

Figure 129: Sign OI6-1 (CALIFORNIA TRAIL) Detail..... 186

Figure 130: Sign OI7-1 (OREGON TRAIL) Detail..... 187

Figure 131: Sign OI7-3 (TRAIL SITE) Detail..... 188

Figure 132: Sign OI7-4 (RIVER ROUTE) Detail..... 189

Figure 133: Sign OI7-4A (TRAIL ROUTE) Detail..... 190

Figure 134: Sign OI7-6 (BARLOW ROAD ROUTE) Detail..... 191

Figure 135: Sign OI7-8 & OI7-9 (Applegate Trail) Detail..... 192

Figure 136: Sign OI7-10 & OI7-11 (Applegate Trail) Detail.....	193
Figure 137: Sign D-480 (Entrance Sign) Detail.....	194
Figure 138: Sign D-481 (Exit Sign) Detail.....	195
Figure 139: Sign D-482 (Trailblazer) Detail .....	196
Figure 140: Sign D-483 (Trailblazer with directional arrow) Detail.....	197
Figure 141: Sign D-484 (Oregon Tour Route) Detail.....	198
Figure 142: Sign D-485 (OREGON HISTORIC ROUTE) Detail .....	199
Figure 143: Sign D-486 (KEEP OREGON GREEN) Detail.....	200
Figure 144: Sign CG20-1 (ROAD WORK NEXT XX MILES) Detail .....	204
Figure 145: Sign CG20-2A (END ROAD WORK) Detail.....	205
Figure 146: Sign CG20-5 (END DETOUR) Detail .....	206
Figure 147: Sign CG20-6 (DETOUR) Detail.....	207
Figure 148: Sign CG20-8 (Project Identification) Detail.....	208
Figure 149: Sign CG20-10 (EROSION CONCERNS) Detail.....	209
Figure 150: Sign CG20-11 (BUSINESS ACCESS) Detail .....	210
Figure 151: Sign CG20-13 (INTERMITTENT ROAD WORD NEXT XX MILES) Detail .....	211
Figure 152: Sign CG20-20, CG20-20L, CG20-20R, CG20-20T, CG20-20LA, & CG20-20RA (Pedestrian Event Route) Detail.....	212
Figure 153: Signs CG20-21, CG20-21L, CG20-21R, CG20-21T, CG20-21LA, & CG20-21RA (Bicycle Event Route) Detail .....	214
Figure 154: Sign CR1-1 (STOP) Detail.....	216
Figure 155: Sign CR4-20 (WAIT FOR PILOT CAR) Detail .....	217
Figure 156: Sign CR4-20a (WAIT FOR PILOT CAR) Detail.....	219
Figure 157: Sign CR4-22a & CR4-22b (KEEP LEFT (RIGHT)) Detail.....	220
Figure 158: Sign CR4-23 (WAIT FOR FLAGGER) Detail .....	221
Figure 159: Sign CR4-24 (WAIT FOR ASSISTANCE) Detail .....	222
Figure 160: Sign CW11-1 (Bicycles ON ROADWAY) Detail .....	223
Figure 161: Sign CW11-1a (Bicycles CROSSING ROADWAY) Detail.....	224
Figure 162: Sign CW11-2 (Pedestrians ON ROADWAY) Detail.....	225
Figure 163: Sign CW11-2a (Pedestrians CROSSING ROADWAY) Detail.....	226

Figure 164: Sign CW11-3 (SIDEWALK OPEN) Detail.....	227
Figure 165: Sign CW11-4 (SIDEWALK CLOSED) Detail.....	228
Figure 166: Sign CW11-5 (SIDEWALK CLOSED) Detail.....	229
Figure 167: Sign CW15-10 (WRECK AHEAD) Detail.....	230
Figure 168: Sign CW15-15 (EVENT AHEAD) Detail.....	231
Figure 169: Sign CW15-15a (Bicycle EVENT AHEAD) Detail.....	232
Figure 170: Sign CW15-15b (Pedestrian EVENT AHEAD) Detail.....	233
Figure 171: Sign CW17-1 (BICYCLE RACE IN PROGRESS) Detail.....	234
Figure 172: Sign CW17-2 (BICYCLE RIDE IN PROGRESS) Detail.....	235
Figure 173: Signs CW20-1a & CW8-7a (ROAD WORK (LOOSE GRAVEL) XX MPH) Detail...	236
Figure 174: Sign CW20-5a (LEFT TWO LANES CLOSED AHEAD) Detail.....	238
Figure 175: Sign CW20-5b (Flagger NEXT MILE) Detail.....	239
Figure 176: Sign CW20-9 (24-HOUR FLAGGING AHEAD) Detail.....	240
Figure 177: Sign CW21-7 (ABRUPT EDGE) Detail.....	241
Figure 178: CW21-8A, CW21-8B & CW21-8C (Abrupt Edge Riders) Detail.....	242
Figure 179: Sign CW21-9 (ABRUPT EDGE) Detail.....	243
Figure 180: Sign CW21-10 & CW21-11 (BRIDGE WORK AHEAD) Detail.....	244
Figure 181: Sign CW21-11 (Horizontal Clearance) Detail.....	245
Figure 182: Sign CW23-2 (Flagger Ahead) Detail.....	246
Figure 183: CW23-6 (PASSING LANE CLOSED AHEAD) Detail.....	247
Figure 184: Sign CW23-7 (TRUCKS ENTERING HIGHWAY XXXX FT.) Detail.....	248
Figure 185: Sign CW23-8 (TRUCKS LEAVING HIGHWAY XXXX FT.) Detail.....	249
Figure 186: Sign CW23-12 (LEFT TURN LANE CLOSED AHEAD) Detail.....	250
Figure 187: Sign CW23-13 (LEFT TURN LANE CLOSED) Detail.....	251
Figure 188: CW23-14 (CONSTRUCTION VEHICLE DO NOT FOLLOW) Detail.....	252
Figure 189: Overhead Pedestrian Crossing Sign (R1-9a).....	254
Figure 190: School Zone Condition A (Adjacent to School Grounds).....	256
Figure 191: School Zone Condition B (Crosswalk/Non-adjacent to School Grounds).....	256
Figure 192: Overhead School Crossing Sign (Optional).....	257
Figure 193: Ground-Mounted Overhead School Crossing Sign (Optional).....	257

Figure 194: Condition "A" Layout without School Crosswalk.....	258
Figure 195: Condition "A" Layout with School Crosswalk.....	260
Figure 196: Condition "B" School Crosswalk Not Adjacent To School Grounds .....	262
Figure 197: School Crosswalk Away From School at Signalized Intersection (Optional).....	264
Figure 198: School Building Away From Highway or School Grounds Fenced (Optional) .....	265
Figure 199: School Crosswalk Away From School (Optional).....	266
Figure 200: Sign OS3-2 (SCHOOL BUS TURN AROUND) Detail.....	267
Figure 201: Sign OS4-8 (SCHOOL DAYS with Time of Day) Detail.....	268
Figure 202: Sign OS4-9 (SCHOOL IN SESSION) Detail.....	269
Figure 203: Sign OS5-5 (SCHOOL SPEED LIMIT 20) Detail.....	270
Figure 204: Sign OBR1-1 (Bicycle (Symbol) STOP symbol) Detail.....	273
Figure 205: OBR1-2 (Bicycle (Symbol) YIELD) Detail.....	274
Figure 206: Sign OBR10-13 (SIDEWALK USERS WALK BIKES) Detail.....	275
Figure 207: Sign OBW1-8 (BIKES IN TUNNEL WHEN LIGHTS FLASH) Detail.....	276
Figure 208: Sign OBW1-9 (Bike Lane Ends Symbol) Detail.....	277
Figure 209: Sign OBW8-19L & OBW8-19R (Bike Railroad Crossing Symbol) Detail.....	278
Figure 210: Sign OBW8-22 (Bike-Ped Warning) Detail .....	279
Figure 211: Sign OBW15-1 (SLOW (Bikes)) Detail.....	280
Figure 212: Sign OBD1-1c, OBD1-2c, & OBD1-3c Detail.....	281
Figure 213: Sign OBD11-3 (OREGON COAST BIKE ROUTE) Detail.....	282
Figure 214: Sign OBD11-3a (XXXX TRAIL) Detail.....	283
Figure 215: Signs OBM1-8 & OBM1-8a (SCENIC BIKEWAY Route) Detail.....	284
Figure 216: Examples of signs where ODOT is responsible for installation and maintenance..	289
Figure 217: Examples of signs where USFS is responsible for installation and maintenance....	290
Figure 218: Examples of signs where USFS/ODOT share financial performance responsibility for installation and maintenance.....	291



## **Chapter 1: Introduction**

The Oregon Department of Transportation is responsible for furnishing and maintaining directional, regulatory, warning, and informational signing on the state highway system.

ODOT's sign policy is a combination of Oregon revised statutes, administrative rules, Federal Highway Administration rules and guidelines, and engineering judgment. The Oregon Transportation Commission has adopted the Federal Manual on Uniform Traffic Control Devices (MUTCD) with Oregon Supplements as the signing manual for the state of Oregon (See OAR 734-020-0005). Since the MUTCD is adopted as policy, this document deals exclusively with items not included in the MUTCD or items that need further clarification as they are used on the state highway system.

It is important to remember that if a policy exists and the sign meets the necessary criteria, the sign will be erected only when there is adequate space along the highway, and only if the designated location generates a large enough traffic volume to justify the placement of the sign. Funds and availability of our maintenance forces may also factor in. Existing signs not in conformance with this policy should be brought into compliance on a replacement basis.

### Sign Types

1. Regulatory
  - Colors: Black, red, or green letters on white background.
  - Types: Black letters - requires person to follow regulation on sign.  
Red letters - prohibits action listed on sign.  
Red circle and slash (symbol signs) prohibits action depicted on sign.  
Green circle (symbol signs) allows action depicted on sign.  
Green letters - Allows action listed on sign.
  - Exceptions: STOP and YIELD signs, disabled person's parking sign.
2. Warning
  - Colors: Black letters or symbol on yellow background.
  - Type: Warns driver of existing or anticipated condition.
  - Exceptions: STOP, YIELD, and SIGNAL AHEAD signs.
3. Construction
  - Colors: Black letters or symbol on orange background.
  - Type: Gives direction or warning in construction or maintenance areas.
  - Exception: Regulatory and warning signs may also be posted in construction zones (i.e., STOP signs).
4. Destination Guide Signs
  - Colors: White letters or symbol on green background.
  - Type: Identifies city, town, or destination.
5. Recreational Guide Signs
  - Colors: White letters or symbol on brown background.
  - Type: Identifies recreational opportunities or destination.
6. Motorist Service Signs
  - Colors: White letters on blue background.
  - Type: Can be either word message or a symbol identifying services such as, but not limited to food, gas, lodging, camping, police, viewpoint, phone, hospital, diesel, tourist, and rest areas.



7. Logo Signs\*  
Colors: White letters on blue background with business logo.  
Type: Gas, food, lodging, camping.
8. Tourist Oriented Directional Signs (TODS\*)  
Colors: White letters on blue background.  
Type: Business identification and direction information for tourist-oriented businesses and services. Identifies cultural and historical features. Used only on the primary and secondary systems, not the interstate.
9. Historical and Cultural Signs  
Colors: White letters on brown background, if single destination.  
White letters on green background, if used with other destinations.  
White letters on blue background, if off interstate. \*  
Type: Identifies historical or cultural features available on the interstate system. \*\*

\* Refer requests for signing to: Sue VanHandel, Oregon Travel Information Council, 1500 Liberty Street SE, Salem, Oregon 97302 (503) 373-0086.

\*\* Refer requests for signing to: Trudy Colombi, ODOT Traffic-Roadway Section, 4040 Fairview Industrial Dr., Salem, Oregon 97302 (503) 986-3604.

## Sign Restrictions

The following signs are not allowed on the state highway system. The state traffic engineer may allow certain exceptions.

- Advertising.
- Amusement parks.
- Animal shelter.
- Billboards.
- Cemeteries.
- Chamber of commerce.
- Churches.
- Commercial businesses ([see traffic generator signing, Chapter 5](#)).
- Day care centers.
- Death markers.

- Drive-in theaters.
- Drug-free school zone.
- Educational service district.
- Field burning.
- Fraternity or sorority.
- Golf courses.
- Green River Ordinance.
- Kindergartens.
- Medical clinics.
- Memorial highways (See Blue Star Rest Area Signing).
- Miniature golf.
- Neighborhoods.
- Neighborhood watch.
- Nuclear-free zone.
- Nursing homes.
- Political signs.
- Public open market.
- Public agency ([See Chapter 5](#)).
- Private agencies.
- Recycling centers (private).
- Residential complexes.
- Retirement homes.
- Rodeos.
- Service clubs.
- Skating rinks.
- Special interest districts (See T.O.D. Signing).
- Sports clubs.
- Stockyards.
- Trade Schools.
- Urgent care facilities.

- Veterans' affairs offices.
- Waste transfer stations.
- Water shed districts.

## Chapter 2: Signs and Policy by MUTCD Section

### Retro-reflectivity and Illumination (MUTCD 2A.07)

Road name, route shield, and mileage signs mounted on overhead roadway structures should not be illuminated.

### Symbols (MUTCD 2A.12)

Standard symbol signs should be used in lieu of word message signs, except as listed below.

Exceptions:

The symbol alternatives for the following signs shall not be used on the state highway system. The word message legend shall be used on these signs.

- NARROW BRIDGE (W5-2).
- PAVEMENT ENDS (W8-3).

### Sign Borders (MUTCD 2A.14)

Table 1: Sign borders for regulatory and warning signs

Board Dimensions	Border	Margin	Corner Radius
Either or both less than 30 inches	5/8"	3/8"	1 1/2"
Both 30 inches	3/4"	1/2"	1 7/8"
Both more than 30 inches and either less than 48 inches	7/8"	5/8"	2 1/4"
Both 48 inches or larger	1 1/4"	3/4"	3"

For sign borders on guide signs, see MUTCD Section 2E.16.

### Overhead Sign Installations & Mounting Height (MUTCD 2A.17 & 2A.18)

Overhead sign structures on state highways should provide a vertical clearance between 18 and 19 feet over the entire width of pavement and shoulders. For more information see the ODOT Traffic Structures Design Manual. Any time a new overhead traffic structure is added or an additional one is modified that alters the vertical clearance on state highways contact the region mobility liaison. The region mobility liaison will provide the appropriate coordination with the region and the Commerce and Compliance Division

The distance from the ground line to the bottom of a single sign should be a minimum of 7 feet. If more than one sign is mounted on a single post, the bottom of the sign assembly should be a minimum of 6 feet above ground line. This vertical distance is required for signs to clear an impacting vehicle upon collision. Signs may be mounted higher to obtain vertical height requirements for pavement clearance.

The 7-foot minimum height requirement may be waived for parking-related signs where little or no interference with pedestrians exists.

## Lateral Offset (MUTCD 2A.19)

When practical and not restricted by right of way, the following minimum lateral clearances should be maintained to the nearest edge of the sign (except as noted \*).

Table 2: Minimum Lateral Clearances

Sign Type	Face of Guardrail	Edge of Paved Shoulder
Major Guide Signs on Freeways & Expressways	6 feet	30 feet *
Control / Route Signs on Freeways & Expressways	6 feet	12 feet
Major Guide Signs on Conventional Roads	6 feet	20 feet *
Control / Route Signs on Conventional Roads	6 feet	12 feet
Stop Signs on Conventional Roads	6 feet	6 feet

\*From fog line to the center of the nearest support.

## Posts and Mounting (MUTCD 2A.21)

Ground mounted signs not protected by guardrail or barrier should be installed on breakaway posts. Any sign support that could be struck by a vehicle should be of the breakaway type. Nominal 4" x 4" wood posts are considered to be breakaway. If larger wood posts are used, they shall have holes drilled through the post at 4" and 18" above the ground line at right angles to the movement of traffic. Two wood posts may be used as a breakaway support if the distance between the posts is at least 7 feet. Design guidelines for wood posts as permanent or temporary supports are available from the traffic standards unit.

Supplementary panels may be attached to signs mounted on metal breakaway posts if the 7 feet of vertical clearance is maintained. Supplementary panels may be mounted on multi-post breakaway supports above the hinge point.

## Fire Danger Signs

Post mounted Fire Danger Signs shall not be placed on ODOT right of way. These signs are not MUTCD compliant, and the crash worthiness of the posts are unknown. These signs can be placed adjacent to ODOT right of way as long as they meet the outdoor advertising sign requirements. Signs already installed on ODOT right of way may remain in place until the end of their useful life, provided the sign does not create an immediate traffic hazard.

When the fire danger is considered “extreme,” a variable message sign (VMS) message may be posted, as a public service announcement. All requests for fire danger messages come to ODOT through the Oregon Department of Forestry, due to their role as the lead state agency for wildfires. The state traffic-roadway engineer must approve each posting of this type of message. These messages lose their effectiveness after time, so are only posted in extreme cases. See [VMS guidelines](#) for more information.

Figure 1: Example of a Post-mounted Fire Danger Sign



## **Chapter 3: Regulatory Signs**

### **Right of Way at Intersections (MUTCD 2B.04) on Low Volume Cross Streets**

For low-volume approaches to the highway, consider STOP (R1-1) and YIELD (R1-2) signs consistent with the provisions of the MUTCD, sections 2B.04 to 2B.10 where an engineering study or engineering judgment indicates that either of the following conditions applies:

A. An approach of a less important road with a main road where application of the normal right-of-way rule might not be readily apparent. In Oregon, at T-intersections, the right-of-way is given to the through traffic (ORS 811.277).

B. An approach that has restricted sight distance for the prevailing vehicle speeds.

Consider the following in performing an engineering study or engineering judgment about the need for STOP or YIELD control at low volume approaches to the highway.

- Engineering judgment may be sufficient for a single-stop situation (T-intersections). Perform an engineering study for multi-way stops at an intersection.
- Intersection control may be appropriate if any of the following conditions are met:
  - Traffic volumes on the minor road are more than 250 average seasonal daily traffic (ADT).
  - Approach speeds on the minor road are greater than 15 mph.
  - Adequate sight distance does not exist on all approaches to a low volume road intersection and it is impracticable to remove sight distance obstructions.
  - Two low-volume roads with similar ADT intersect, and the application of the right-of-way rule results in (or is likely to result in) driver confusion.
  - Two or more vehicle crashes have occurred within the last 3 years, or a crash investigation indicates the need for intersection control.
  - The intersection configuration is confusing, such as with “Y” intersections, and normal right-of-way expectations may be violated.

Adopted from USFS “Sign and Poster Guidelines from the Forest Service – EM 7100-15” Nov 2012.

## **EXCEPT RIGHT TURN Sign (R1-10P) (MUTCD 2B.05)**

The EXCEPT RIGHT TURN (R1-10P) sign requires state traffic engineer approval for use on state highways. See the ODOT Traffic Manual. RIGHT TURN PERMITTED WITHOUT STOPPING sign may be used until the end of its useful life. It should be replaced with R1-10P.

## **Speed Limit Sign (R2-1) (MUTCD 2B.13)**

In 2020, per Senate Bill 558, all speeds on Oregon's public roads became speed limits. SPEED LIMIT XX (R2-1) shall be used to denote the speed on all of Oregon's public roads. SPEED (OR2-1) signs currently posted may remain until the end of their useful life. They shall be replaced with SPEED LIMIT XX (R2-1).

## **Passing, Keep Right, and Slow Traffic Signs (MUTCD 2B.28, 2B.29, & 2B.30)**

The normal signing where an extra lane has been constructed to provide opportunities to pass is as follows:

1. PASSING LANE ONE MILE (D17-2 modified) – May install to advise motorists of a passing lane approximately the designated distance ahead. It should not be used in advance of a slow moving vehicle turnout.
  - Minimum Size 42" x 42".
2. 2B-28 DO NOT PASS (R4-1) – Should install approximately 1,000 feet in advance of the taper that begins the passing lane.
  - Minimum Size 36" x 48".
3. 2B-29 PASS WITH CARE (R4-2) – May install in the two-lane section approximately 1000 feet beyond the end of the taper (if sight distance is adequate to permit passing).
  - Minimum Size 24" x 30".
4. 2B-30 KEEP RIGHT EXCEPT TO PASS (R4-16) – Should install where the passing lane attains full width or at the beginning of the first skip stripe.
  - Minimum Size 36" x 48".
5. YIELD CENTER LANE TO UPHILL TRAFFIC (OR4-11) – May install facing downhill traffic at the point where the downhill no passing zone ends. A DO NOT PASS (R4-1) sign may be installed, on each side of the roadway if necessary, facing downhill traffic at the beginning of the next downhill no passing zone.



- Minimum Size 60" x 36".
6. YIELD CENTER LANE TO OPPOSING TRAFFIC (OR4-11A) – May install on level two-lane, two-way roadways with a passing lane for one direction. When used, the sign shall face the direction of travel opposite that of the passing lane. Additional signs may be installed throughout the section, but not closer together than 1/2 mile.
    - Minimum Size 60" x 36".

## Slow Vehicle Turn-out Signs (R4-12, R4-13, & R4-14) (MUTCD 2B.35)

Slow vehicle turnouts shall be signed only as shown and as listed below. The normal signing for a slow vehicle turnout is as follows:

1. SLOW VEHICLE TURNOUT 1/2 MILE (D17-7) – Used at approximately the designated distance in advance of the turnout.
  - Minimum Size 72" x 42".
2. SLOW VEHICLES MUST USE TURN-OUT AHEAD (R4-13) – Used approximately 500 feet in advance of the turnout.
  - Minimum Size 42" x 24".
3. SLOW VEHICLES MUST TURNOUT with a 45° arrow (R4-14) – Used at the beginning of the turnout.
  - Minimum Size 30" x 42".

## DO NOT ENTER Sign (R5-1) (MUTCD 2B.37)

- Minimum Size 36" x 36".

## Selective Exclusion Signs (MUTCD 2B.39)

The ONE WAY TRAFFIC FOR TRUCKS OR BUSES (OR5-11) sign should be placed ahead of or at the start of a narrow section of roadway which is not wide enough to permit two large vehicles to pass in opposite directions but will allow one large vehicle and a car or other small vehicle to pass.

The ONE WAY TRAFFIC FOR TRUCKS OR BUSES sign may be used as a rider under the NARROW BRIDGE (W5-2) sign.

- Minimum Size 36" x 36".

## **One Way Signs (R6-1 & R6-2) (MUTCD 2B.40)**

The horizontal ONE WAY sign (R6-1) should be used for signing one-way streets and roads. The vertical rectangular ONE WAY sign (R6-2) should be used for overhead mounted signs at signalized intersections.

## **Emergency Restriction Signs (R8-4, R8-7, & R8-8) (MUTCD 2B.49)**

The EMERGENCY PARKING ONLY sign (R8-4) or the EMERGENCY STOPPING ONLY sign (R8-7) may be used to reserve the shoulder for emergency use.

- Minimum Size 48" x 36".

## **Traffic Signal Signs (R10-5 through R10-30) (MUTCD 2B.53)**

Refer to the ODOT Traffic Signal Design Manual for recommended and required signs on signal poles. Each sign requires ASTM Type IX or XI background sheeting.

## **No Turn on Red Signs (R10-11 Series, R10-17a, & R10-30) (MUTCD 2B.54)**

Region traffic must approve signs from the No Turn on Red series for use on state highways.

# Oregon Regulatory Sign Details

## OR2-6a

Figure 2: Sign OR2-6a (END SPEED ZONE) Detail

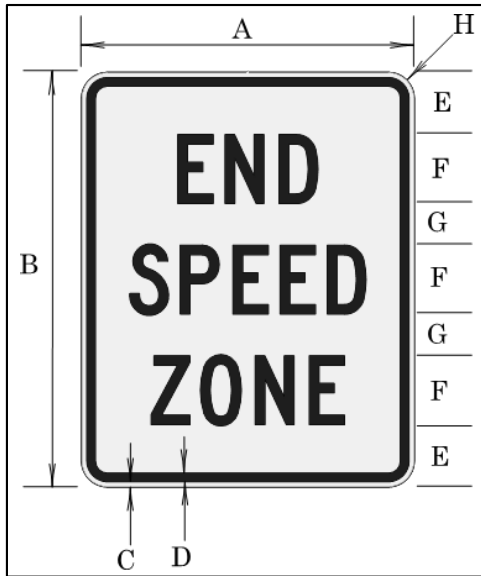

Table 3: Sign OR2-6a END SPEED ZONE Dimensions (inches)

Sign Size	A	B	C	D	E	F	G	H
Minimum	24	30	0.375	0.625	3.5	6 C	2.5	1.5
Standard	30	36	0.5	0.75	4.25	7 C	3.25	1.875
Expressway	36	48	0.625	0.875	7	8 C	5	2.25
Freeway	48	60	0.75	1.25	9	10 C	6	3

Sign Background: White, standard retroreflective sheeting.

Sign Legend: Black, non-reflective sheeting.

The END SPEED ZONE sign may be erected instead of the SPEED LIMIT 55 sign if the characteristics of the road following the lower speed zone section is 55 MPH MAX (Basic Rule under 55), but the safe speed on the road is 50 MPH or less. A speed limit sign should be placed when the characteristics of the road match the designated speed limit.

The OTC approved the OR2-6a (END SPEED ZONE) sign in January 1992. The sign was last updated in December 1997.

# OR3-5L & OR3-5R

Figure 3: Sign OR3-5L & OR3-5R (left (right) turn ONLY) Detail

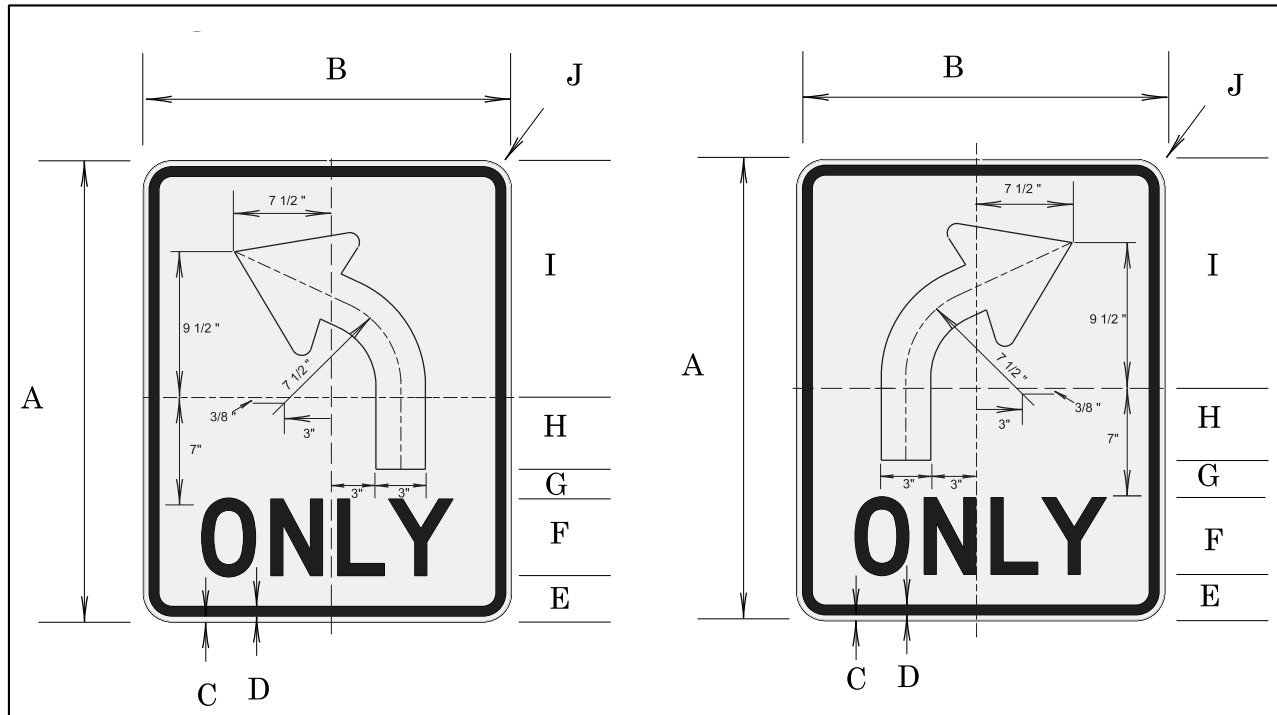

Table 4: Sign OR3-5L & OR3-5R (left (right) turn ONLY) Dimensions (inches)

A	B	C	D	E	F	G	H	I	J
30	24	0.375	0.625	3	5D	2	5	15	1.5

Sign Background: White, standard retroreflective sheeting.

Sign Legend: Black, non-reflective sheeting.

The left (right) turn ONLY sign shall only be used with, and mounted directly below, a STOP (R1-1) sign to direct the motorist through the intersection.

The OTC approved the OR3-5L (left turn ONLY) and OR3-5R (right turn ONLY) signs in January 1990. The sign was last updated in August 2006.

# OR3-5TD

Figure 4: Sign OR3-5TD (left and right arrow) Detail

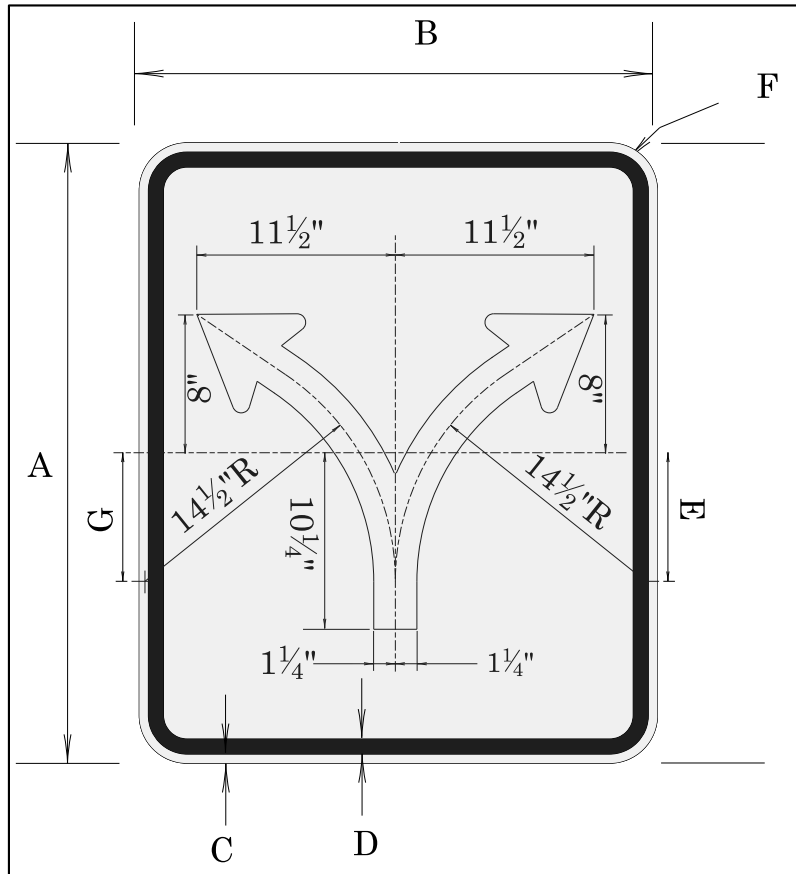

Table 5: Sign OR3-5TD (left and right arrow) Dimensions (inches)

A	B	C	D	E	F	G
36	30	0.625	0.875	7.5	2.25	7.5

Sign Background: White, type IX retroreflective sheeting.

Sign Legend: Black, non-reflective sheeting.

The left and right arrow sign is intended for overhead mounting.

The state traffic engineer approved the OR3-5TD (left and right arrow) sign in September 1998. The sign was last updated in October 2018.

# OR3-5TT

Figure 5: Sign OR3-5TT (through, left, and right arrow) Detail

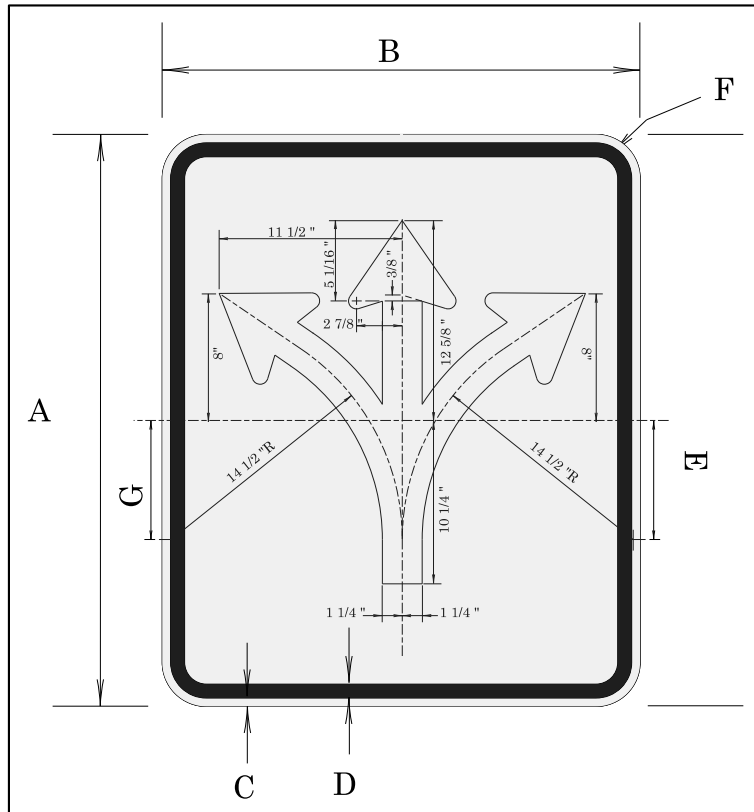

Table 6: Sign OR3-5TT (through, left, and right arrow) Dimensions (inches)

A	B	C	D	E	F	G
36	30	0.625	0.875	7.5	2.25	7.5

Sign Background: White, type IX retroreflective sheeting.

Sign Legend: Black, non-reflective sheeting.

The through, left, and right arrow sign is intended for overhead mounting.

The state traffic engineer approved the OR3-5TT (through, left and right arrow) sign September 1998. The sign was last updated in October 2018.

## OR3-7a

Figure 6: Sign OR3-7a (EXCEPT BUS) Detail

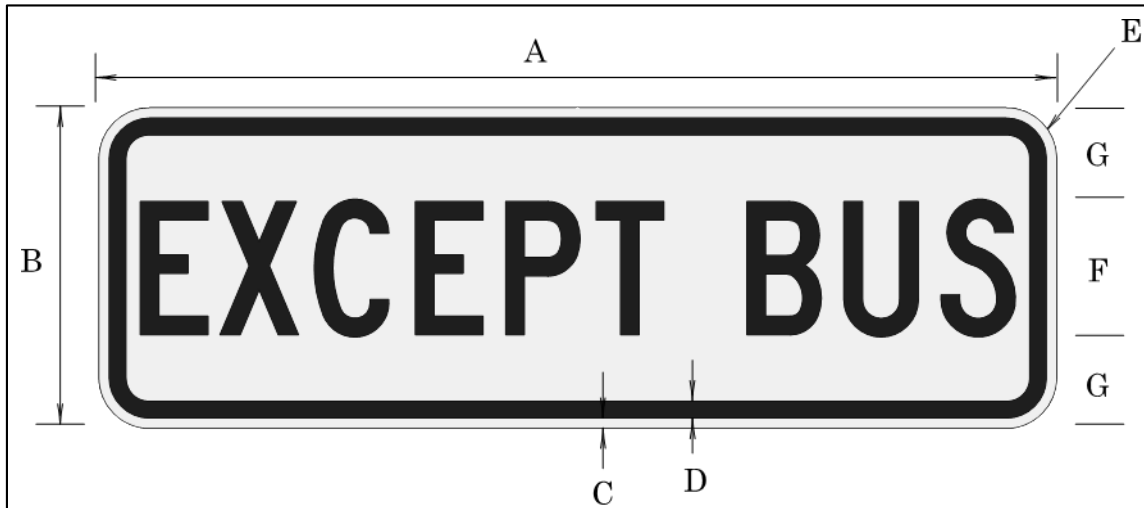

Table 7: Sign OR3-7a (EXCEPT BUS) Dimensions (inches)

Sign Size	A	B	C	D	E	F	G
Standard	30	9	0.375	0.625	1.5	4C	2.5
Special	36	12	0.375	0.625	1.5	5C	3.5

Sign Background: White, standard retroreflective sheeting

Sign Legend: Black, non-reflective sheeting

The EXCEPT BUS sign may be used at locations where a posted regulatory sign would not apply to buses. An example of a location might be where a RIGHT LANE MUST TURN RIGHT (R3-7) sign is installed at an area that a bus stop is located.

The state traffic engineer approved the OR3-7a (EXCEPT BUS) sign in May 2007.

# OR3-10a & OR3-10b

Figure 7: Sign OR3-10a & OR3-10b (Snow Lane Control) Detail

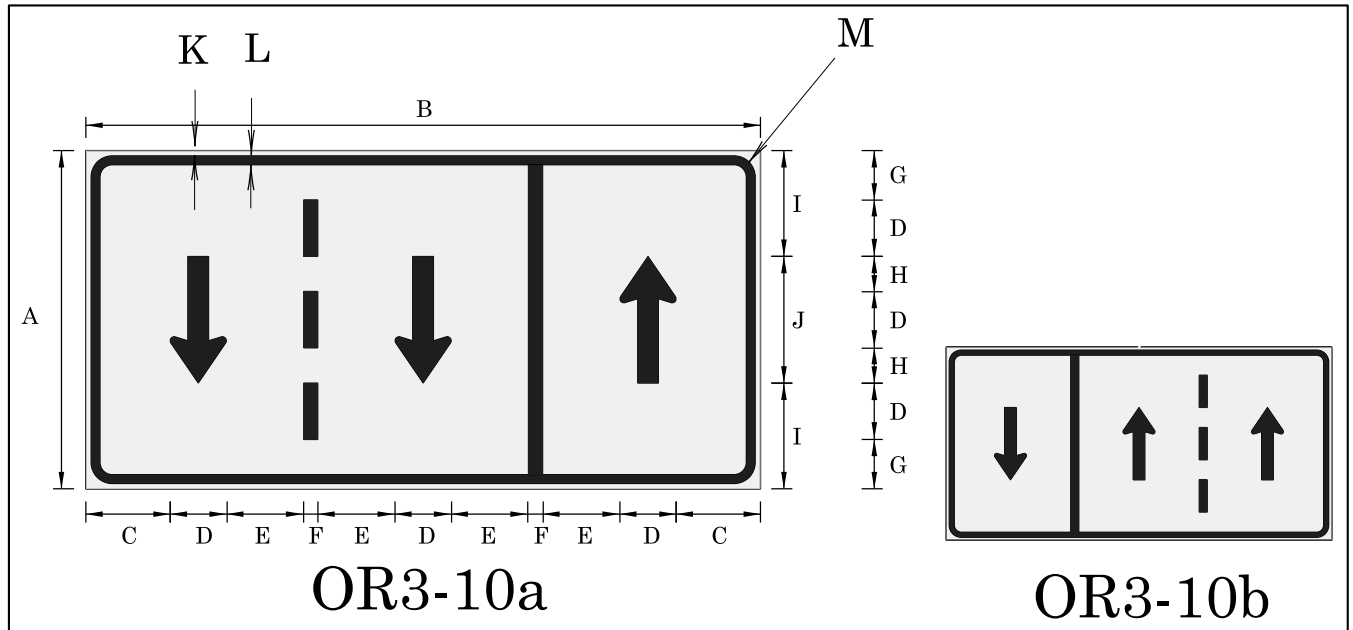

Table 8: Sign OR3-10a & OR3-10b (Snow Lane Control) Dimensions (inches)

A	B	C	D	E	F	G	H	I	J	K	L	M
48	96	12	8	11	2	7	5	15	18	0.75	1.25	3

Sign Background: White, standard retroreflective sheeting.

Sign Legend: Black, non-reflective sheeting.

The Snow Lane Control signs (above) may be used where weather conditions cover the pavement markings over a significant time period, as determined by the Region Traffic Engineer. The Snow Lane Control sign may only be used for conventional highways with two-way traffic and three lanes.

The state traffic engineer approved the OR3-10a & OR3-10b (Snow Lane Control) signs in August 2011.



# OR3-11b

Figure 8: Sign OR3-11b (LEFT LANE BUS ONLY) Detail

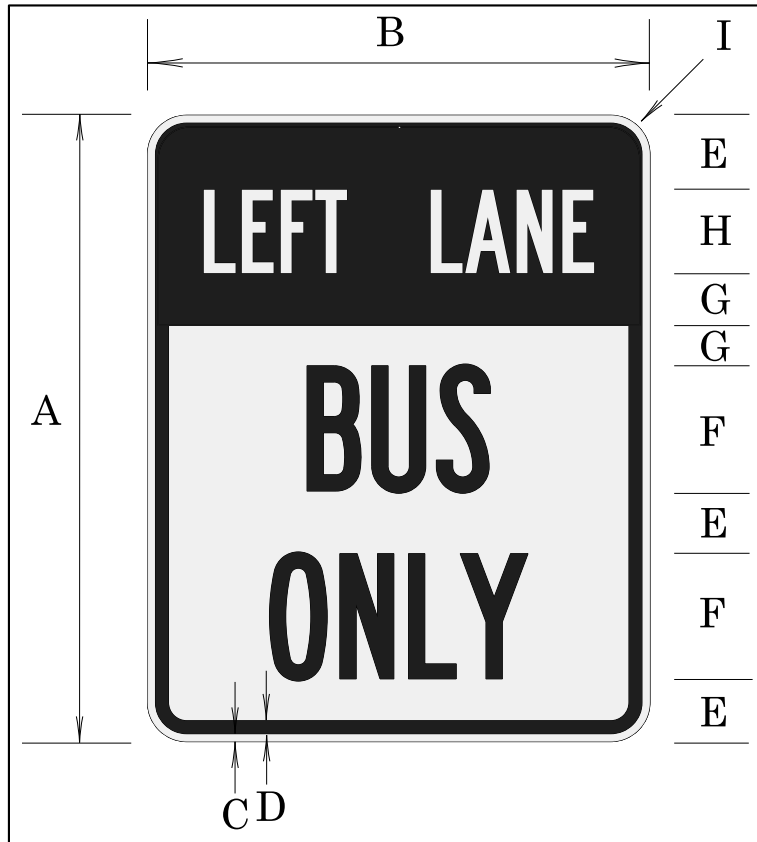

Table 9: Sign OR3-11b (LEFT LANE BUS ONLY) Dimensions (inches)

A	B	C	D	E	F	G	H	I
30	24	0.375	0.625	3	6B	2.5	4B	1.5

Top Sign Background: Black, non-reflective sheeting.

Bottom Sign Background: White, standard retroreflective sheeting.

Top Sign Legend: White, standard retroreflective sheeting.

Bottom Sign Legend: Black, non-reflective sheeting.

The LEFT LANE BUS ONLY sign shall be used to designate exclusive use of the left lane for buses only.

The state traffic engineer approved the OR3-11b (LEFT LANE BUS ONLY) sign in March 2008.

# OR3-11c

Figure 9: Sign OR3-11c (LEFT LANE BUS & LEFT TURN ONLY) Detail

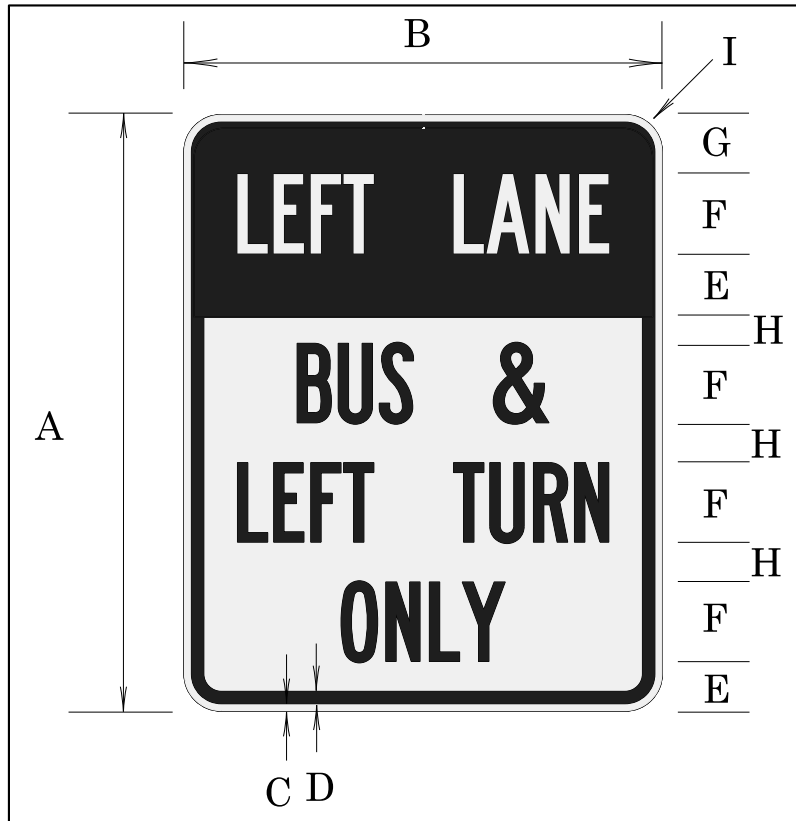

Table 10: Sign OR3-11c (LEFT LANE BUS & LEFT TURN ONLY) Dimensions (inches)

A	B	C	D	E	F	G	H	I
30	24	0.375	0.625	2.5	4B	3	2	1.5

Top Sign Background: Black, non-reflective sheeting.

Bottom Sign Background: White, standard retroreflective sheeting.

Top Sign Legend: White, standard retroreflective sheeting.

Bottom Sign Legend: Black, non-reflective sheeting.

The LEFT LANE BUS & LEFT TURN ONLY sign shall be used to designate shared use of the left lane for buses and left turning vehicles only.

The state traffic engineer approved the OR3-11c (LEFT LANE BUS & LEFT TURN ONLY) sign in March 2008.

## OR3-12

Figure 10: Sign OR3-12 (U-TURN PERMITTED) Detail

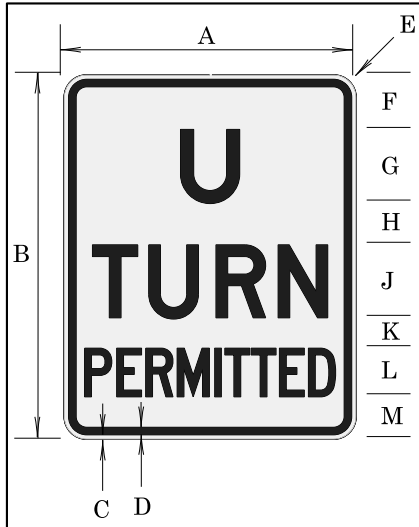

Table 11: Sign OR3-12 (U-TURN PERMITTED) Dimensions (inches)

Sign Size	A	B	C	D	E	F	G	H	J	K	L	M
Minimum	24	30	0.375	0.625	1.5	4.5	6F	3.5	4.5	1.875	4C*	3.5
Standard	30	36	0.5	0.75	1.875	1.5	8F	3.5	8C	3	5C*	4

\*Reduce spacing 50%.

Sign Background: White, standard retroreflective sheeting.

Sign Legend: Black, non-reflective sheeting.

U-Turns may be permitted at signalized intersections upon completion of an engineering study and approval by the state traffic engineer for use on state highways. Each location shall be posted with sign number OR3-12 (U-TURN PERMITTED). If U-Turns are permitted for all vehicles except trucks, post sign OR3-12 (U-TURN PERMITTED) and R5-2 (No trucks symbol sign).

U-Turns may be permitted at other locations upon completion of an engineering study and approval by the state traffic engineer. Refer to ODOT's Highway Design Manual and Traffic Signal Policy and Guidelines for more information on accommodating U-turns and the approval process.

The state traffic engineer approved the OR3-12 (U-TURN PERMITTED) sign in December 1996. The sign was last updated in September 2015.

# OR4-5

Figure 11: Sign OR4-5 (TRUCKS RIGHT TWO LANES ONLY) Detail

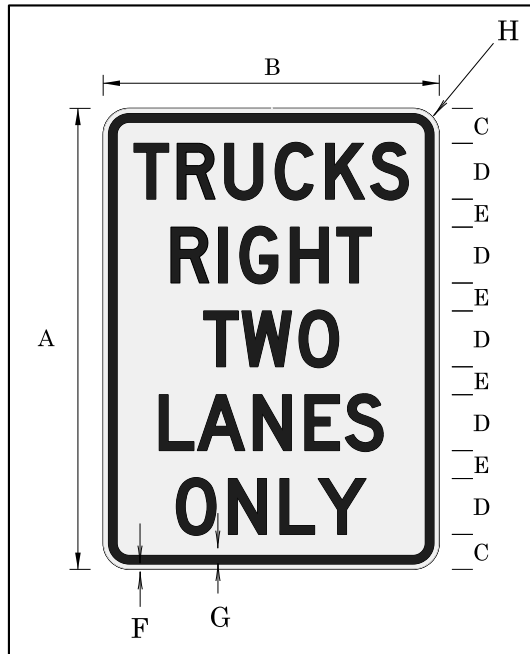

Table 12: Sign OR4-5 (TRUCKS RIGHT TWO LANES ONLY) Dimensions (inches)

A	B	C	D	E	F	G	H
66	48	5	8D	4	0.75	1.25	3

Sign Background: White, standard retroreflective sheeting.

Sign Legend: Black, non-reflective sheeting.

Use the TRUCKS RIGHT TWO LANES ONLY sign on state highways if three or more lanes in one direction have been provided and only if the state traffic engineer has approved left lane(s) restrictions to trucks. The TRUCKS RIGHT TWO LANES ONLY sign should be installed at the beginning of the restriction and repeated as often as appropriate.

The state traffic engineer approved the OR4-5 (TRUCKS RIGHT TWO LANES ONLY) sign in August 2011.

## OR4-11 & OR4-11A

Figure 12: Sign OR4-11 & OR4-11A (YIELD CENTER LANE TO UPHILL TRAFFIC) Detail

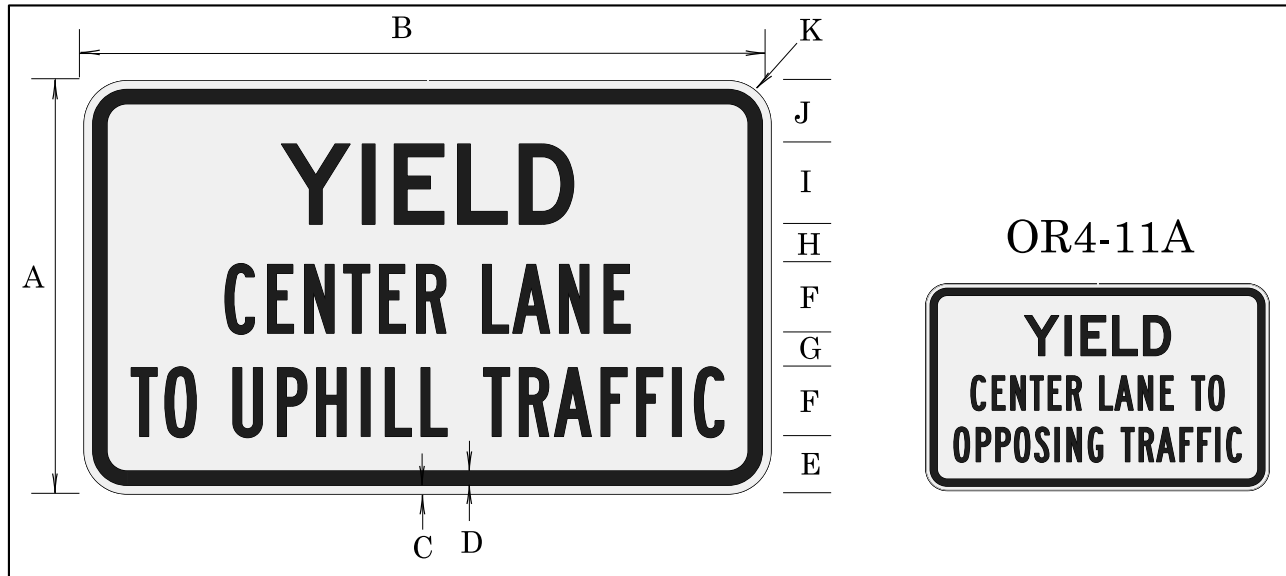

Table 13: Sign OR4-11 & OR4-11A (YIELD CENTER LANE TO UPHILL TRAFFIC) Dimensions (inches)

A	B	C	D	E	F	G	H	I	J	K
36	60	0.75	1.25	5	6B	3	3.5	7D	5.5	3

Sign Background: White, standard retroreflective sheeting.

Sign Legend: Black, non-reflective sheeting.

The YIELD CENTER LANE TO UPHILL TRAFFIC sign may be used on the downgrade with a climbing lane to inform the downhill traffic that the uphill traffic has the right-of-way in the center lane. The sign should be erected facing downhill traffic at the point where the no-passing zone for down-hill traffic terminates.

The YIELD CENTER LANE TO OPPOSING TRAFFIC sign may be installed on level two-lane, two-way facilities, where passing lanes have been constructed for one direction. The sign shall be installed where passing in both directions is permitted, and shall be positioned facing the direction of travel opposite that of the passing bay.

The OTC approved the OR4-11 & OR4-11A (YIELD CENTER LANE TO UPHILL TRAFFIC) sign in January 1990. The sign was last updated in August 2006.

## OR4-16 & OR4-17

Figure 13: Sign OR4-16 (TRUCKS-CAMPERS-TRAILERS-BUSES UNLAWFUL TO USE LEFT LANE EXCEPT WHEN PASSING) and Sign OR4-17 (TRUCKS-CAMPERS-TRAILERS-BUSES UNLAWFUL TO USE LEFT LANES EXCEPT WHEN PASSING) Detail

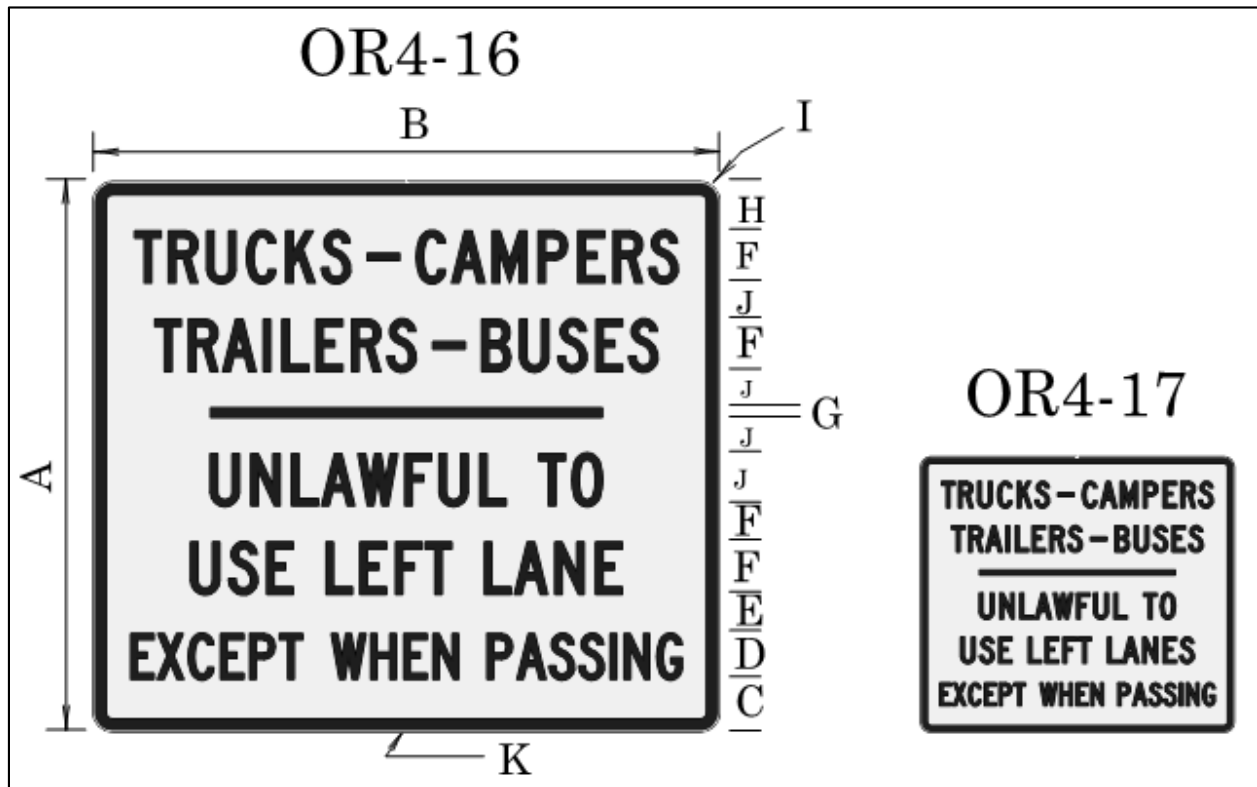

Table 14: Sign OR4-16 (TRUCKS-CAMPERS-TRAILERS-BUSES UNLAWFUL TO USE LEFT LANE EXCEPT WHEN PASSING) and Sign OR4-17 (TRUCKS-CAMPERS-TRAILERS-BUSES UNLAWFUL TO USE LEFT LANES EXCEPT WHEN PASSING) Dimensions (inches)

A	B	C	D	E	F	G	H	I	J	K
84	96	8	7C*	6	8C	1.5	7.5	3	5.5	2

\*Reduce letter spacing by 25%

Sign Background: White, standard retroreflective sheeting.

Sign Legend: Black, non-reflective sheeting.

The TRUCKS-CAMPERS-TRAILERS-BUSES UNLAWFUL TO USE LEFT LANE EXCEPT WHEN PASSING sign (OR4-16) and TRUCKS-CAMPERS-TRAILERS-BUSES UNLAWFUL TO

USE LEFT LANES EXCEPT WHEN PASSING sign (OR4-17) may be used at selected locations on four- and six-lane highways, respectively. The border has no inset.

The OTC approved the OR4-16 & OR4-17 (TRUCKS-CAMPERS-TRAILERS-BUSES UNLAWFUL TO USE LEFT LANE EXCEPT WHEN PASSING) and Sign OR4-17 (TRUCKS-CAMPERS-TRAILERS-BUSES UNLAWFUL TO USE LEFT LANES EXCEPT WHEN PASSING) signs in January 1990. The sign was last updated in February 2006.

## OR4-18 & OR4-19

Figure 14: Sign OR4-18 (STATE LAW TRUCKS-CAMPERS-TRAILERS-BUSES UNLAWFUL TO USE LEFT LANE EXCEPT WHEN PASSING ON 4 LANE HIGHWAYS) and Sign OR4-19 (STATE LAW TRUCKS-CAMPERS-TRAILERS-BUSES UNLAWFUL TO USE LEFT LANES EXCEPT WHEN PASSING ON 6 LANE HIGHWAYS) Detail

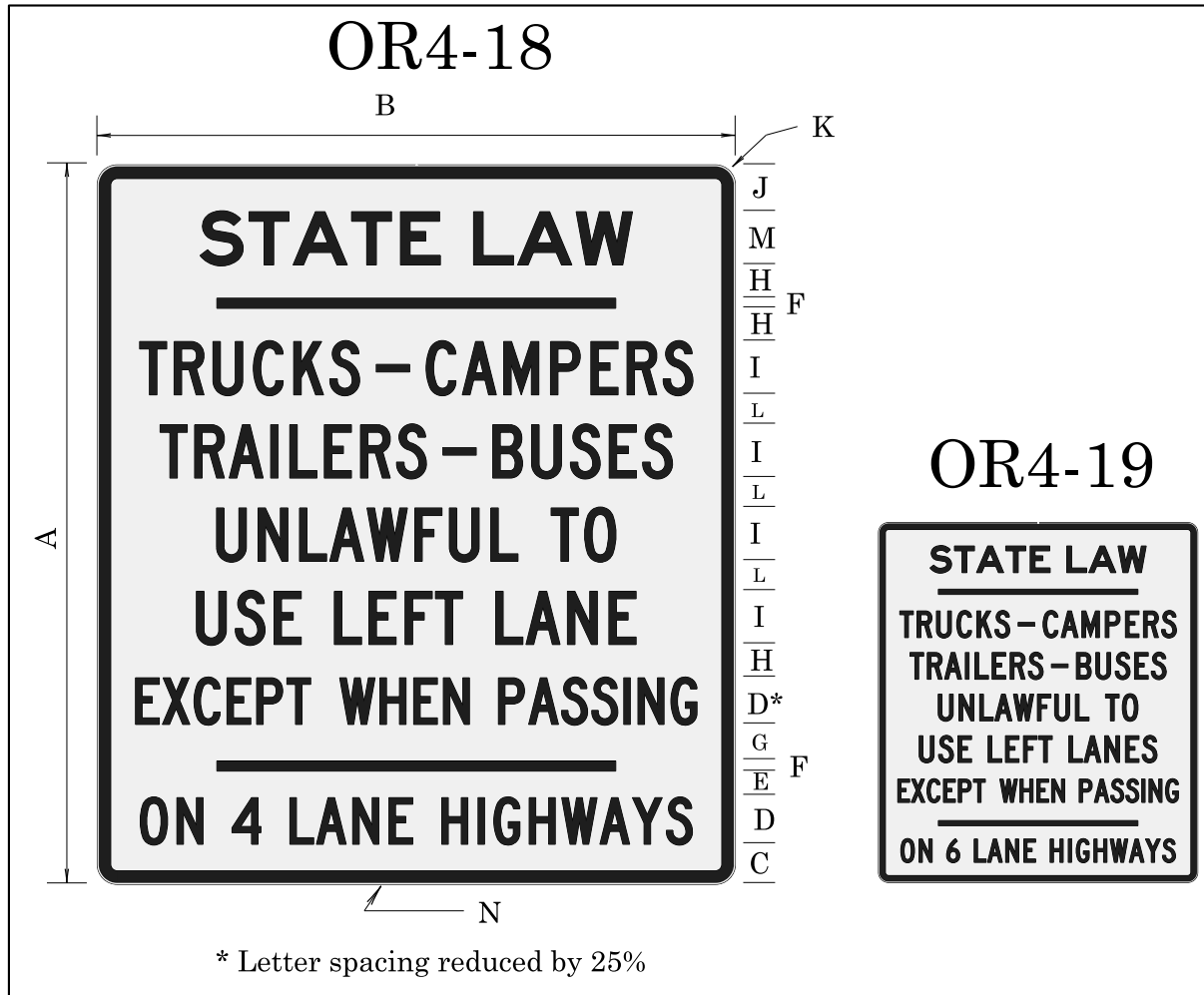

Table 15: Sign OR4-18 (STATE LAW TRUCKS-CAMPERS-TRAILERS-BUSES UNLAWFUL TO USE LEFT LANE EXCEPT WHEN PASSING ON 4 LANE HIGHWAYS) and Sign OR4-19 (STATE LAW TRUCKS-CAMPERS-TRAILERS-BUSES UNLAWFUL TO USE LEFT LANES EXCEPT WHEN PASSING ON 6 LANE HIGHWAYS) Dimensions (inches)

A	B	C	D	E	F	G	H	I	J	K	L	M	N
108	96	6	7C	4	1.5	5.5	5	8C	7	3	4.5	8E	2



Sign Background: White, standard retroreflective sheeting.

Sign Legend: Black, non-reflective sheeting.

The STATE LAW TRUCKS-CAMPERS-TRAILERS-BUSES UNLAWFUL TO USE LEFT LANE EXCEPT WHEN PASSING ON 4 LANE HIGHWAYS sign (OR4-18) and the STATE LAW TRUCKS-CAMPERS-TRAILERS-BUSES UNLAWFUL TO USE LEFT LANES EXCEPT WHEN PASSING ON 6 LANE HIGHWAYS sign (OR4-19) may be used at locations near the state line on highways leading into the state.

The OTC approved the OR4-18 (STATE LAW TRUCKS-CAMPERS-TRAILERS-BUSES UNLAWFUL TO USE LEFT LANE EXCEPT WHEN PASSING ON 4 LANE HIGHWAYS) and OR4-19 (STATE LAW TRUCKS-CAMPERS-TRAILERS-BUSES UNLAWFUL TO USE LEFT LANES EXCEPT WHEN PASSING ON 6 LANE HIGHWAYS) signs in January 1990. The sign was last updated in August 2006.

## OR4-20a

Figure 15: Sign OR4-20a (STATE LAW MOVE OVER OR SLOW DOWN) Detail

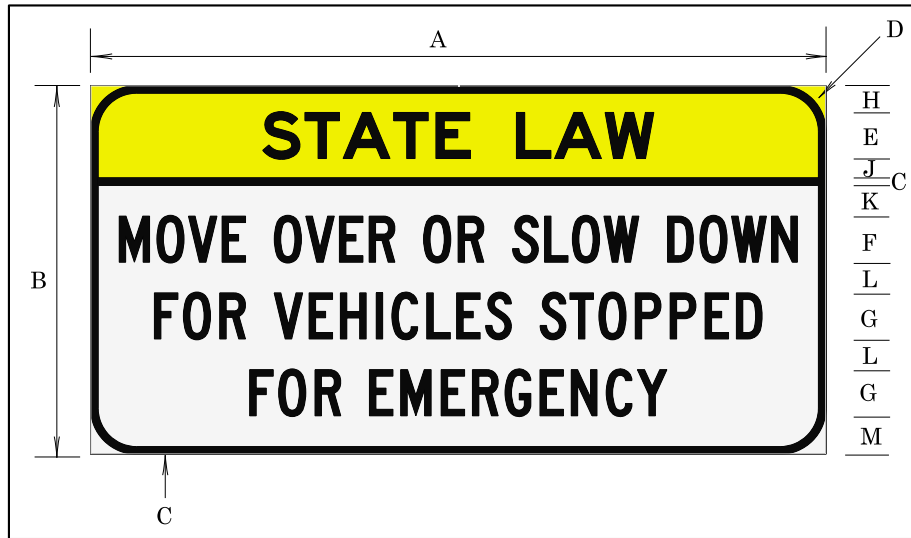

Table 16: Sign OR4-20a (STATE LAW MOVE OVER OR SLOW DOWN) Dimensions (inches)

Sign Size	A	B	C	D	E	F	G	H	J	K	L	M
Standard	96	48	1	6	6E	6C*	6C	3.5	2.5	4	4	5
FWY/EXPWY	132	66	1	6	8E	8C	8C	5	4	5.5	6	6.5

\*Reduce letter spacing 20%.

Top Sign Background: Yellow, standard retroreflective sheeting.

Bottom Sign Background: White, standard retroreflective sheeting.

Sign Legend: Black, non-reflective sheeting.

The STATE LAW MOVE OVER OR SLOW DOWN sign should be placed on state highways close to the borders to inform motorists of the state law. The signs should remain in place for approximately five years from first date of installation. They need not be replaced once they've reached their useful service life.

The SATE LAW MOVE OVER OR SLOW DOWN sign may be placed on highways anywhere in the state to remind motorists of the state law.

This sign pertains to ORS 811.147.

The state traffic engineer approved the OR3-5L (STATE LAW MOVE OVER OR SLOW DOWN) sign in October 2017.

# OR4-22

Figure 16: OR4-22 (DO NOT DRIVE BESIDE TRUCKS) Detail

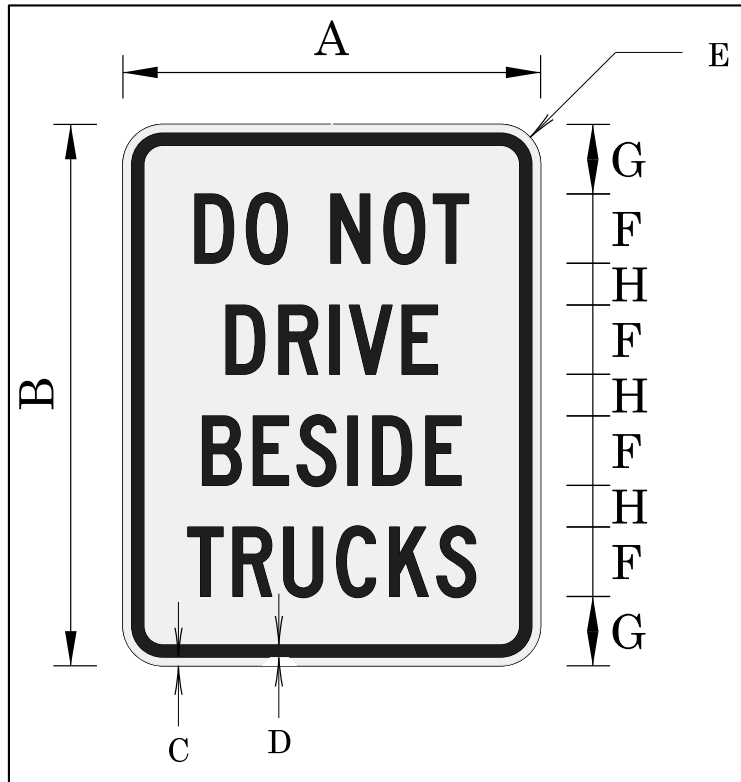

Table 17: OR4-22 (DO NOT DRIVE BESIDE TRUCKS) Dimensions (inches)

Sign Detail	A	B	C	D	E	F	G	H
Minimum	30	39	0.625	0.875	2.25	5C	5	3
Standard	33	42	0.625	0.875	2.25	6C	4.5	3

Sign Background: White, standard retroreflective sheeting.

Sign Legend: Black, non-reflective sheeting.

The DO NOT DRIVE BESIDE TRUCKS sign shall be posted at entrances to multi-lane roundabouts.

The state traffic engineer approved the OR4-22 (DO NOT DRIVE BESIDE TRUCKS) sign in January 2012.

# OR5-3A

Figure 17: Sign OR5-3A (NON-MOTORIZED VEHICLES USE NEXT EXIT) Detail

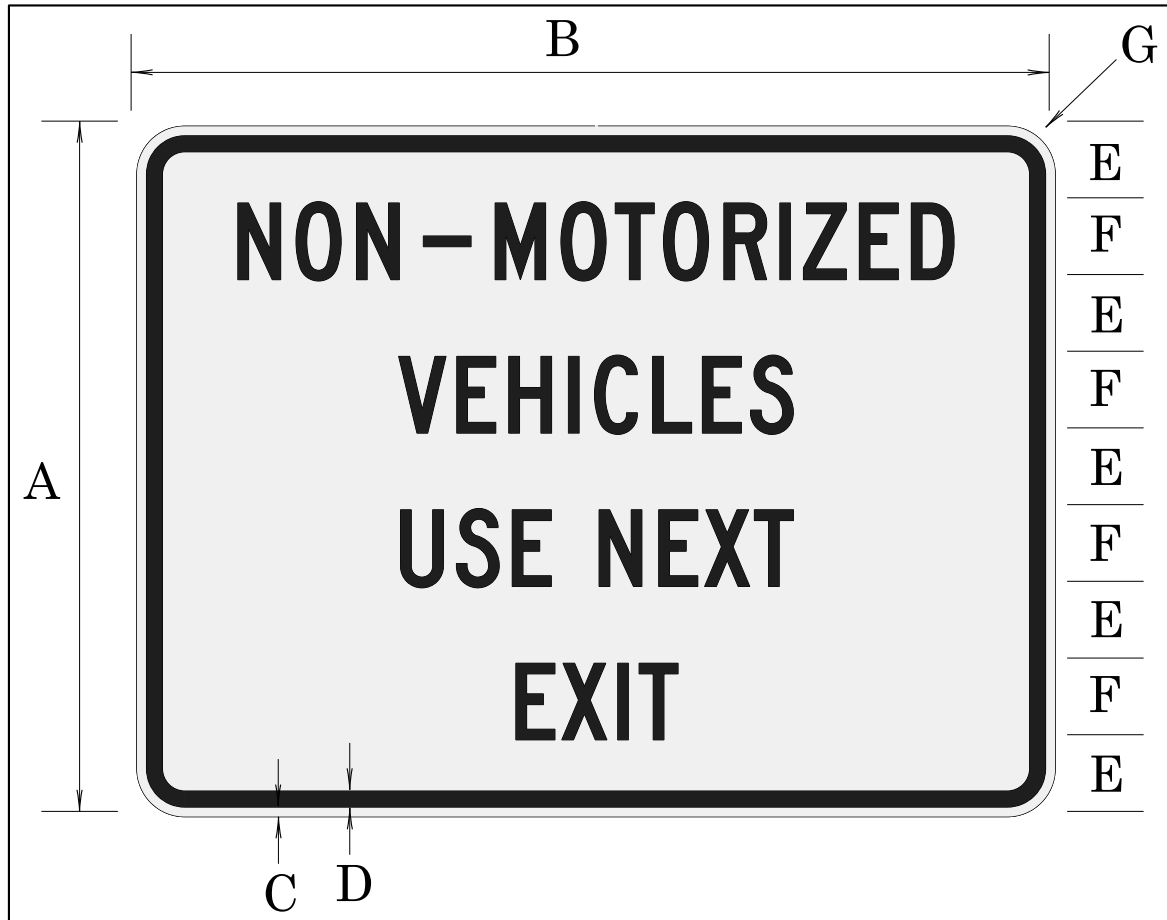

Table 18: Sign OR5-3A (NON-MOTORIZED VEHICLES USE NEXT EXIT) Dimensions (inches)

A	B	C	D	E	F	G
27	36	0.375	0.625	3	3C	1.5

Sign Background: White, standard retroreflective sheeting.

Sign Legend: Black, non-reflective sheeting.

The NON-MOTORIZED VEHICLES USE NEXT EXIT sign shall be used to instruct non-motorized vehicles to use the next exit.

The OTC approved the OR5-3A (NON-MOTORIZED VEHICLES USE NEXT EXIT) sign in June 1990. The sign was last updated in December 1997.

# OR5-11

Figure 18: Sign OR5-11 (ONE WAY TRAFFIC FOR TRUCKS AND BUSES) Detail

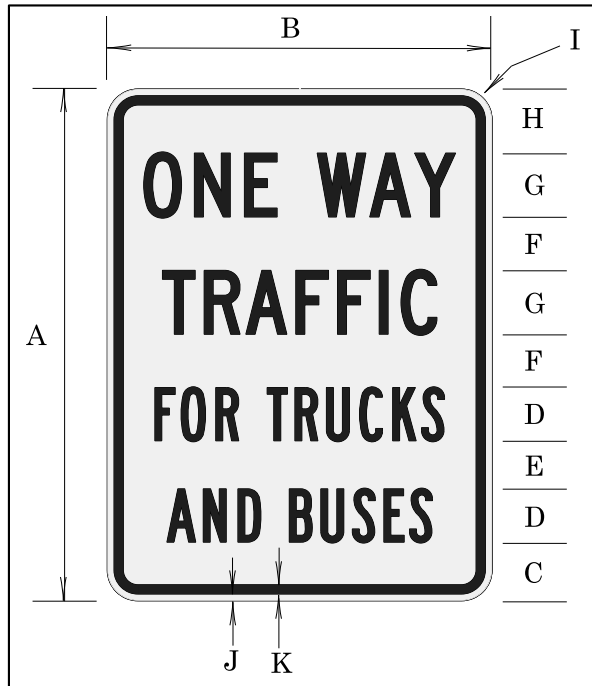

Table 19: Sign OR5-11 (ONE WAY TRAFFIC FOR TRUCKS AND BUSES) Dimensions (inches)

A	B	C	D	E	F	G	H	I	J	K
48	36	5.5	5B	4.5	5	6C	6	2.25	0.625	0.875

Sign Background: White, standard retroreflective sheeting.

Sign Legend: Black, non-reflective sheeting.

The ONE WAY TRAFFIC FOR TRUCKS AND BUSES sign should be used in advance of, or at the entrance to, a section of two-way roadway of insufficient width to permit the safe passage of a truck or a bus and another large vehicle in the opposite direction, but is of sufficient width to permit the safe two-way movement of a bus or truck, and a passenger vehicle. (OAR 734-20-120, 125, & 130).

The ONE WAY TRAFFIC FOR TRUCKS AND BUSES sign may be used as a rider under the NARROW BRIDGE sign (W5-2).

The OTC approved the OR3-5L (ONE WAY TRAFFIC FOR TRUCKS AND BUSES) sign in January 1990. The sign was last updated in December 1997.

# OR7-1

Figure 19: Sign OR7-1 (NO OVERNIGHT PARKING-PARKING PROHIBITED BETWEEN 1:00 AM AND 5:00 AM) Detail



Table 20: Sign OR7-1 (NO OVERNIGHT PARKING-PARKING PROHIBITED BETWEEN 1:00 AM AND 5:00 AM) Dimensions (inches)

A	B	C	D	E	F	G	H	I	J	K	L	M
36	48	0.875	0.625	3.5	2.5C	2	3C	2.125	0.875	5C	5	2.25

Sign Background: White, standard retroreflective sheeting.

Sign Legend: Red, standard retroreflective sheeting.

The NO OVERNIGHT PARKING - PARKING PROHIBITED BETWEEN 1:00 AM AND 5:00 AM sign may be installed at locations where an investigation indicates overnight parking creates traffic and/or personal safety hazards, sanitation problems, interferes with normal highway maintenance, or interferes with the intended use of the area.

The OTC approved the OR7-1 (NO OVERNIGHT PARKING-PARKING PROHIBITED BETWEEN 1:00AM AND 5:00 AM) sign in January 1990. The sign was last updated in December 1997.

# OR7-8c

Figure 20: Sign OR7-8c (WHEELCHAIR USER ONLY) Details

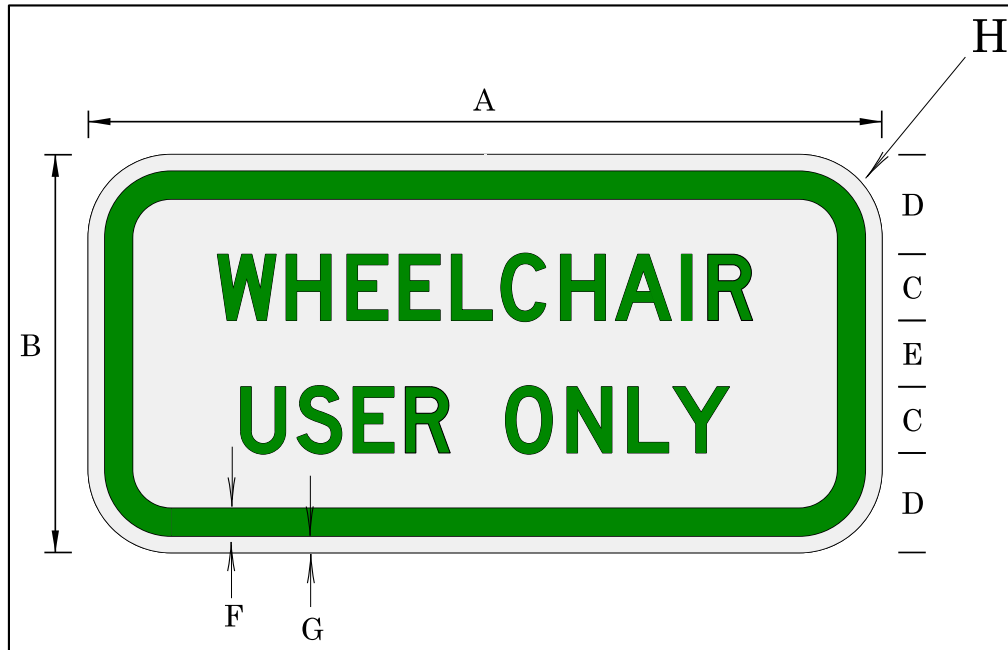

Table 21: Sign OR7-8c (WHEELCHAIR USER ONLY) Dimensions (inches)

Sign Size	A	B	C	D	E	F	G	H
Minimum	12	6	1D	1.625	0.75	0.625	0.375	1.5
Standard	18	9	1.5D	2.25	1.5	0.625	0.375	1.5

Sign Background: White, standard retroreflective sheeting.

Sign Legend: Green, standard retroreflective sheeting.

The WHEELCHAIR USER ONLY sign shall only be used with the Disabled Person Parking Sign (R7-8) and the VAN ACCESSIBLE sign (R7-8P) to designate the wheelchair user only spaces as defined in ORS 447.233.

The state traffic engineer approved the OR3-5L (WHEELCHAIR USER ONLY) sign in October 2007. The sign was last updated in July 2014.

# OR7-9

Figure 21: Sign OR7-9 (No Parking in Access Aisle) Detail



Table 22: Sign OR7-9 (No Parking in Access Aisle) Dimensions (inches)

A	B	C	D	E	F	G	H	I	J	K	L	M	N
18	12	1	10	1.5	3B	3C	2	1.5B	0.5	4	3	13	0.375

Sign Background: White, Standard Retroreflective Sheeting

Sign Legend: Red, Standard Retroreflective Sheeting; White on Blue, Standard Retroreflective Sheeting (Symbol)

The No Parking in Access Aisle sign may be used to designate an access aisle reserved for persons use parking with DMV permit. The sign should be installed in locations where “No Parking” pavement marking may not be visible regularly from snow or sand. Place sign to have direct view from the end of access aisle and, when possible, outside of accessible route.

The OTC approved the OR7-9 (No Parking in Access Aisle) sign in October 2018.



# OR7-9a

Figure 22: Sign OR7-9a Detail

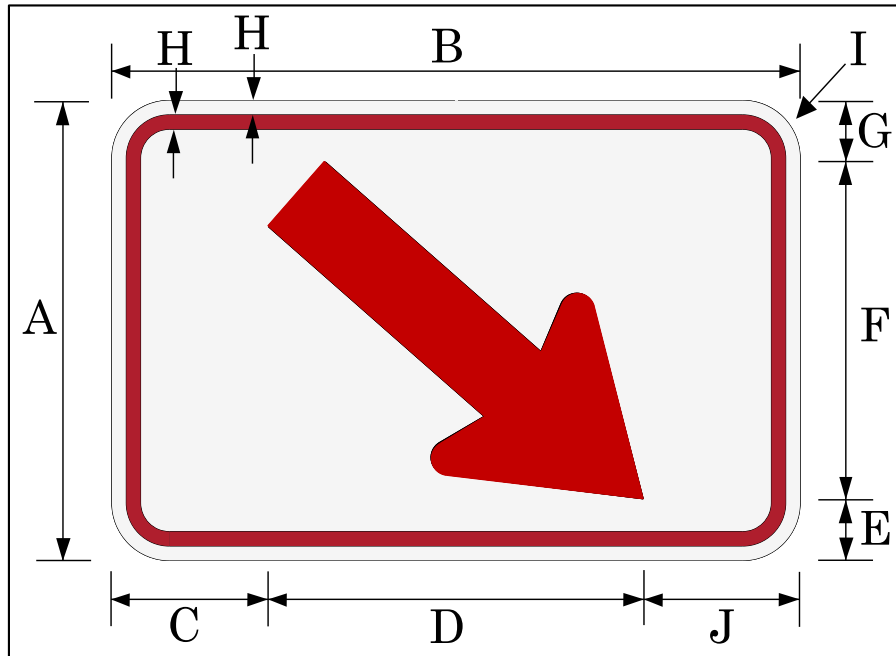

Table 23: Sign OR7-9a Dimensions (inches)

A	B	C	D	E	F	G	H	I	J
8	12	2.725	6.55	1.065	5.87	1.065	0.325	1.25	2.725

Sign Background: White, standard retroreflective sheeting.

Sign Legend: Red, standard retroreflective sheeting.

The sign OR7-9a should be used when the back of the accessible route directly behind access aisle is not available for sign placement and sign must be placed to one side of pedestrian access ramp.

The OTC approved the OR7-9a sign in October 2018.

# OR7-20

Figure 23: Sign OR7-20 (NO PARKING VEHICLES OVER X FT. HIGH) Detail

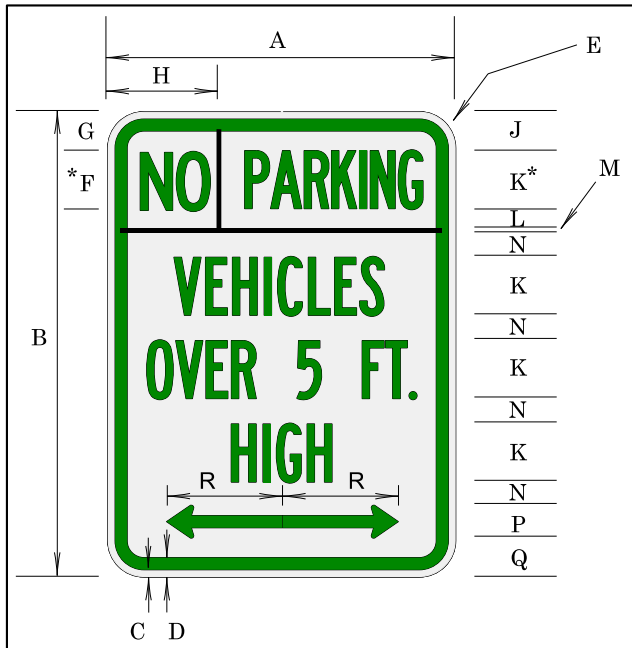

Table 24: Sign OR7-20 (NO PARKING VEHICLES OVER X FT. HIGH) Dimensions (inches)

Sign Size	A	B	C	D	E	F	G	H	J	K	L	M	N	P	Q	R
Minimum	12	18	0.375	0.375	1.5	3B	1.5	3.875	2	2B	1.25	0.25	0.75	2	1.5	4
Standard	18	24	0.375	0.625	1.5	3C	2	5.75	2	3B	1	0.25	1.25	1.75	2	6

\*Letter spacing reduced by 50%

Sign Background: White, standard retroreflective sheeting.

Sign Legend: Green, standard retroreflective sheeting.

The NO PARKING VEHICLES OVER X FT. HIGH sign should be used to post a height parking restriction established by the governing authority. Legend may be red in color if required by parking control jurisdiction.

NOTE: Use single or double-headed arrow, as appropriate.

The OTC approved the OR3-5L (NO PARKING VEHICLES OVER X FT. HIGH) sign in January 1990. The sign was last updated in February 2006.

## OR8-4A

Figure 24: Sign OR8-4A (NO PARKING FOR UNATTENDED VEHICLES) Detail



Table 25: Sign OR8-4A (NO PARKING FOR UNATTENDED VEHICLES) Dimensions (inches)

A	B	C	D	E	F	G	H	I	J
48	36	0.625	0.875	5	4C	3	4	6D	2.25

Sign Background: White, standard retroreflective sheeting.

Sign Legend: Red, standard retroreflective sheeting.

The NO PARKING FOR UNATTENDED VEHICLES sign should be where parked vehicles would create a conflict with the operation or maintenance of a highway.

The OTC approved the OR3-5L (NO PARKING FOR UNATTENDED VEHICLES) sign in January 1990. The sign was last updated in February 2006.

## OR10-3L & OR10-3R

Please note: Do not use signs OR10-3L and OR10-3R for new installations along state highways.

Figure 25: Sign OR10-3L & OR10-3R Detail

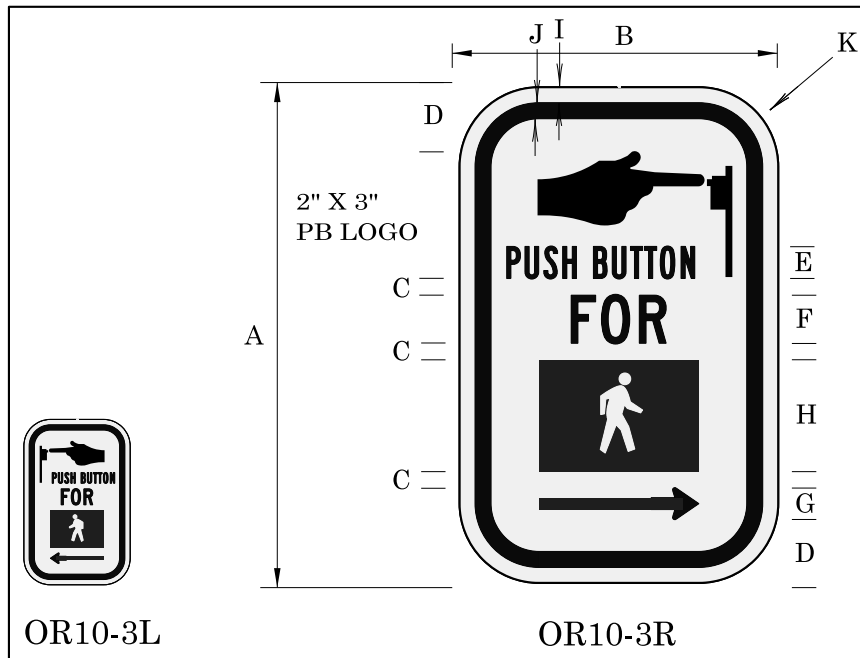

Table 26: Sign OR10-3L & OR10-3R Dimensions (inches)

A	B	C	D	E	F	G	H	I	J	K
7.75	5	0.25	1	0.5B	0.75C	0.5	1.75	0.25	0.25	1

Sign Background: White, standard retroreflective sheeting or enamel paint.

Sign Legend: Black, non-reflective sheeting or enamel paint; white pedestrian on black background.

Do not use on new installations on state highways. R10-3 shall be used for all new installations, see standard drawing TM467. Existing signs may remain in place until no longer serviceable. For symbol proportion details, see the [Standard Highway Signs](#).

The state traffic engineer approved the OR10-3L & OR10-3R signs in January 2014. The sign was last updated in October 2018.

## OR10-4bL & OR10-4bR

Please note: Do not use signs OR10-4bL and OR10-4bR for new installations along state highways.

Figure 26: OR10-4bL & OR10-4bR Detail

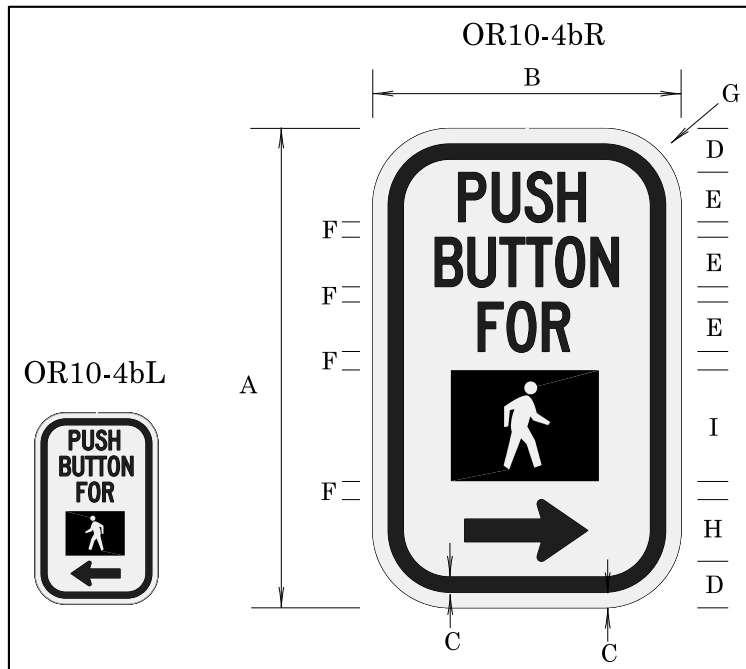

Table 27: OR10-4bL & OR10-4bR Dimensions (inches)

A	B	C	D	E	F	G	H	I
7.75	5	0.25	0.75	0.75C	0.25	1	1.25	1.75

Sign Background: White, standard retroreflective sheeting or enamel paint.

Sign Legend: Black, non-reflective sheeting or enamel paint; white pedestrian on black background.

Do not use on new installations on state highways. R10-3 shall be used for all new installations, see standard drawings TM467. Existing signs may remain in place until no longer serviceable. For symbol proportion details, see the [Standard Highway Signs](#).

The state traffic engineer approved the OR10-4bL & OR10-4bR signs in December 2011. The sign was last updated in October 2018.

# OR10-15

Figure 27: Sign OR10-15 (TURNING VEHICLES stop FOR peds) Detail

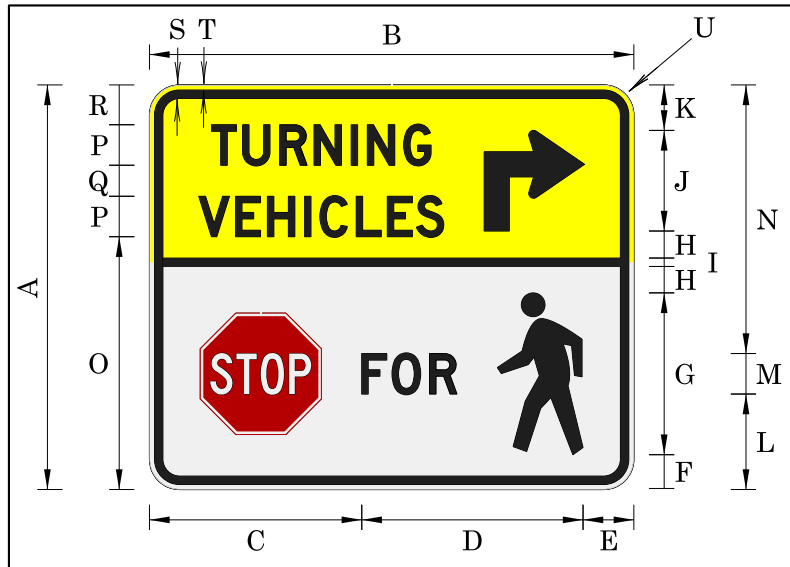

Table 28: Sign OR10-15 (TURNING VEHICLES stop FOR peds) Dimensions (inches)

A	B	C	D	E	F	G	H	I	J	
30	36	15.8	16.4	3.8	2.5	12	2	0.6	7.5	
K	L	M	N	O	P	Q	R	S	T	U
3.4	7	3D	20	18.7	3D	2.25	3	0.625	0.375	1.875

Top Sign Background: Yellow, type IX or type XI retroreflective sheeting.

Bottom Sign Background: White, type IX or type XI retroreflective sheeting.

Sign Legend: Black, non-reflective sheeting.

Stop Sign Symbol: Red, type IX retroreflective sheeting.

The TURNING VEHICLES stop FOR peds symbol sign may be used at a signalized intersection to alert right (left) turning motorists of a possibly obscured pedestrian crossing. Design may be ground or overhead mounted.

The state traffic engineer approved the OR10-15 (TURNING VEHICLES stop FOR peds) sign in November 2012. The sign was last updated in January 2016.

# OR10-15a

Figure 28: Sign OR10-15A (TURNING VEHICLES stop FOR bikes & peds) Detail

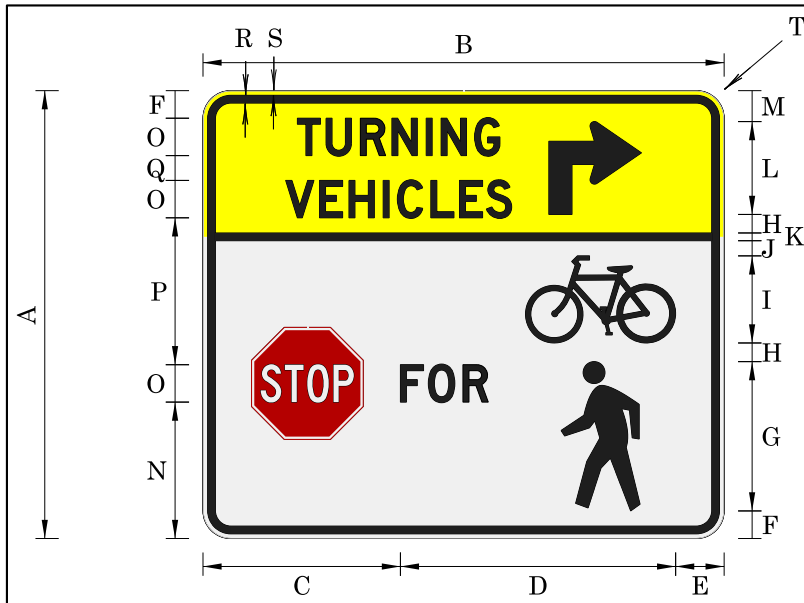

Table 29: Sign OR10-15A (TURNING VEHICLES stop FOR bikes & peds) Dimensions (inches)

A	B	C	D	E	F	G	H	I	J
36	42	15.9	22.2	3.9	2.2	12	1.5	7	1.2

K	L	M	N	O	P	Q	R	S	T
0.6	7.5	2.5	11	3D	11.8	2	0.625	0.375	1.875

Top Sign Background: Yellow, type IX or type XI retroreflective sheeting.

Bottom Sign Background: White, type IX or type XI retroreflective sheeting.

Sign Legend: Black, non-reflective sheeting.

Stop Sign Symbol: Red, type IX or type XI retroreflective sheeting.

The TURNING VEHICLES stop FOR bikes & peds symbol sign may be used at a signalized intersection to alert right (left) turning motorists of a possibly obscured pedestrian crossing. Design may be ground or overhead mounted.

The OTC approved the OR3-5L (TURNING VEHICLES stop FOR bikes & peds) sign in December 2011. The sign was last updated in January 2016.

# OR10-15b

Figure 29: OR10-15b (TURNING VEHICLES yield TO bikes) Detail

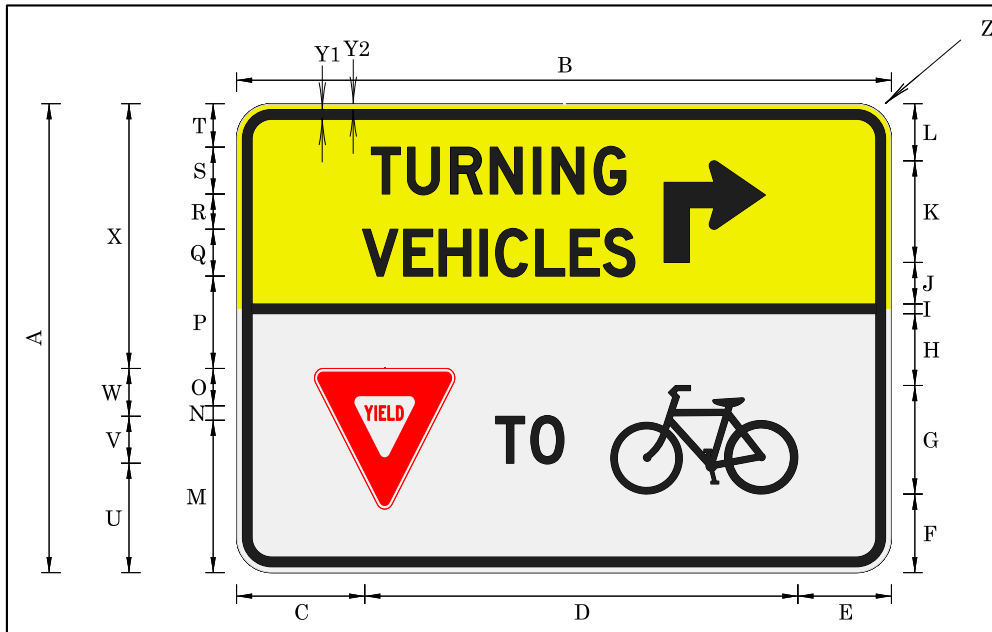

Table 30: OR10-15b (TURNING VEHICLES yield TO bikes) Dimensions (inches)

A	B	C	D	E	F	G	H	I	J	K	L	M	N
30	42	8.5	27.8	6	5	6.9	4.6	0.6	2.7	6.5	3.7	9.7	0.9C

O	P	Q	R	S	T	U	V	W	X	Y1	Y2	Z
2.4	5.9	3D	2.3	3D	2.8	7	3D	3.1	16.9	0.63	0.38	1.88

Top Sign Background: Yellow, type IX or type XI retroreflective sheeting.

Bottom Sign Background: White, type IX or type XI retroreflective sheeting.

Sign Legend: Black, non-reflective sheeting.

Yield Sign Symbol: Red, type IX or type XI retroreflective sheeting.

The TURNING VEHICLES yield TO bikes symbol sign may be used at a signalized intersection to alert right (left) turning motorists of a possibly obscured crossing. Design may be ground or overhead mounted.

The state traffic engineer approved the OR10-15b (TURNING VEHICLES yield TO bikes) sign in December 2011. The sign was last updated in January 2016.



## OR10-25L & OR10-25R

Please note: Do not use signs OR10-25L and OR10-25R for new installations along state highways.

Figure 30: Sign OR10-25L & OR10-25R Detail

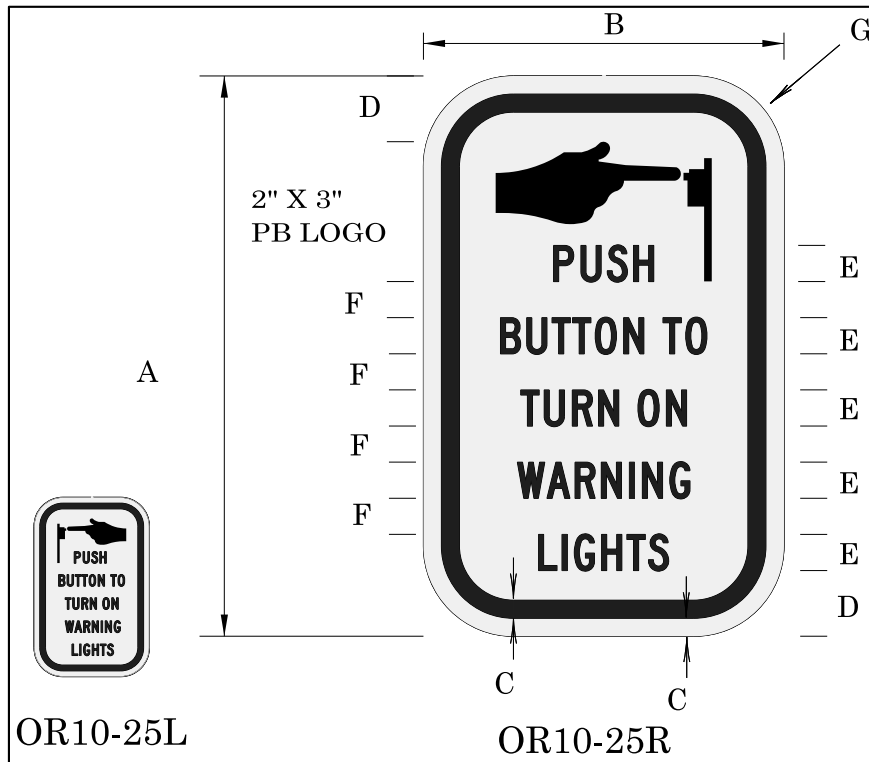

Table 31: Sign OR10-25L & OR10-25R Dimensions (inches)

A	B	C	D	E	F	G
7.75	5	0.25	0.875	0.5C	0.5	1

Sign Background: White, standard retroreflective sheeting or enamel paint.

Sign Legend: Black, non-reflective sheeting or enamel paint.

Do not use on new installations on state highways. R10-25R or R10-25L shall be used for all new installations, see standard details DET 4436, DET 4437, and DET 4438. Existing signs may remain in place until no longer serviceable.

Note: See ODOT Traffic Manual for more information on Pedestrian Activated Warning Lights.

The state traffic engineer approved the OR10-25L & OR10-25R signs in January 2014. The sign was last updated in October 2018.

## OR10-32L & OR10-32R

Figure 31: Sign OR10-32L & OR10-32R (PUSH BUTTON FOR Peds HOLD FOR 2 SECONDS FOR EXTRA CROSSING TIME) Detail

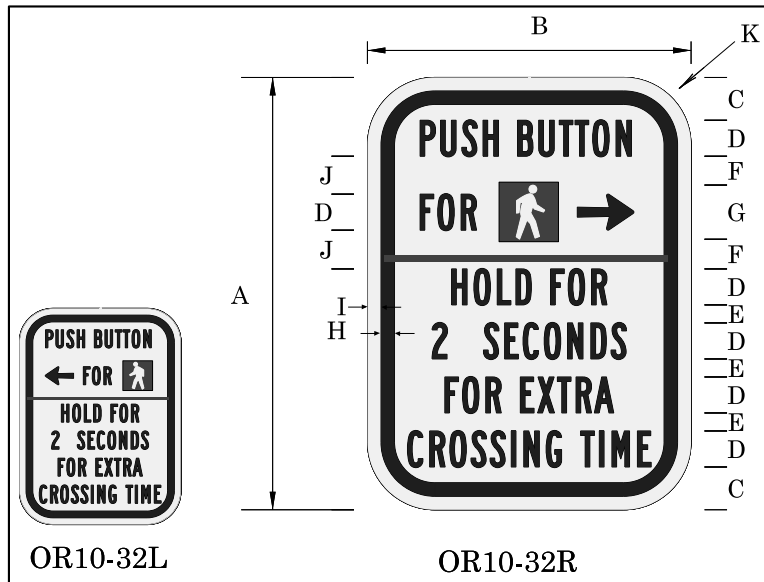

Table 32: Sign OR10-32L & OR10-32R (PUSH BUTTON FOR Peds HOLD FOR 2 SECONDS FOR EXTRA CROSSING TIME) Dimension (inches)

A	B	C	D	E	F	G	H	I	J	K
12	9	1.25	1B	0.5	0.75	1.5 LOGO	0.375	0.375	1	1.5

Sign Background: White, standard retroreflective sheeting.

Sign Legend: Black, non-reflective sheeting; white pedestrian on black background.

Use the PUSH BUTTON FOR Peds HOLD FOR 2 SECONDS FOR EXTRA CROSSING TIME sign for instances where signal timing allows the option of extra crossing time for pedestrians. OR10-32 is an acceptable alternative to using R10-3 in conjunction with the R10-32P rider. It provides the same message on a single substrate of a size consistent with ODOT push button application.

The state traffic engineer approved the OR3-5L (left turn ONLY) sign in September 2013. The sign was last updated in July 2014.

# OR11-4a

Figure 32: Sign OR11-4a (ROAD CLOSED TO THRU TRAFFIC LOCAL ACCESS ONLY) Detail

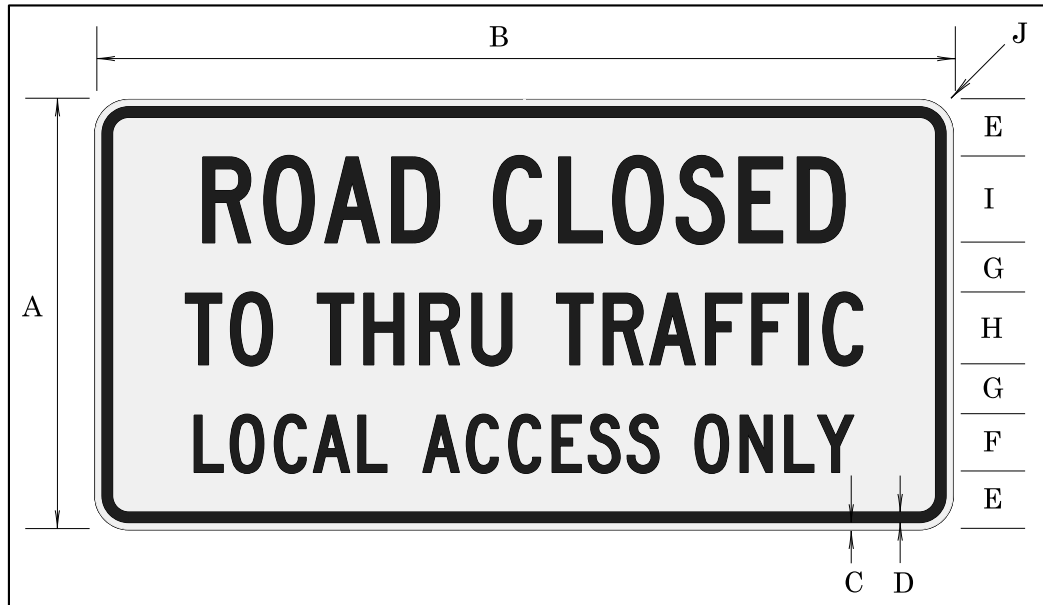

Table 33: Sign OR11-4a (ROAD CLOSED TO THRU TRAFFIC LOCAL ACCESS ONLY) Dimensions (inches)

A	B	C	D	E	F	G	H	I	J
30	60	0.5	0.75	4	4C	3.5	5C	6C	1.875

Sign Background: White, standard retroreflective sheeting.

Sign Legend: Black, non-reflective sheeting.

Use the ROAD CLOSED TO THRU TRAFFIC LOCAL ACCESS ONLY sign on construction projects in urban areas where alternate traffic routes are available.

The state traffic engineer approved the OR11-4a (ROAD CLOSED TO THRU TRAFFIC LOCAL ACCESS ONLY) sign in March 1994. The sign was last updated in October 1998.

# OR12-5

Figure 33: Sign OR12-5 (WEIGHT LIMIT REDUCED) Detail

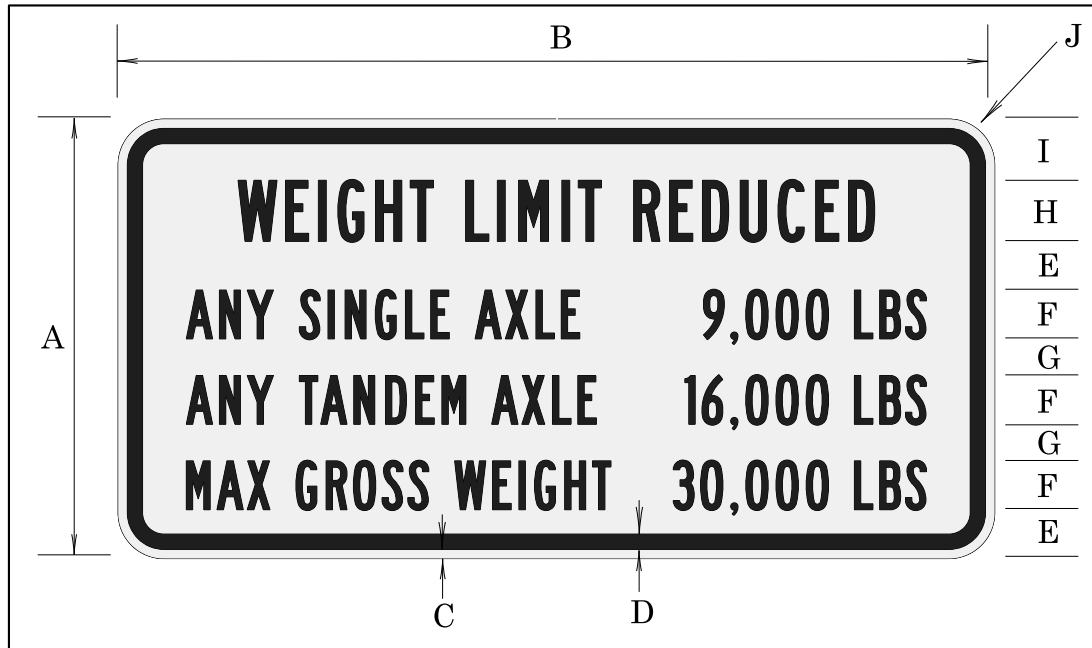

Table 34: Sign OR12-5 (WEIGHT LIMIT REDUCED) Dimensions (inches)

A	B	C	D	E	F	G	H	I	J
36	72	0.75	1.25	4	4B	3	5B	5	3

Sign Background: White, standard retroreflective sheeting.

Sign Legend: Black, non-reflective sheeting.

Use the standard WEIGHT LIMIT REDUCED sign to indicate weight limits established on a section of roadway, per the provisions of ORS 810.030 by the authority of the OTC or local authorities in their respective jurisdictions. This loading limitation applies to structures having short spans where the deck and stringers are the limiting elements and the concentrated load imposed by the axle is the major concern. This includes structures with weight limits "reduced" to the legal limit.

The OTC approved the OR12-5 (WEIGHT LIMIT REDUCED) sign in January 1990. The sign was last updated in November 2012.

# OR12-5d

Figure 34: Sign OR12-5d (WEIGHT LIMITS (Class A)) Detail

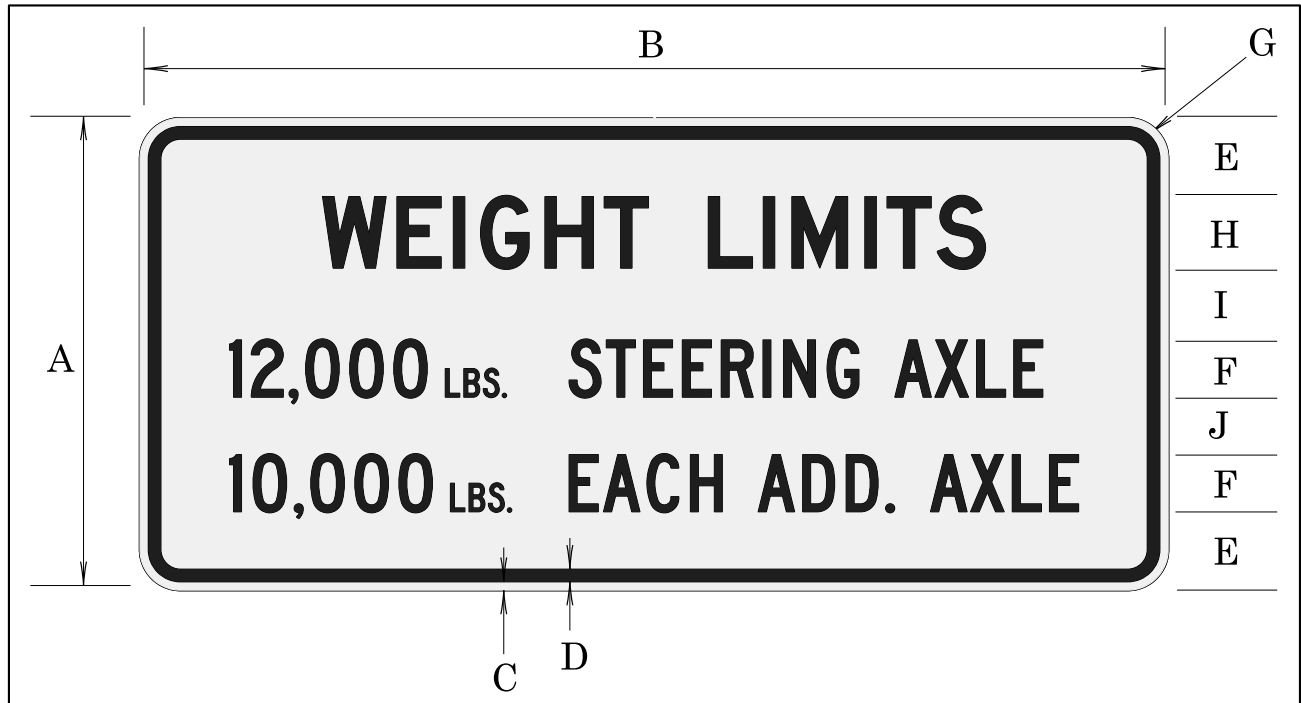

Table 35: Sign OR12-5d (WEIGHT LIMITS (Class A)) Dimensions (inches)

A	B	C	D	E	F	G	H	I	J
33	72	0.625	0.875	5.5	4C-2C	2.25	5D	5	4

Sign Background: White, standard retroreflective sheeting.

Sign Legend: Black, non-reflective sheeting.

The WEIGHT LIMITS (Class A) sign shall be used to post the limits of a Class A weight limit established on a section of the highway.

This sign is in support of OAR 734-050-0090.

The state traffic engineer approved the OR12-5d (WEIGHT LIMITS (Class A)) sign in May 1996. The sign was last updated in December 1997.

# OR12-5e

Figure 35: Sign OR12-5e (WEIGHT LIMIT CLASS A X MILES AHEAD) Detail

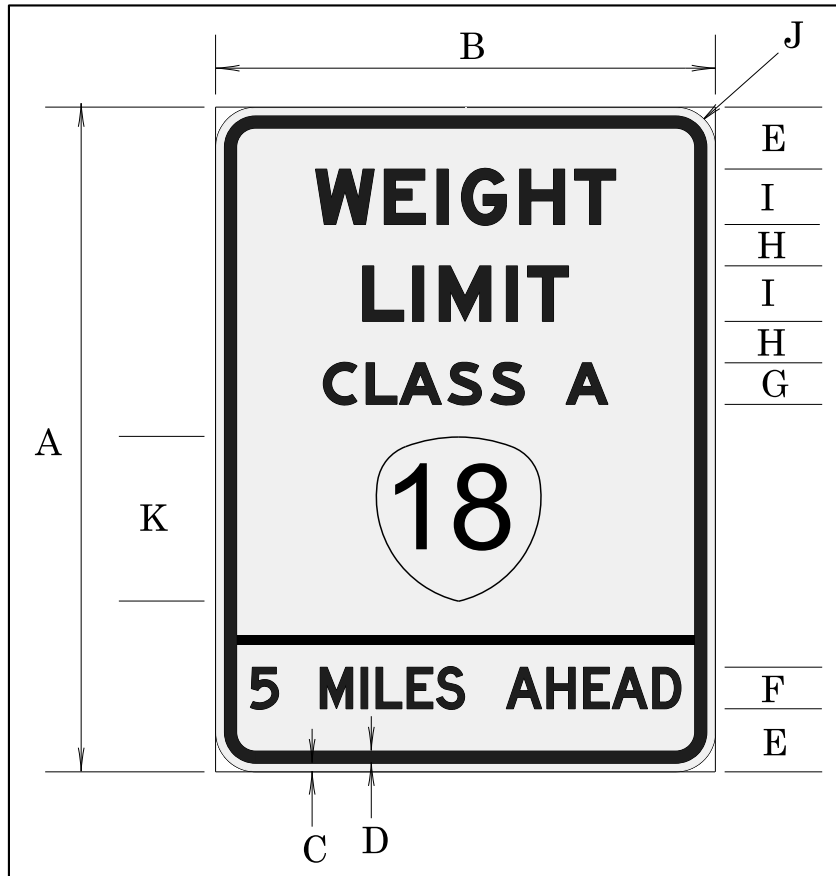

Table 36: Sign OR12-5e (WEIGHT LIMIT CLASS A X MILES AHEAD) Dimensions (inches)

A	B	C	D	E	F	G	H	I	J	K
48	36	0.625	0.875	4.5	3D	3EM	3	4EM	2.25	12

Sign Background: White, standard retroreflective sheeting.

Sign Legend: Black, non-reflective sheeting.

The standard WEIGHT LIMIT CLASS A X MILES AHEAD sign shall be used to inform the motorist of an established Class A weight limit on a section of highway.

This sign is in support of OAR 734-050-0090.

The state traffic engineer approved the OR12-5e (WEIGHT LIMIT CLASS A X MILES AHEAD) sign in May 1996. The sign was last updated in December 1997.

# OR12-5f

Figure 36: OR12-5f (WEIGHT LIMIT REDUCED FOR LEGAL LOADS) Detail

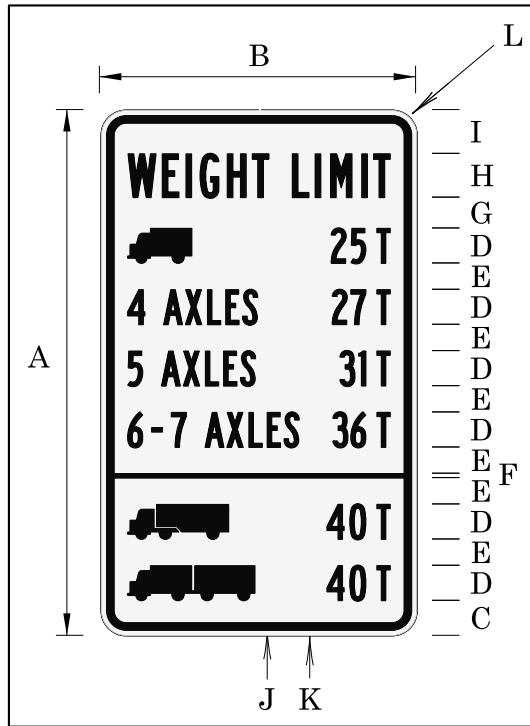

Table 37: OR12-5f (WEIGHT LIMIT REDUCED FOR LEGAL LOADS) Dimensions (inches)

A	B	C	D	E	F	G	H	I	J	K	L
60	36	4	4B	3	0.5	3.5	5B	5	0.875	0.625	2.25

Sign Background: White, standard retroreflective sheeting.

Sign Legend: Black, non-reflective sheeting.

The WEIGHT LIMIT REDUCED FOR LEGAL LOADS sign shall be used when there is a need to limit the traditional legal loads and also the single unit vehicles (solo vehicles or any vehicle in combination). Due to the concentrated axle groups that the single unit vehicles have, the sign typically shows the three text lines for the 4, 5, and 6-7 axle configurations. However, only show those single unit vehicles that have weight limits. Local agencies have flexibility to combine other axle groups when the difference in weight limit is small, or there are specific site concerns limiting the size of the sign.

The state traffic engineer approved the OR12-5f (WEIGHT LIMIT REDUCED FOR LEGAL ROADS) sign in January 2014. The sign was last updated in September 2015.

# OR12-5g

Figure 37: Sign OR12-5g (WEIGHT LIMIT REDUCED FOR SINGLE UNIT VEHICLES ONLY) Detail

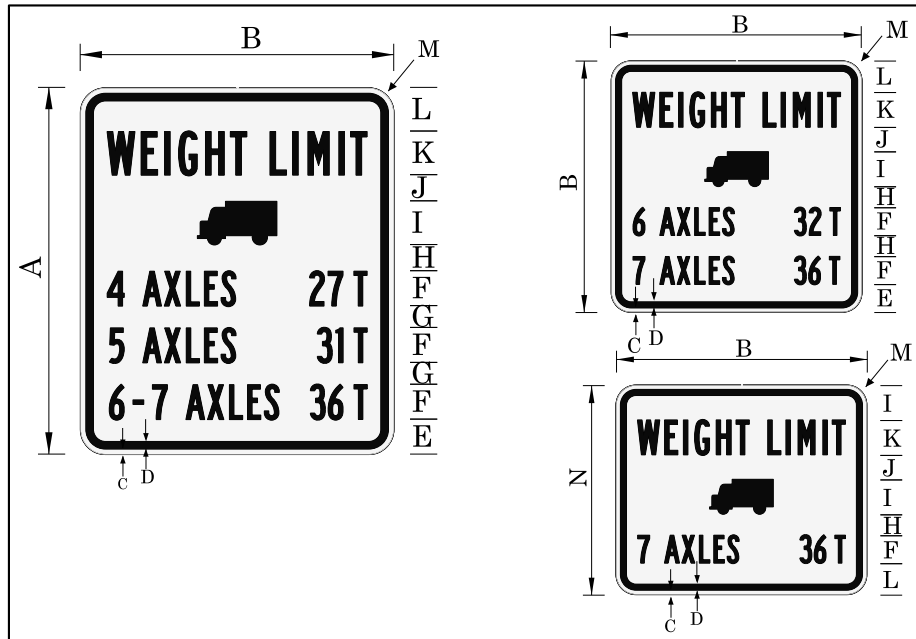

Table 38: Sign OR12-5g (WEIGHT LIMIT REDUCED FOR SINGLE UNIT VEHICLES ONLY) Dimensions (inches)

A	B	C	D	E	F	G	H	I	J	K	L	M	N
42	36	0.625	0.875	4	4B	2.5	3	5	3.5	5B	4.5	2.25	30

Sign Background: White, standard retroreflective sheeting.

Sign Legend: Black, non-reflective sheeting.

The WEIGHT LIMIT REDUCED FOR SINGLE UNIT VEHICLES ONLY sign shall be used when there is a desire to specify a load limit for single unit vehicles (solo vehicles or any vehicle in combination) when there is no need to limit the other legal loads. Only show vehicles with weight limits. The text is limited to three lines; if there is a need to limit all four configurations, the preferred option is to combine the 6-7 axle weight limits into one line. However, local agencies have flexibility to combine other axle groups when the difference in weight limit is small, or there are specific site concerns limiting the size of the sign.

The state traffic engineer approved the OR12-5g (WEIGHT LIMIT REDUCED FOR SINGLE UNIT VEHICLES ONLY) sign in January 2014. The sign was last updated in September 2015.



# OR12-5h

Figure 38: Sign OR12-5h (WEIGHT LIMIT REDUCED FOR EMERGENCY VEHICLES ONLY) Detail

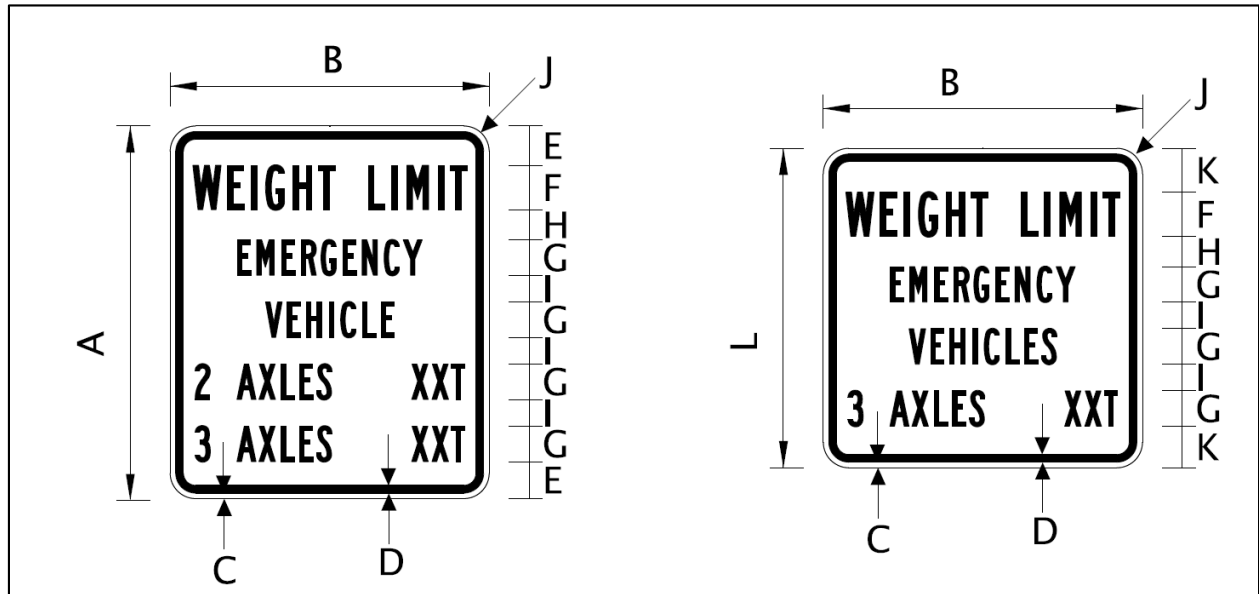

Table 39: Sign OR12-5h (WEIGHT LIMIT REDUCED FOR EMERGENCY VEHICLES ONLY) Dimensions (inches)

Sign Size	A	B	C	D	E	F	G	H	I	J	K	L
Minimum	42	36	0.625	0.875	4.3	5B	4B	3.4	3	2.25	4.8	36
Freeway	72	78	0.75	1.25	4	8C	8C	6	6	3	5	60

Sign Background: White, standard retroreflective sheeting.

Sign Legend: Black, non-reflective sheeting.

The WEIGHT LIMIT REDUCED FOR EMERGENCY VEHICLES ONLY sign shall be used when there is a desire to specify a load limit for emergency vehicles when there is no need to limit other legal loads. Only show axle numbers that have weight limits.

The text is limited to two lines, as most emergency vehicles do not have more than three axles. However, if emergency vehicles start to have more than three axles, causing a weight restriction for a structure, another line can be added to the sign.

The state traffic engineer approved the OR12-5h (WEIGHT LIMIT REDUCED FOR EMERGENCY VEHICLES ONLY) sign in September 2021.

# OR12-5i

Figure 39: Sign OR12-5i (WEIGHT LIMIT REDUCED EMERGENCY VEHICLES rider) Detail

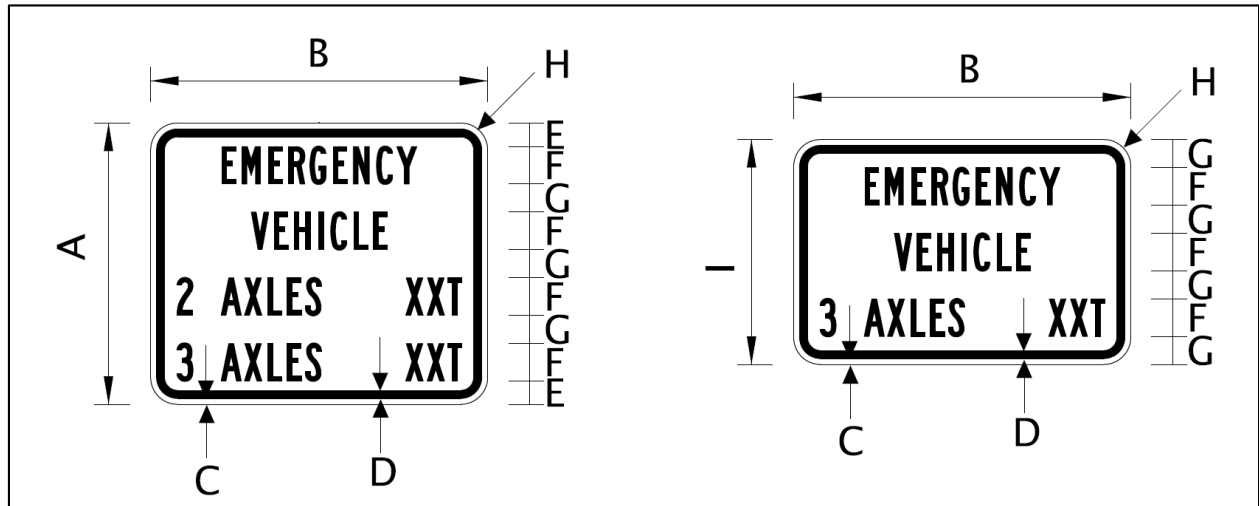

Table 40: Sign OR12-5i (WEIGHT LIMIT REDUCED FOR EMERGENCY VEHICLES rider) Dimensions (inches)

Sign Size	A	B	C	D	E	F	G	H	I
Minimum	30	36	0.625	0.875	2.5	4B	3	2.25	24
Freeway	60	78	0.75	1.25	5	8C	6	3	48

Sign Background: White, standard retroreflective sheeting.

Sign Legend: Black, non-reflective sheeting.

The WEIGHT LIMIT REDUCED FOR EMERGENCY VEHICLES rider sign shall be used in conjunction with other weight limit signs, when there is a desire to specify a load limit for emergency vehicles and also limit the other legal loads with another sign. Only show axle numbers that have weight limits.

The text is limited to two lines, as most emergency vehicles do not have more than three axles. However, if emergency vehicles start to have more than three axles, causing a weight restriction for a structure, another line can be added to the sign.

The state traffic engineer approved the OR12-5i (WEIGHT LIMIT REDUCED FOR EMERGENCY VEHICLES rider) sign in September 2021.

# OR12-6

Figure 40: Sign OR12-6 (XX TON BRIDGE WEIGHT LIMIT XX MILES AHEAD) Detail

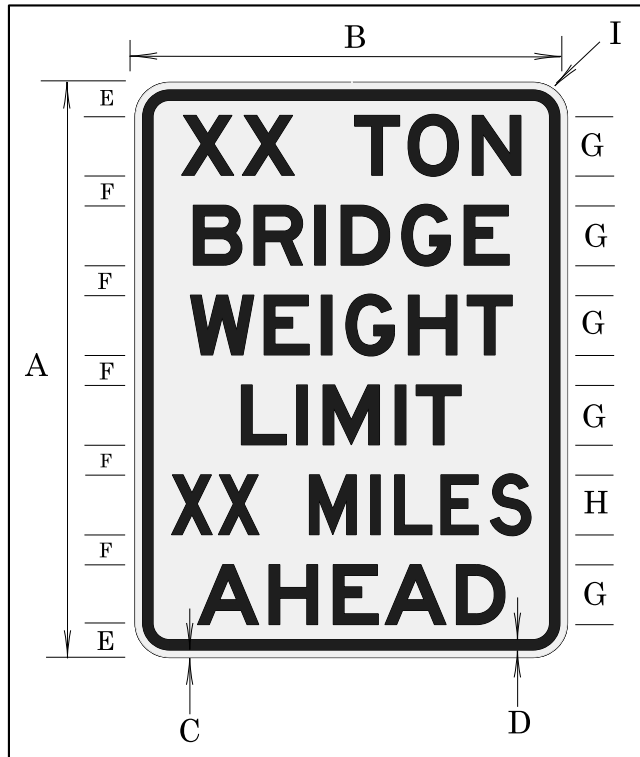

Table 41: Sign OR12-6 (XX TON BRIDGE WEIGHT LIMIT XX MILES AHEAD) Dimensions (inches)

A	B	C	D	E	F	G	H	I
48	36	0.625	0.875	2.75	2.5	5E	5D	2.25

Sign Background: White, standard retroreflective sheeting.

Sign Legend: Black, non-reflective sheeting.

The XX TON BRIDGE WEIGHT LIMIT XX MILES AHEAD sign should be used at such intersecting roads enabling drivers to make detours to avoid a bridge having a restricted weight limit.

Erect the sign at, or no farther than, 25 feet beyond the intersection.

The OTC approved the OR12-6 (XX TON BRIDGE WEIGHT LIMIT XX MILES AHEAD) sign in January 1990. The sign was last updated in December 1997.

# OR12-8

Figure 41: OR12-8 (LENGTH LIMIT) Detail

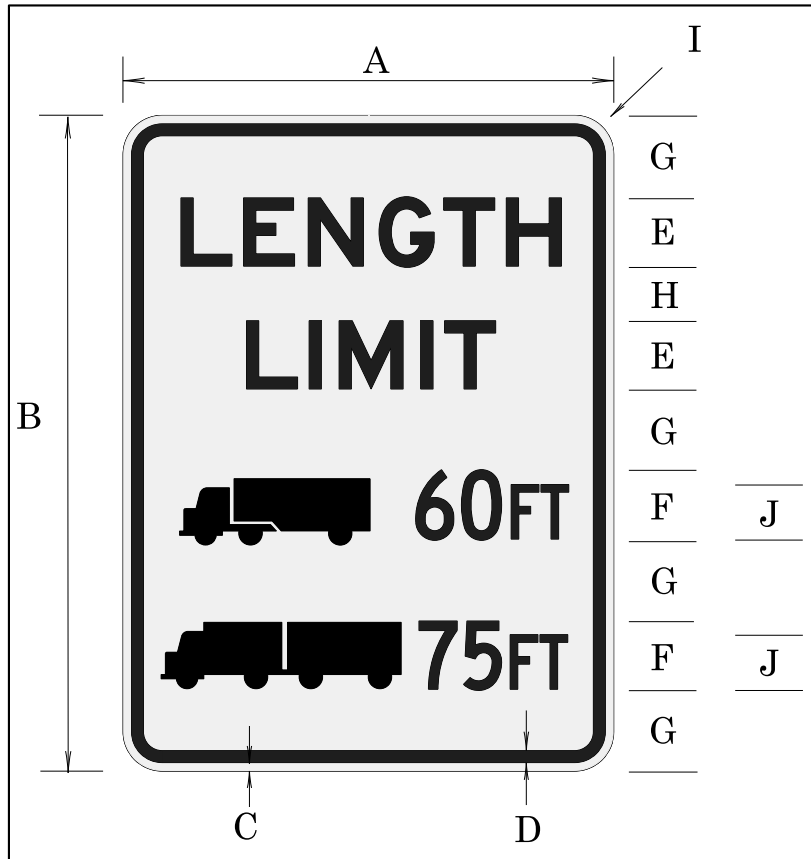

Table 42: OR12-8 (LENGTH LIMIT) Dimensions (inches)

Sign Size	A	B	C	D	E	F	G	H	I	J
Standard	36	48	0.625	0.875	5E	5C	6	4	2.25	4C
Special	48	60	0.75	1.25	6E	6C	7.5	6	3	5C

Sign Background: White, standard retroreflective sheeting.

Sign Legend: Black, non-reflective sheeting.

The LENGTH LIMIT sign may be used to indicate vehicle length restrictions for a section of highway with a length restriction established by a road authority.

The state traffic engineer approved the OR12-8 (LENGTH LIMIT) sign in May 1996. The sign was last updated in May 2009.

# OR14-6

Figure 42: Sign OR14-6 (Motor Carrier Pilot Car Stop) Detail

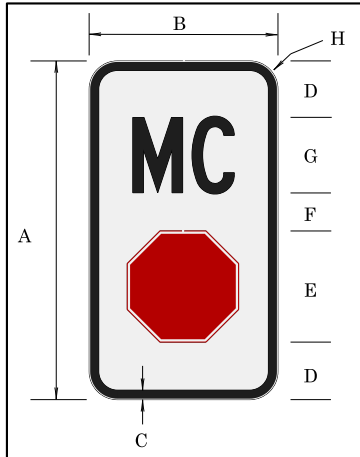

Table 43: Sign OR14-6 (Motor Carrier Pilot Car Stop) Dimensions (inches)

A	B	C	D	E	F	G	H
18	10	0.5	3	6	2	4C	1.5

Sign Background: White, standard retroreflective sheeting.

Sign Legend: Black, non-reflective sheeting; red, standard retroreflective sheeting (STOP sign symbol).

The Motor Carrier Pilot Car Stop marker is used to identify locations that Motor Carrier has designated as places where pilot cars must stop traffic to let wide loads through a section of highway that is too narrow.

The marker shall only be used at sites approved by the Motor Carrier Technical Advisory Committee (MCTAC). Non-ODOT personnel shall submit any additional sites to MCTAC for review and approval prior to installing markers. Region traffic staff will submit any requests for additional sites to Commerce and Compliance Division for them to take to MCTAC.

Region traffic staff is responsible for locating the markers with appropriate sight distance at the locations identified.

The state traffic engineer approved the OR14-6 (Motor Carrier Pilot Car Stop) marker in March 2008.

## CONV. OR15-15A, OR15-15B, OR15-15C, OR15-15D

Figure 43: Signs OR15-15A, OR15-15B, OR15-15C, OR15-15D (Snow Zone Riders) Detail

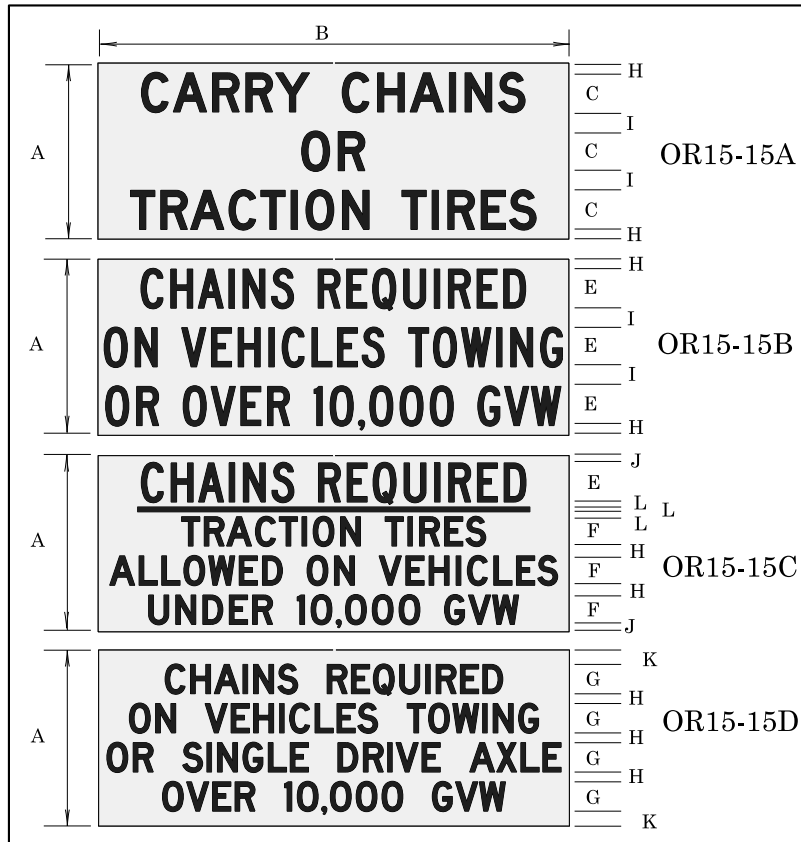

Table 44: Signs OR15-15A, OR15-15B, OR15-15C, OR15-15D (Snow Zone Riders) Dimensions (inches)

A	B	C	E	F	G	H	I	J	K	L
18	48	4D	4C	3D	3D	1	2	0.75	1.5	0.5

Sign Background: White, standard retroreflective sheeting.

Sign Legend: Black, non-reflective sheeting.

Note: Use these interchangeable Snow Zone Riders with the SNOW ZONE (OW15-15) warning sign, for conventional highway application only.

The state traffic engineer approved the OR15-15A, OR15-15B, OR15-15C, OR15-15D (Snow Zone Riders) signs in September 1997. The sign was last updated in January 2014.

# FWY/EXPWY.OR15-15A, OR15-15B, OR15-15C & OR15-15D

Figure 44: Signs OR15-15A, OR15-15B, OR15-15C, OR15-15D (Snow Zone Riders) Detail

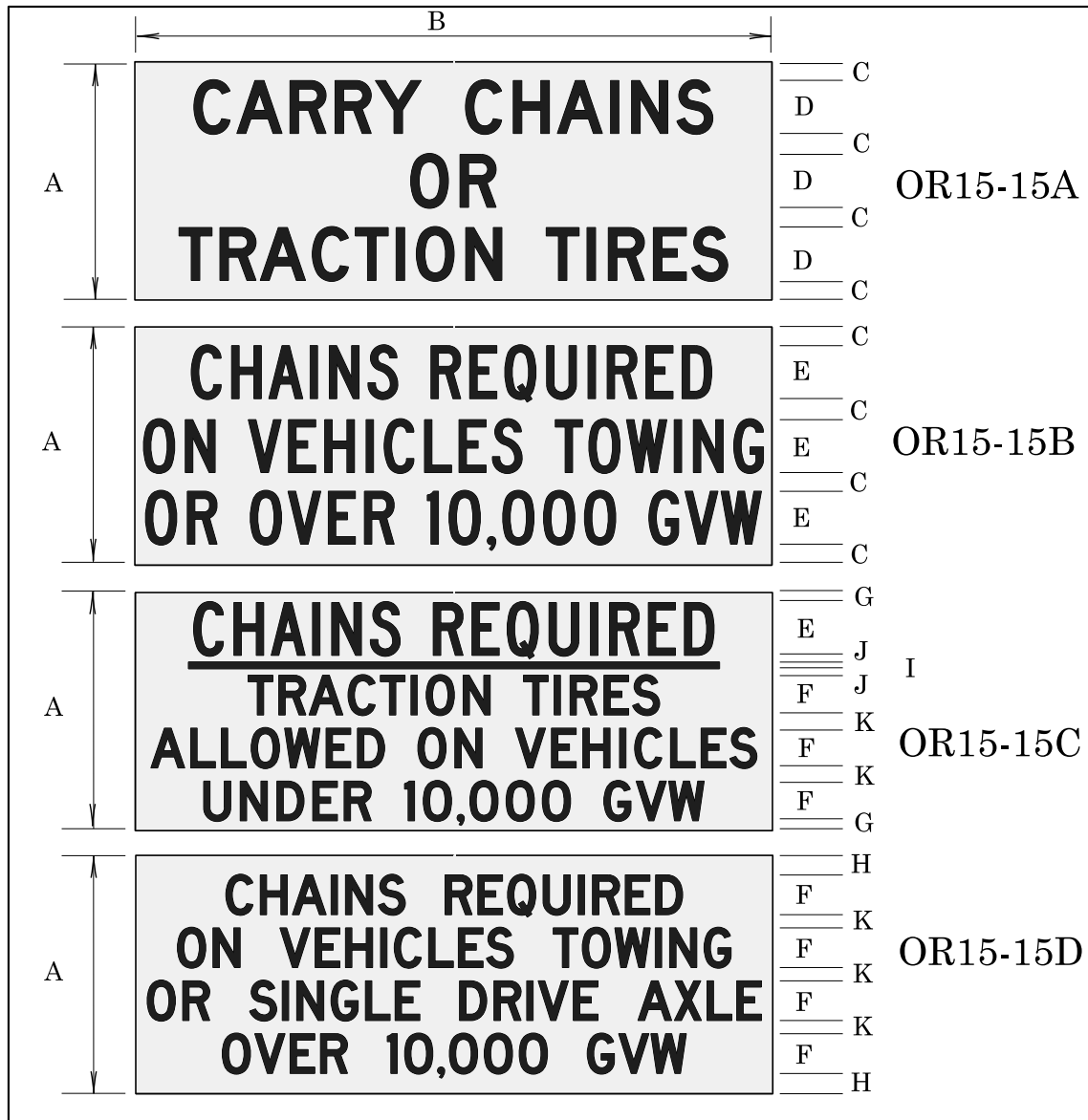

Table 45: Signs OR15-15A, OR15-15B, OR15-15C, OR15-15D (Snow Zone Riders) Dimensions (inches)

A	B	C	D	E	F	G	H	I	J	K
27	66	3	5D	5C	4D	1.5	2.5	0.5	1.25	2

Sign Background: White, standard retroreflective sheeting.

Sign Legend: Black, non-reflective sheeting.

Note: Use these interchangeable Snow Zone Riders with the SNOW ZONE (OW15-15) warning sign, for conventional highway application only.

The state traffic engineer approved the OR15-15A, OR15-15B, OR15-15C, OR15-15D (Snow Zone Riders) signs in January 2014.



# OR16-6

Figure 45: Sign OR16-6 (UNLAWFUL TO THROW AWAY BURNING MATERIAL) Detail



Table 46: Sign OR16-6 (UNLAWFUL TO THROW AWAY BURNING MATERIAL) Dimensions (inches)

A	B	C	D	E	F	G	H
42	30	0.625	0.875	5	4C	3	2.25

Sign Background: White, standard retroreflective sheeting.

Sign Legend: Black, non-reflective sheeting.

The UNLAWFUL TO THROW AWAY BURNING MATERIAL sign may be used at various intervals along any highway where fire hazards are especially prevalent to remind motorists of ORS 476.715. This ORS prohibits throwing away any burning material on any forest land, private road, or public highway within the state.

The OTC approved the OR16-6 (UNLAWFUL TO THROW AWAY BURNING MATERIAL) sign in January 1990. The sign was last updated in December 2011.

# OR17-1

Figure 46: Sign OR17-1 (LEFT TURN YIELD TO ONCOMING TRAFFIC) Detail

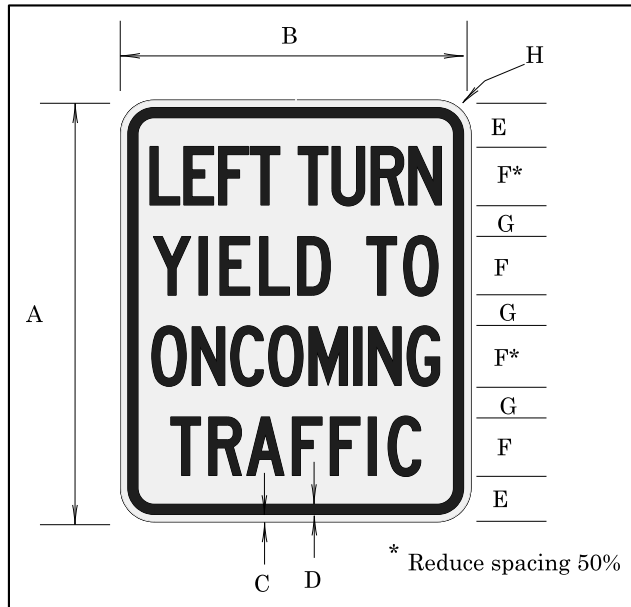

Table 47: Sign OR17-1 (LEFT TURN YIELD TO ONCOMING TRAFFIC) Dimensions (inches)

A	B	C	D	E	F	G	H
36	30	0.625	0.875	4.0625	5C	2.625	2.25

Sign Background: White, standard retroreflective sheeting.

Sign Legend: Black, non-reflective sheeting.

The LEFT TURN YIELD TO ONCOMING TRAFFIC sign may be used at separate left turn lanes or left turn refuge to remind motorists they must yield to oncoming traffic, as per ORS 811.350. Minimum size for standard sign is 30"x36".

Note: R10-12 should be used for signalized intersections.

The OTC approved the OR17-1 (LEFT TURN YIELD TO ONCOMING TRAFFIC) sign in January 1990. The sign was last updated in October 2018.

# OR18-1

Figure 47: Sign OR18-1 (ENTERING WINTER RECREATION AREA PARKING PERMITS REQUIRED BEYOND THIS POINT NOV. 1 TO APRIL 30) Detail

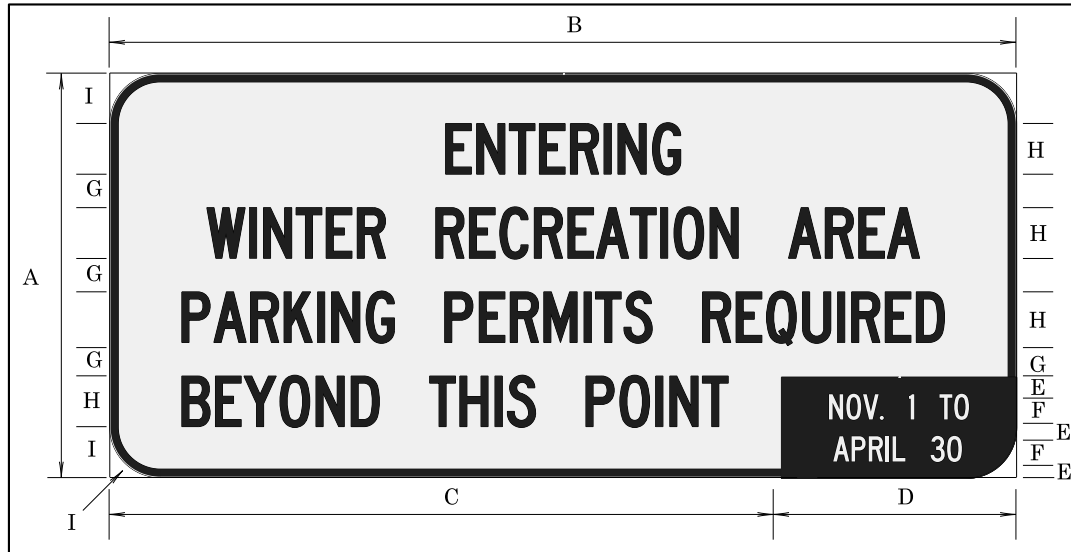

Table 48: Sign OR18-1 (ENTERING WINTER RECREATION AREA PARKING PERMITS REQUIRED BEYOND THIS POINT NOV. 1 TO APRIL 30) Dimensions (inches)

A	B	C	D	E	F	G	H	I
48	108	80	28	2	3C	4	6C	6

Sign Background: White, standard retroreflective sheeting.

Bottom Right Corner: Black, non-reflective sheeting.

Sign Legend: Black, non-reflective sheeting.

Bottom Right Corner: White, standard retroreflective sheeting.

The ENTERING WINTER RECREATION AREA PARKING PERMITS REQUIRED BEYOND THIS POINT NOV. 1 TO APRIL 30 sign shall be installed at the entrance of designated winter recreation parking locations.

A series of five signs (OR18-1, OR18-2, OR18-3, OR18-4, and OD11-1) advise motorists of certain parking restrictions in winter recreation areas, as set forth in ORS 810.170.

The OTC approved the OR18-1 (ENTERING WINTER RECREATION AREA PARKING PERMITS REQUIRED BEYOND THIS POINT NOV. 1 TO APRIL 30) sign in January 1990. The sign was last updated in July 2008.

# OR18-2

Figure 48: Sign OR18-2 (NO PARKING FOR UNATTENDED VEHICLES NOV. 1 TO APRIL 30) Detail



Table 49: Sign OR18-2 (NO PARKING FOR UNATTENDED VEHICLES NOV. 1 TO APR. 30) Dimensions (inches)

A	B	C	D	E	F	G	H	I	J	K	L
48	36	0.875	0.625	3C	4C	5C*	3.75	2.75	4	5.5	2.25

Top Sign Background: White, standard retroreflective sheeting.

Bottom Sign Background: Red, standard retroreflective sheeting.

Top Sign Legend: Red, standard retroreflective sheeting.

Bottom Sign Legend: White, standard retroreflective sheeting.

The NO PARKING FOR UNATTENDED VEHICLES NOV. 1 TO APRIL 30 sign may be installed where leaving an unattended vehicle parked in such a location could create a hazard to highway traffic (such as chain-up pullouts).

A series of five signs (OR18-1, OR18-2, OR18-3, OR18-4, and OD11-1) advise motorists of certain parking restrictions in winter recreation areas, as set forth in ORS 810.170.

The OTC approved the OR18-2 (NO PARKING FOR UNATTENDED VEHICLES NOV. 1 TO APRIL 30) sign in January 1990. The sign was last updated in July 2008.

# OR18-3

Figure 49: Sign OR18-3 (SNO-PARK PARKING PERMITS REQUIRED NOV. 1 TO APRIL 30) Detail



Table 50: Sign OR18-3 (SNO-PARK PARKING PERMITS REQUIRED NOV. 1 TO APRIL 30) Dimensions (inches)

A	B	C	D	E	F	G	H	I	J	K	L	M	N
30	24	0.375	0.625	12	3	2	3D	1.25	1.5C	0.875	2.25	3.25	1.5

Sign Background: White, standard retroreflective sheeting.

Bottom Corner Sign Background: Green, standard retroreflective sheeting.

Sign Legend: Green, standard retroreflective sheeting.

Bottom Corner Sign Legend: White, standard retroreflective sheeting.

The SNO-PARK PARKING PERMITS REQUIRED NOV. 1 TO APRIL 30 sign shall be installed to identify winter recreation parking locations designated under ORS 810.170.

A series of five signs (OR18-1, OR18-2, OR18-3, OR18-4, and OD11-1) advise motorists of certain parking restrictions in winter recreation areas, as set forth in ORS 810.170.

The OTC approved the OR18-3 (SNO-PARK PARKING PERMITS REQUIRED NOV. 1 TO APRIL 30) sign in January 1990. The sign was last updated in July 2008.

# OR18-4

Figure 50: Sign OR18-4 (SNO-PARK PARKING PERMITS REQUIRED "Nov. 1 TO April 30") Detail



Table 51: Sign OR18-4 (SNO-PARK PARKING PERMITS REQUIRED "Nov. 1 TO April 30") Dimensions (inches)

A	B	C	D	E	F	G	H	I	J	K	L	M	N	O
30	24	12	0.375	0.625	3	3	2	3D	1.25	1.5C	0.875	2.25	3.25	1.5

Top Sign Background: White, standard retroreflective sheeting.

Bottom Corner Sign Background green, standard retroreflective sheeting.

Top Sign Legend: Green, standard retroreflective sheeting.

Bottom Corner Sign Legend: White, standard retroreflective sheeting.

The SNO-PARK PARKING PERMITS REQUIRED "Nov. 1 TO April 30" sign shall be installed to identify winter recreation parking locations designated under ORS 810.170.

A series of five signs (OR18-1, OR18-2, OR18-3, OR18-4, and OD11-1) advise motorists of certain parking restrictions in winter recreation areas, as set forth in ORS 810.170.

The OTC approved the OR18-4 (SNO-PARK PARKING PERMITS REQUIRED) sign in January 1992. The sign was last updated in July 2008.

# OR20-1

Figure 51: Sign OR20-1 (ONE VEHICLE PER GREEN) Detail

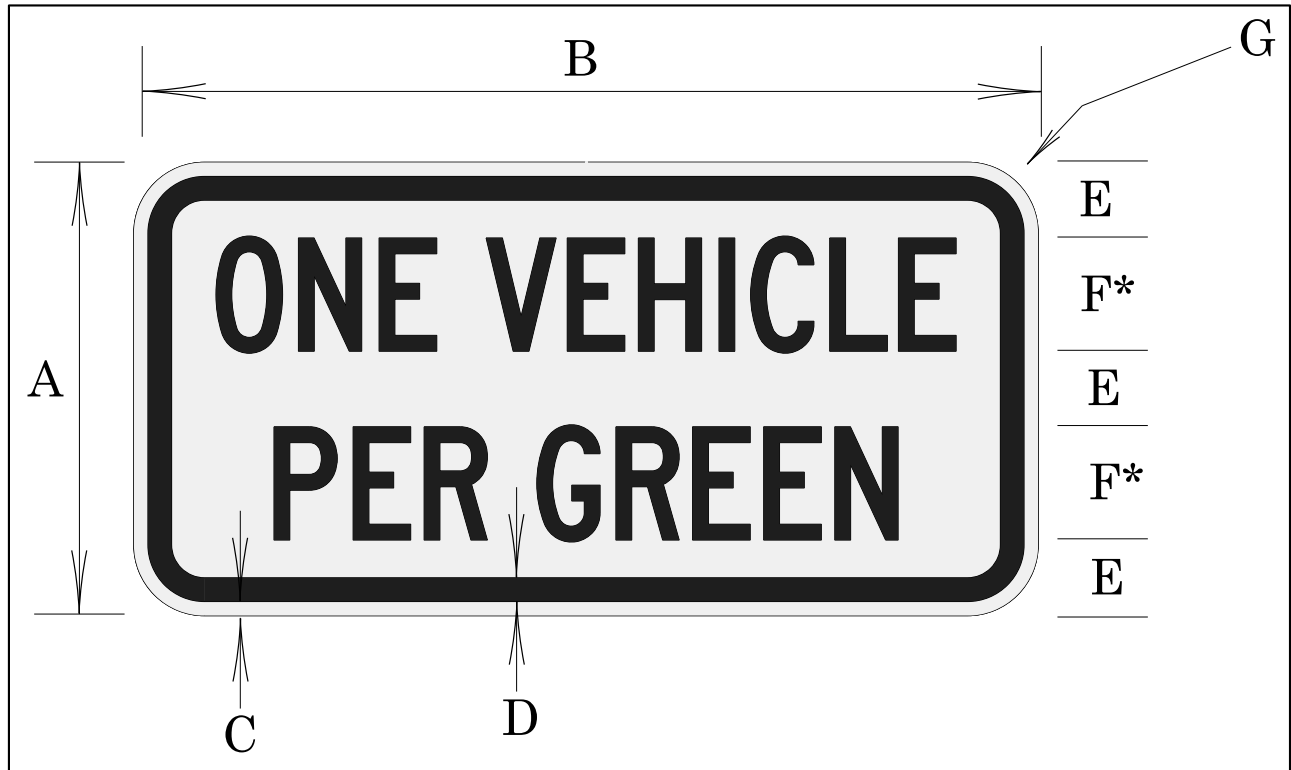

Table 52: Sign OR20-1 (ONE VEHICLE PER GREEN) Dimensions (inches)

A	B	C	D	E	F	G
12	24	0.375	0.625	2	3C	1.5

\*Letter spacing reduced 30%

Sign Background: White, standard retroreflective sheeting.

Sign Legend: Black, non-reflective sheeting.

The ONE VEHICLE PER GREEN sign shall be used in conjunction with the ramp signal installation, and mount below the two-section signal head. The sign informs motorists that one – and only one – vehicle may enter the freeway on each green indication.

The OTC approved the OR20-1 (ONE VEHICLE PER GREEN) sign in January 1990. The sign was last updated in December 1997.

# OR20-5

Figure 52: Sign OR20-5 (FORM 2 LANES WHEN METERED) Detail

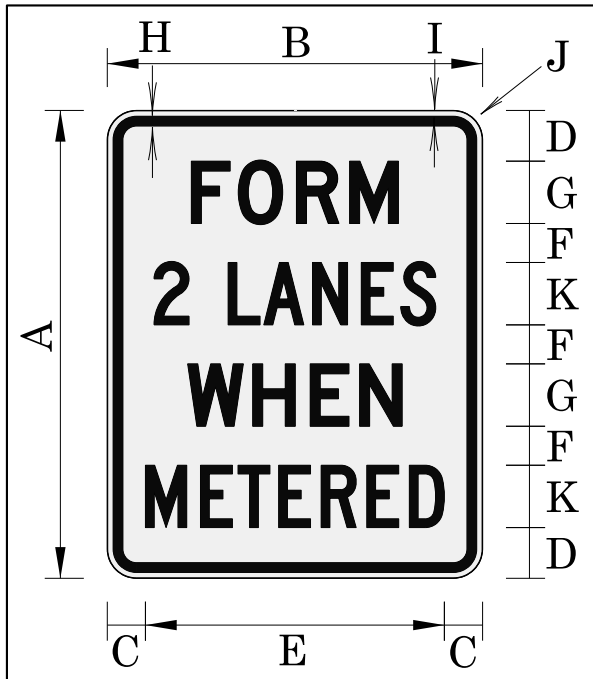

Table 53: Sign OR20-5 (FORM 2 LANES WHEN METERED) Dimensions (inches)

A	B	C	D	E	F	G	H	I	J	K
30	24	2.45	3.25	19.1	2.5	4D	0.625	0.375	1.5	4C

Sign Background: White, standard retroreflective sheeting.

Sign Legend: Black, non-reflective sheeting.

The FORM 2 LANES WHEN METERED sign shall be used in conjunction with the ramp signal installation. Use this sign to convert the single lane on-ramp into a dual-lane queue storage reservoir during ramp signal operations. Position it near the beginning of the dual-lane queue storage reservoir on the right side of the on-ramp (or positioned on both sides of the ramp).

The state traffic engineer approved the OR20-5 (FORM 2 LANES WHEN METERED) sign in July 2013.



# OR21-1

Figure 53: Sign OR21-1 (NO FISHING FROM BRIDGE) Detail

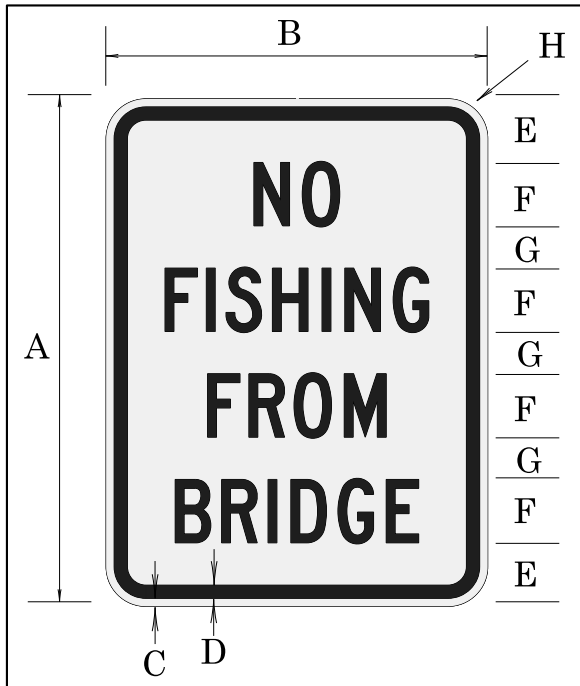

Table 54: Sign OR21-1 (NO FISHING FROM BRIDGE) Dimensions (inches)

A	B	C	D	E	F	G	H
24	18	0.375	0.625	3	3C	2	1.5

Sign Background: White, standard retroreflective sheeting.

Sign Legend: Black, non-reflective sheeting.

The NO FISHING FROM BRIDGE sign should be used to inform the public the governing authority has prohibited fishing from the structure.

The OTC approved the OR21-1 (NO FISHING FROM BRIDGE) sign in June 1990. The sign was last updated in December 1997.

## OR21-2a

Figure 54: Sign OR21-2a (DIVING OR JUMPING FROM BRIDGE PROHIBITED) Detail

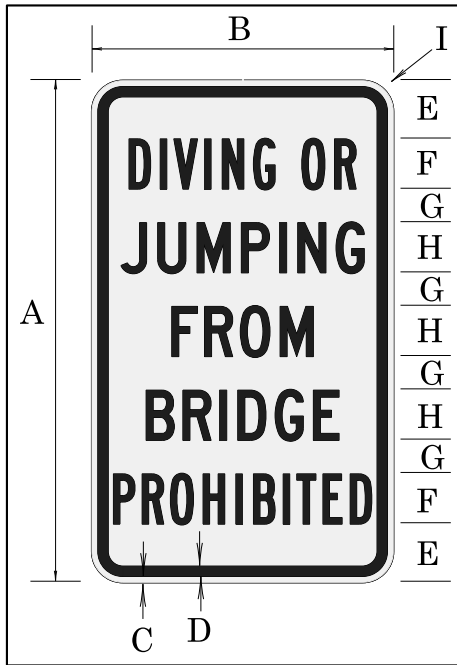

Table 55: Sign OR21-2a (DIVING OR JUMPING FROM BRIDGE PROHIBITED) Dimensions (inches)

A	B	C	D	E	F	G	H	I
30	18	0.375	0.625	3.5	3B	2	3C	1.5

Sign Background: White, standard retroreflective sheeting.

Sign Legend: Black, non-reflective sheeting.

The DIVING OR JUMPING FROM BRIDGE PROHIBITED sign should be used to inform the public the governing authority has prohibited diving from the structure.

The OTC approved the OR21-2a (DIVING OR JUMPING FROM BRIDGE PROHIBITED) sign in January 1992. The sign was last updated in December 1997.

## OR21-3a

Figure 55: Sign OR21-3a (DON'T LITTER MAX FINE \$6250) Detail



Table 56: Sign OR21-3a (DON'T LITTER MAX FINE \$6250) Dimensions (inches)

Sign Size	A	B	C	D	E	F	G	H	J	K	L	M
Standard	48	36	0.625	0.875	2.25	7.5	6C	6	5	4C	4	5.5
Freeway	60	48	0.75	1.25	3	8.5	8C	6.5	5.5	6C	4.5	7

Sign Background: White, standard retroreflective sheeting.

Sign Legend: Black, non-reflective sheeting.

The DON'T LITTER MAX FINE \$6250 sign may be used to inform motorists of Oregon statutes and potential fines incurred under ORS 164.805, ORS 164.785, and ORS 476.715.

The state traffic engineer approved OR21-3a (DON'T LITTER MAX FINE \$6250) sign in September 2006.

# OR21-4a

Figure 56: Sign OR21-4a (MOBILE DEVICE USE PROHIBITED WHILE DRIVING) Detail



Table 57: Sign OR21-4a (MOBILE DEVICE USE PROHIBITED WHILE DRIVING) Dimensions (inches)

Sign Size	A	B	C	D	E	F	G	H	J	K	L	M	N
Minimum	48	36	0.625	0.875	2.25	4B	4C	4.75	3.5	2.125	1.5	4.5*	3.75
Standard	72	48	0.75	1.25	3	6B	6C	6	4	2.75	1.5	6.5*	4.5
Freeway	96	72	0.75	1.25	3	8B	8C	9.5	7	4.75	3	8*	7.5

\*Measured from edge of sign to edge of bar

The MOBILE DEVICE USE PROHIBITED WHILE DRIVING sign should be placed at all entrances to the state. Leave the signs in place for approximately five years from first date of installation. They need not be replaced once they've reached their useful service life.

The signs may be placed on highways anywhere in the state to remind motorists the hand-held cellphone law is in effect. This sign is in support of ORS 811.507.

The state traffic engineer approved OR21-4a (MOBILE DEVICE USE PROHIBITED WHILE DRIVING) sign was approved in October 2017.

# OR22-1

Figure 57: Sign OR22-1 (MOTORCYCLISTS STATE LAW REQUIRES USE OF LIGHTS AT ALL TIMES) Detail

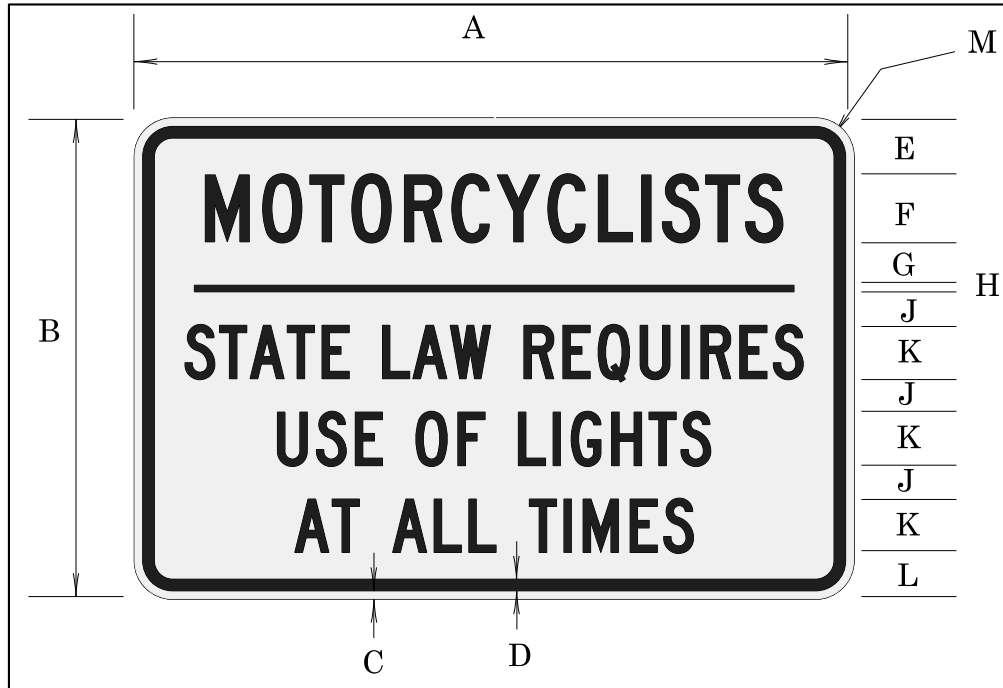

Table 58: Sign OR22-1 (MOTORCYCLISTS STATE LAW REQUIRES USE OF LIGHTS AT ALL TIMES) Dimensions (inches)

Sign Size	A	B	C	D	E	F	G	H	J	K	L	M
Standard	18	12	0.375	0.625	2	1.5C	1	0.25	0.75	1C	2	1.5
Freeway	54	36	0.625	0.875	4.25	5C	3.25	0.5	2.5	4C	3.5	2.25

Sign Background: White, standard retroreflective sheeting.

Sign Legend: Black, non-reflective sheeting.

The MOTORCYCLISTS STATE LAW REQUIRES USE OF LIGHTS AT ALL TIMES sign may be placed on state highways close to the borders to inform motorcyclists of state law per ORS 814.320.

The OTC approved the OR22-1 (MOTORCYCLISTS STATE LAW REQUIRES USE OF LIGHTS AT ALL TIMES) sign in June 1990. The sign was last updated in December 1997.

# OR22-2

Figure 58: Sign OR22-2 (HELMETS REQUIRED) Detail

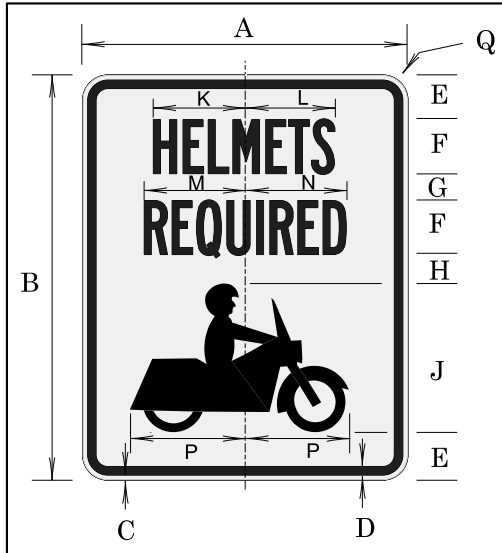

Table 59: Sign OR22-2 (HELMETS REQUIRED) Dimensions (inches)

Sign Size	A	B	C	D	E	F	G
Min. & Std.	24	30	0.375	0.625	3.25	4B	2
Expressway	36	48	0.625	0.875	5.5	6C	4.25
Freeway	48	60	0.75	1.25	6.25	8C	4.5

Sign Size	H	J	K	L	M	N	P	Q
Min. & Std.	2	11.5	7.5	7.5	8.5	8.5	8.25	1.5
Expressway	3.5	17.25	14.375	14.3125	15.875	15.875	12.375	2.25
Freeway	4	23	19.125	19.125	21.1875	21.125	16.5	3

Sign Background: White, standard retroreflective sheeting.

Sign Legend: Black, non-reflective sheeting.

The HELMETS REQUIRED symbol sign may be placed on state highways close to the borders to inform motorcyclists of state law per ORS 814.269.

The OTC approved the OR22-2 (HELMETS REQUIRED) sign in June 1990. The sign was last updated in December 1997.

# OR22-3

Figure 59: Sign OR22-3 (SAFETY BELTS IT'S THE LAW) Detail



Table 60: Sign OR22-3 (SAFETY BELTS IT'S THE LAW) Dimensions (inches)

Sign Size	A	B	C	D	E	F	G	H	J	K
Minimum	30	42	4C*	0.5	0.75	2.75	1.5	1.875	20	15
Standard	36	48	5C*	0.625	0.875	3.5	2	2.25	20	15
Freeway	48	60	6C	0.75	1.25	5	4	3	20	15

\*Reduce all spacing 25% on bottom line of legend

Sign Background: White, standard retroreflective sheeting.

Sign Legend: Black, non-reflective sheeting.

The SAFETY BELTS (symbol) IT'S THE LAW sign should be placed at all entrances to the state. Leave the signs in place for approximately five years from first date of installation. After that, they need not be replaced.

The SAFETY BELTS (symbol) IT'S THE LAW signs may be placed on highways anywhere in the state to remind motorists the seat belt law is in effect. This is in support of ORS 811.210.

The OTC approved the OR22-3 (SAFETY BELTS IT'S THE LAW) sign in January 1992. The sign was last updated in December 1997.

## OR22-4

Figure 60: Sign OR22-4 (ALL TRUCKS, OVER 20,000 GVW RIGHT) Detail

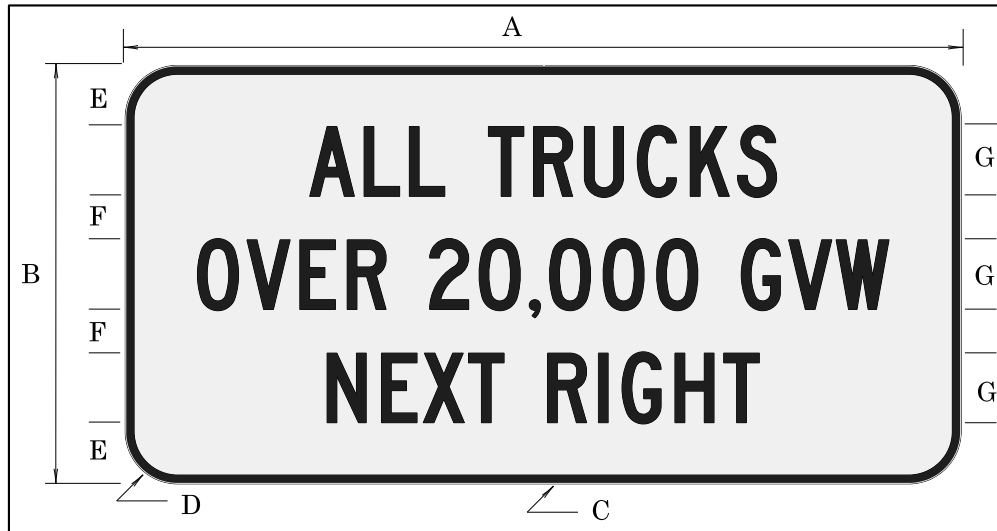

Table 61: Sign OR22-4 (ALL TRUCKS, OVER 20,000 GVW RIGHT) Dimensions (inches)

Sign Size	A	B	C	D	E	F	G
Standard	96	48	1	6	7	5	8C
Freeway/Expressway	144	54	1	6	8	7	8EM

Sign Background: White, standard retroreflective sheeting.

Sign Legend: Black, non-reflective sheeting.

The ALL TRUCKS, OVER 20,000 GVW NEXT RIGHT sign should be located after the initial weigh station advance sign. This sign allows vehicles less than 20,000 GVW to bypass the weigh station.

If appropriate, crews may replace the "NEXT RIGHT" sign with "MUST EXIT."

The OTC approved the OR22-4 (ALL TRUCKS, OVER 20,000 GVW NEXT RIGHT) sign in July 1999. The sign was last updated in February 2006.



## OR22-6

Figure 61: Sign OR22-6 (YIELD TO ONCOMING TRAFFIC) Detail

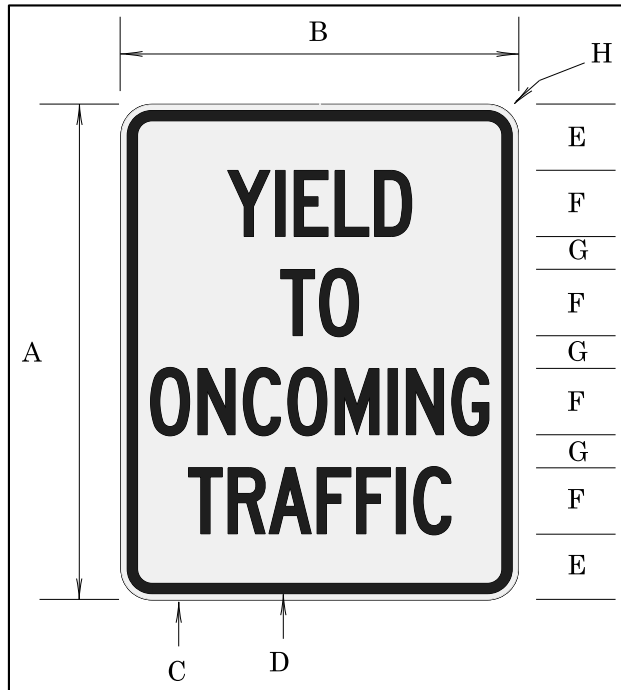

Table 62: Sign OR22-6 (YIELD TO ONCOMING TRAFFIC) Dimensions (inches)

A	B	C	D	E	F	G	H
30	24	0.375	0.625	4	4C	2	1.5

Sign Background: White, standard retroreflective sheeting.

Sign Legend: Black, non-reflective sheeting.

The YIELD TO ONCOMING TRAFFIC sign should be used at some intersections if an engineering investigation shows a need for this legend.

The OTC approved the OR22-6 (YIELD TO ONCOMING TRAFFIC) sign in January 1992. The sign was last updated in October 2018.

# OR22-7

Figure 62: Sign OR22-7 (CROSSWALK CLOSED) Detail

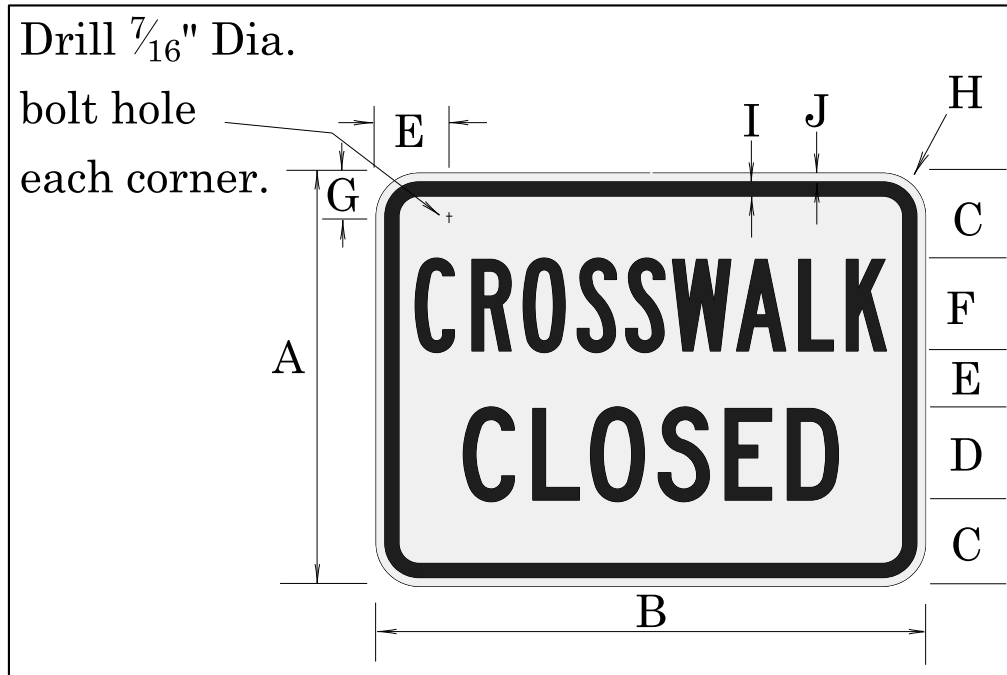

Table 63: Sign OR22-7 (CROSSWALK CLOSED) Dimensions (inches)

A	B	C	D	E	F	G	H	I	J
18	24	3.75	4C	2.5	4B	1.25	1.5	0.625	0.375

Sign Background: White, standard retroreflective sheeting.

Sign Legend: Black, non-reflective sheeting.

The CROSSWALK CLOSED sign should be used to inform pedestrians that a crosswalk is closed. The sign is normally mounted on a crosswalk closure barricade behind the face of curb.

Note: The state traffic engineer must approve a crosswalk closure before crews use this sign on state highways. See Traffic Manual for more info.

The OTC approved the OR22-7 (CROSSWALK CLOSED) sign in January 1992. The sign was last updated in October 2018.

# OR22-9

Figure 63: Sign OR22-9 (DO NOT PASS SNOWPLOWS ON THE RIGHT) Detail

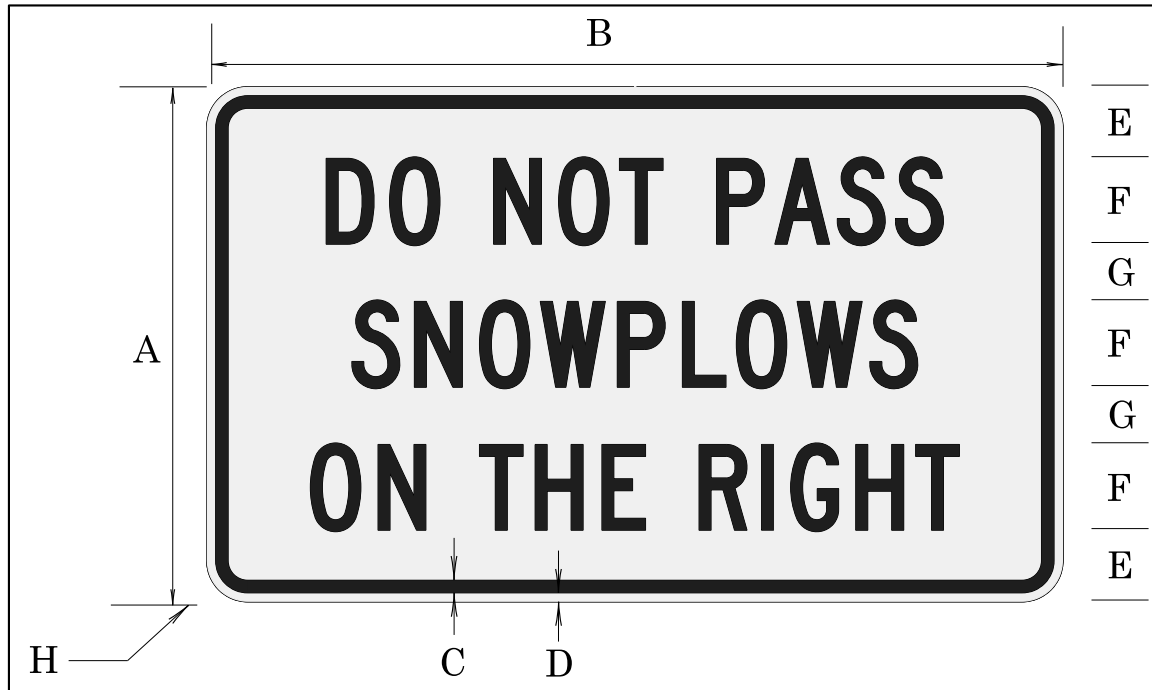

Table 64: Sign OR22-9 (DO NOT PASS SNOWPLOWS ON THE RIGHT) Dimensions (inches)

A	B	C	D	E	F	G	H
36	60	0.875	0.625	5	6C	4	2.25

Sign Background: White, standard retroreflective sheeting.

Sign Legend: Black, non-reflective sheeting.

The DO NOT PASS SNOWPLOWS ON THE RIGHT sign may be used in multi-lane locations to instruct motorists not to pass snowplows on the right side.

The OTC approved the OR22-9 (NO NOT PASS SNOWPLOWS ON THE RIGHT) sign in January 1992. The sign was last updated in December 1997.

# OR22-10

Figure 64: Sign OR22-10 (STATE LAW-UNMUFFLED ENGINE BRAKING PROHIBITED) Detail

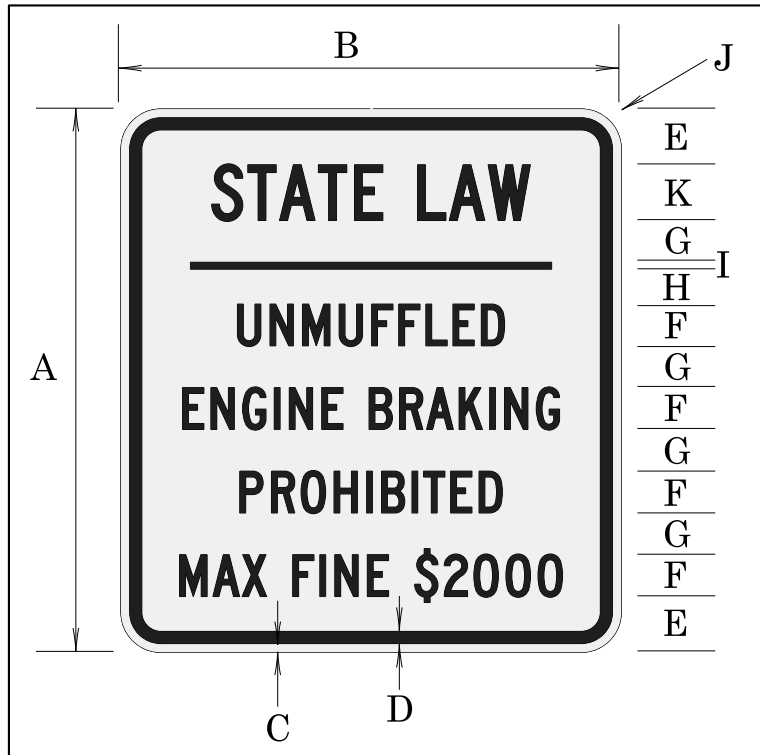

Table 65: Sign OR22-10 (STATE LAW-UNMUFFLED ENGINE BRAKING PROHIBITED) Dimensions (inches)

A	B	C	D	E	F	G	H	I	J	K
39	36	0.625	0.875	4	3C	3	2.5	0.5	2.25	4C

Sign Background: White, standard retroreflective sheeting.

Sign Legend: Black, non-reflective sheeting.

The intended placement of the STATE LAW-UNMUFFLED ENGINE BRAKING PROHIBITED sign is in the port of entries. On those highways without a port of entry, place the sign near the state border where space permits in support of ORS 811.492 and 810.214.

The state traffic engineer approved the OR22-10 (STATE LAW-UNMUFFLED ENGINE BRAKING PROHIBITED) sign in March 1994. The sign was last updated in August 2011.

# OR22-11

Figure 65: Sign OR22-11 (UNMUFFLED ENGINE BRAKING PROHIBITED) Detail

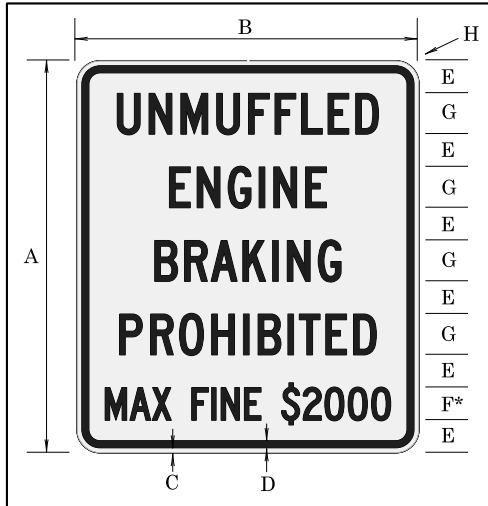

Table 66: Sign OR22-11 (UNMUFFLED ENGINE BRAKING PROHIBITED) Dimensions (inches)

A	B	C	D	E	F*	G	H
48	42	0.625	0.875	4	4C	5C	2.25

\*Letter spacing reduced by 30%

Sign Background: White, standard retroreflective sheeting.

Sign Legend: Black, non-reflective sheeting.

The UNMUFFLED ENGINE BRAKING PROHIBITED sign may be used to remind drivers of the provisions listed in ORS 811.492 and 810.214.

This sign can be installed in specified locations if it meets the following warrants:

1. The area has an established record of unmuffled engine brake noise complaints (minimum of six different people complaining about four different incidents) supported by an engineering investigation.
2. Signed concurrence from the law enforcement agency in the jurisdiction that the sign falls within acknowledging an action plan to enforce the law.
3. Approval of state traffic engineer.

Jurisdictions other than ODOT may use their own criteria to determine the location of this sign.

The state traffic engineer approved the OR22-11 (UNMUFFLED ENGINE BRAKING PROHIBITED) sign in August 1995. The sign was last updated in August 2011.

## OR22-16 & OR22-17

Figure 66: Sign OR22-16 & OR22-17 (NO LANE CHANGES NEXT XXXX FT) Detail

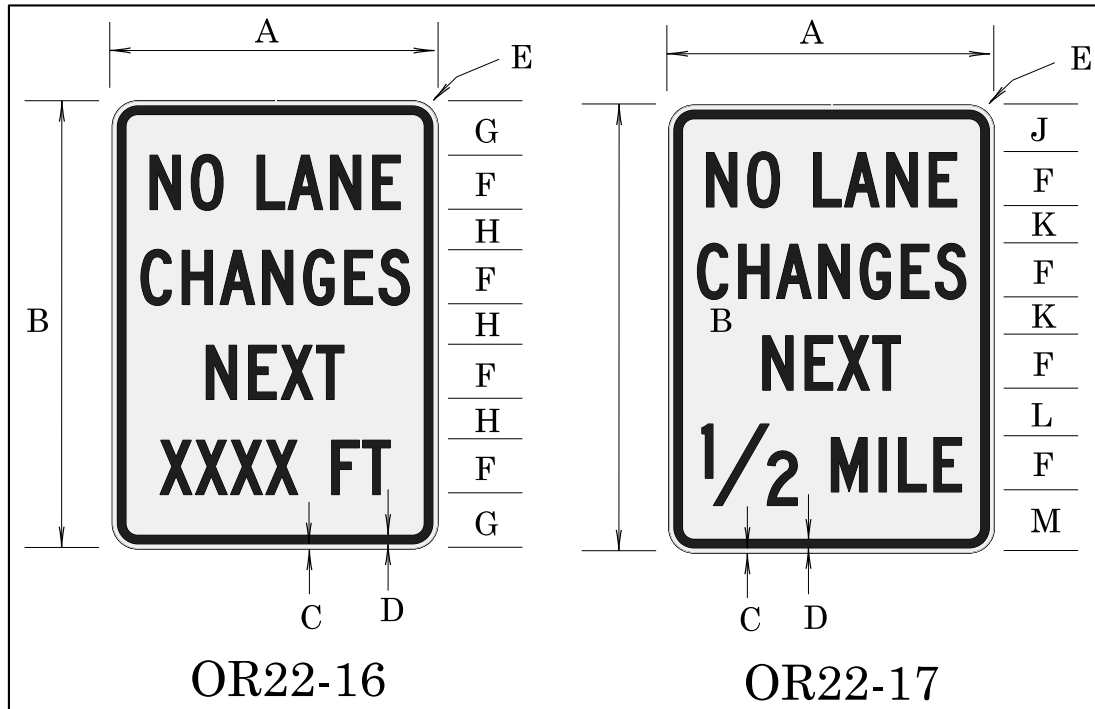

Table 67: Sign OR22-16 & OR22-17 (NO LANE CHANGES NEXT XXXX FT) Dimensions (inches)

Sign Size	A	B	C	D	E	F	G	H	J	K	L	M
Standard	36	48	0.625	0.875	2.25	6C	6	4	5	3.5	5	7
Freeway	48	66	0.75	1.25	3	8C	8	6	7	5.5	7	9

Sign Background: White, standard retroreflective sheeting.

Sign Legend: Black, non-reflective sheeting.

Use the NO LANE CHANGES NEXT XXXX FT (OR22-16) sign to direct motorists to not change lanes for a distance specified in feet. Use the NO LANE CHANGES NEXT X/X MILE (OR22-17) sign to direct motorists to not change lanes for a distance specified in 1/4 mile increments.

Use solid white lane lines from this sign to end of restriction.

The state traffic engineer approved the OR22-16 & OR22-17 (NO LANE CHANGES NEXT XXXX FT) sign in March 1998. The sign was last updated in May 2007.

# OR22-18

Figure 67: Sign OR22-18 (RAMP CLOSED) Detail

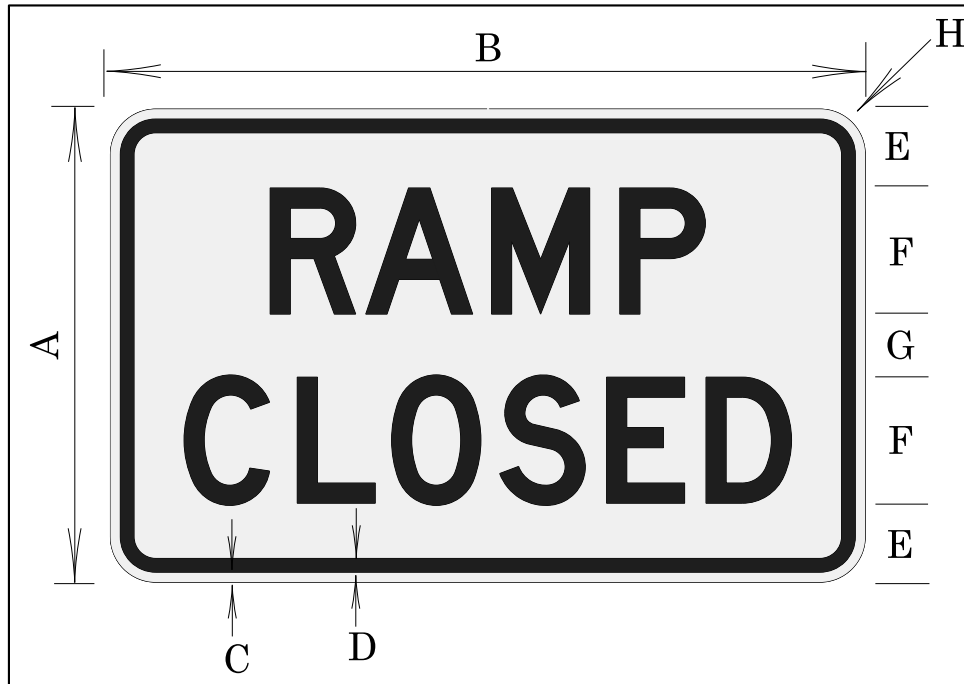

Table 68: Sign OR22-18 (RAMP CLOSED) Dimensions (inches)

A	B	C	D	E	F	G	H
30	48	0.625	0.875	5	8D	4	2.25

Sign Background: White, standard retroreflective sheeting.

Sign Legend: Black, non-reflective sheeting.

The RAMP CLOSED sign should be used when construction or maintenance activities have closed the ramp. This sign may also be used for incident management if available.

The state traffic engineer approved the OR22-18 (RAMP CLOSED) sign in January 2000.

# OR22-19

Please note: Do not use sign OR22-19 on state highways.

Figure 68: Sign OR22-19 (ODOT PERSONNEL ONLY MAX LOADING XXX LBS) Detail

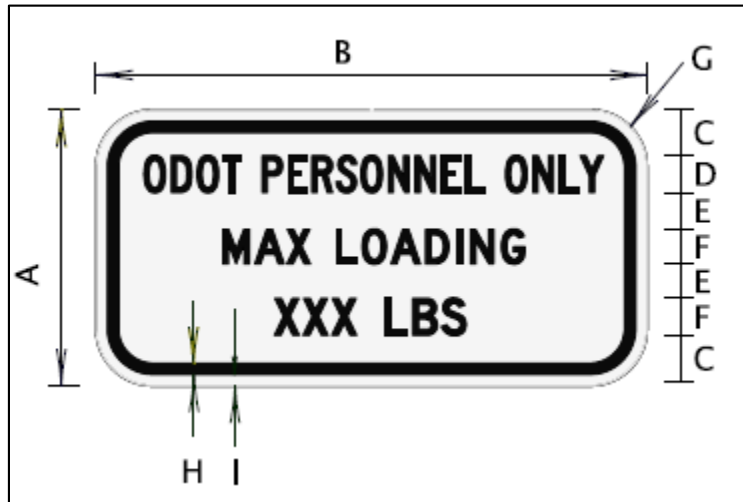

Table 69: Sign OR22-19 (RAMP CLOSED) Dimensions (inches)

A	B	C	D	E	F	G	H	I
6	12	1	0.8C	0.8	0.8D	1	0.25	0.25

Sign Background: White, standard retroreflective sheeting.

Sign Legend: Black, non-reflective sheeting.

The ODOT PERSONNEL ONLY MAX LOADING XXX LBS sign shall be used to display weight limits on pedestrian walkways that service VMS signs. Do not use these signs on the state highway system if visible to motorists.

The state traffic engineer approved the OR22-19 (ODOT PERSONNEL ONLY MAX LOADING XXX LBS) sign in May 2021.



# OR22-20

Figure 69: Sign OR22-20 (NO ATVs symbol sign) Detail

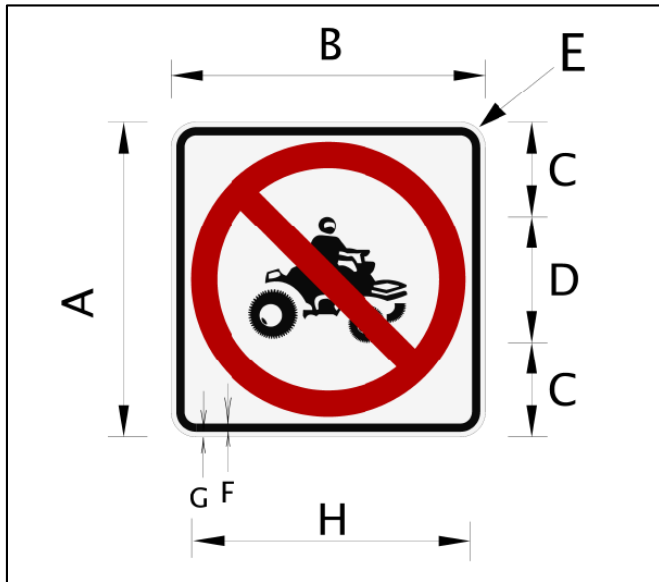

Table 70: Sign OR22-20 (NO ATVs symbol signs) Dimensions (inches)

A	B	C	D	E	F	G	H
30	30	9	12	1.88	0.75	0.5	26.23

Sign Background: White, standard retroreflective sheeting.

Sign Legend: Black, non-reflective sheeting.

The No ATVs symbol sign may be used to denote the end of an ATV route that coincides with the highway on an approved ATV Highway Access Route.

The state traffic engineer approved the OR22-20 (No ATV symbol) sign in February 2018.

## **Chapter 4: Warning Signs**

### **Design of Warning Signs (MUTCD 2C.03)**

Use engineering judgment in the selection and installation of different sizes of standard or special warning signs. Normally, all new installations of warning signs on the state highway system will be 36" or larger.

### **Placement of Warning Signs (MUTCD 2C.05)**

MUTCD Table 2C-4 lists suggested sign placement distances for two conditions. This table is provided as an aid for determining warning sign locations.

The critical factor in warning sign placement is visibility, adequate warning to the driver so they can react to the situation and use of the proper warning sign. Different situations will require warning sign placement that does not comply with the suggested placement distances set forth in Table 2C-4. The table was designed using 30" warning signs; if the road agency uses larger signs, the distance listed can be reduced. The use of high performance sheeting on signs also allows different sign placement distances.

Table 2C-4 was designed for a single warning placement. When the road authority uses two or more warning signs for the same condition in sequence, the table is no longer valid. Use of other warning devices plays an important role in relaying the warning to the driver; such as adding chevrons to a curve.

### **Horizontal Alignment Warning Signs (MUTCD 2C.06)**

The approach speed, in the parallel deceleration lane as it approaches the exit ramp curve, should be used rather than the speed of the mainline freeway lanes, when applying MUTCD Table 2C-5 to exit ramps.

### **Horizontal Alignment Signs (W1-1 through W1-5, W1-11, W1-15) (MUTCD 2C.07)**

All turn, curve, reverse turn, and reverse curve signs shall have an advisory speed plate when the comfortable safe speed on the curve is 10 mph or more below the posted speed.

### **Advisory Speed Plaque (W13-1P) (MUTCD 2C.08)**

Ball-bank indication is our adopted standard practice for determining appropriate posting of advisory speeds in the state of Oregon. Criteria and appropriate values for ball-bank indication

are as spelled out in the MUTCD. Use of ball-bank indication for determining safe speed on curves is the responsibility of each region's traffic engineering staff. Follow Traffic-Roadway Section technical bulletin [TR15-01\(B\)](#).

### **Speed Hump Sign (W17-1) (MUTCD 2C.29)**

Speed hump signs or markings shall be placed on a public roadway to identify its location. When placing several speed humps in a series along a roadway between intersections, crews may post a single SPEED HUMP sign with a rider indicating the series of humps ahead for the series.

### **Lane Ends Signs (W4-2, W9-1, W9-2) (MUTCD 2C.42)**

The Lane Ends symbol sign (W4-2) shall be used in advance of a lane drop. The RIGHT (LEFT) LANE ENDS sign (W9-1) may be used in advance of the Lane Ends sign. Do not use the LANE ENDS MERGE LEFT (RIGHT) sign (W9-2) under normal conditions.

### **Intersection Warning Signs (W2-1 through W2-8) (MUTCD 2C.46)**

When approaching an intersection, guide signs or warning signs may be used on state highways. It is important to take into consideration the purpose of the sign when deciding to install a sign. The first principal would be the need of the road user, which may be guidance or warning depending on the intersection. For intersection warning signs consider installing them if the following is present:

- Insufficient sight distance (see design manual) for the vehicles entering traffic to see oncoming vehicles or for mainline vehicles to see vehicles entering from a side street.
- Back-up of turn queues into the mainline through traffic.
- History of crashes from cars entering the mainline or exiting the mainline in regards to the side street.

Intersection warning signs may not be needed if<sup>1</sup>:

- Channelization for turns is present, including a two-way left turn lane.
- The intersection is signalized or all way stop or yield controlled.

---

<sup>1</sup> If any of the above are present, but the cross street has significant traffic, consider installing an advanced street name guide sign for the intersection. Also see MUTCD 2D.44 for more information on advanced street name signs.

- Urbanized location where entering and exiting traffic is already expected.

### **Intersection Warning Signs- Roundabouts (W2-6 and W16-12P) (MUTCD 2C.46)**

The educational TRAFFIC CIRCLE plaque (W16-12p) shall not be used with the Circular Intersection symbol sign (W2-6).

The Circular Intersection symbol sign (W2-6) shall be used in advance of a roundabout intersection to inform motorists they are approaching the roundabout. The sign is usually accompanied by an appropriate speed rider.

### **Non-vehicular Warning Signs (W11-2, W11-3, W11-4, W11-6, W11-7, W11-9, and W11-16 through W11-22) (MUTCD 2C.50)**

The Snowmobile Crossing symbol sign (W11-6) may be used on state highways under the following conditions:

1. The operator or owner of the snowmobile trail shall install STOP signs on the trail, outside the highway right-of-way.
2. Locate the crossing, as nearly as possible, at 90 degrees to the highway.
3. The region traffic office will conduct a traffic investigation of the proposed crossing to insure the safety of the crossing.
4. ODOT shall make initial installation of snowmobile crossing signs.

ODOT policy is to reserve the use of fluorescent yellow-green sign sheeting for school zone signing on state highways including the "SCHOOL" portion of the SCHOOL SPEED LIMIT (S5-1) sign and any supplemental plaques used in association with these warning signs. Pedestrian and/or bicycle warning signs should use the standard yellow color. Fluorescent yellow sign sheeting may be used for pedestrian and/or bicycle crossing signs if there is a need to call extra attention to a particular crossing.

The region traffic engineer may allow the use of fluorescent yellow-green for pedestrian/bicycle warning signs on a state highway if the requesting jurisdiction can demonstrate an existing systematic approach to pedestrian signing which includes the fluorescent yellow-green sign background. However, other treatments must be considered before choosing fluorescent yellow-green sign sheeting (e.g. curb extensions, pedestrian refuge islands, rapid flash beacons, etc.). The mixing of standard yellow and fluorescent yellow-green backgrounds for pedestrian/bicycle signs within a selected site area should be avoided.

## **Use of Supplemental Warning Plaques (MUTCD 2C.53)**

The Distance Ahead Plaques (W16-2 and W16-3 Series) or the AHEAD Plaque (W16-9p) may accompany any of the Vehicular Traffic Signs or Non-vehicular Signs (W11 Series) as secondary riders for installations used in advance of an actual crossing area, marked or unmarked. On the State Highway System, the AHEAD Plaque (W16-9p) is the preferred rider.

## **Policy for the use of Sign Flag Boards (Yellow or Orange Diamonds)**

Overuse or misuse of warning signs and devices erodes the effectiveness of their future use as safety devices. MUTCD Table 2A-5 reserves the use of orange. Therefore, ODOT's policy requires orange flag boards be reserved for construction and maintenance only. For all other uses, as described below, sign flag boards shall have fluorescent yellow wide-angle prismatic sheeting.

Standards for the actual design and placement of the sign flag boards are found on Oregon Standard Drawing TM 204.

Criteria for the application and use of fluorescent yellow wide-angle prismatic flag boards are as follows:

- For changes in regulatory conditions. Examples include intersection control, lane use, and speed zone changes. Sign flag boards may be used either in conjunction with sign W23-2 ("NEW TRAFFIC PATTERN AHEAD") or to draw attention to permanent warning signs or regulatory signs. Sign flag boards (as well as sign W23-2) generally should be in place approximately one month.
- On interstate or other freeways at reductions in speed zones where the change is 10 mph or greater. This does not apply to school speed zone signing. Do not use sign flag boards in conjunction with school speed zone signing unless part of bullet one above.
- Safety corridors. ODOT Sign Design Manual includes a layout drawing illustrating the usage of sign flag boards in a safety corridor. The usage is optional, but if chosen, all appropriate signs in the safety corridor should include the sign flag boards. In addition to the signs identified in the layout drawing, sign flag boards may be added to warning or regulatory signs within the safety corridor. Region traffic managers must approve the use of sign flag boards.
- As required by a result of an engineering investigation. The region traffic engineer must approve the use of sign flag boards upon completion of the investigation. Evaluate sign flag boards installed as a result of an engineering investigation for effectiveness within a time period of at least six months and no greater than 12 months after installation. If the

post application engineering evaluation determines that these signs should remain in place, they may remain in place upon approval by the region traffic engineer. Once approved for extended use, evaluated for further extensions on an annual basis. See below for engineering investigation and site evaluation requirements.

Many sign flag boards are presently in places that do not meet these criteria. Sign flag boards not meeting the above criteria should be removed or reviewed as part of an engineering investigation to justify their continued use.

Evaluation of yellow sign flag boards:

- Determine purpose:
  - Increase attention to traffic control devices.
  - Gain compliance with traffic control devices.
  - Reduce crashes.
- Other devices or traffic control measures currently implemented.
- Is the effectiveness of the sign flag board reduced by other devices or traffic control, or will it supplement their effectiveness?

Crash Reduction:

- Document which crash types are believed to be reduced as a result of yellow sign flag boards.
- Attach collision diagram and accident report.
- How will you measure crash reductions?

Traffic Control Device Compliance:

- With which traffic control device are drivers not complying?
- What is the compliance rate before implementation? How was it determined?
- How will you determine the compliance rate after implementation?

# Oregon Warning Sign Details

## OW7-4

Figure 70: Sign OW7-4 (SLOW TRUCKS) Detail

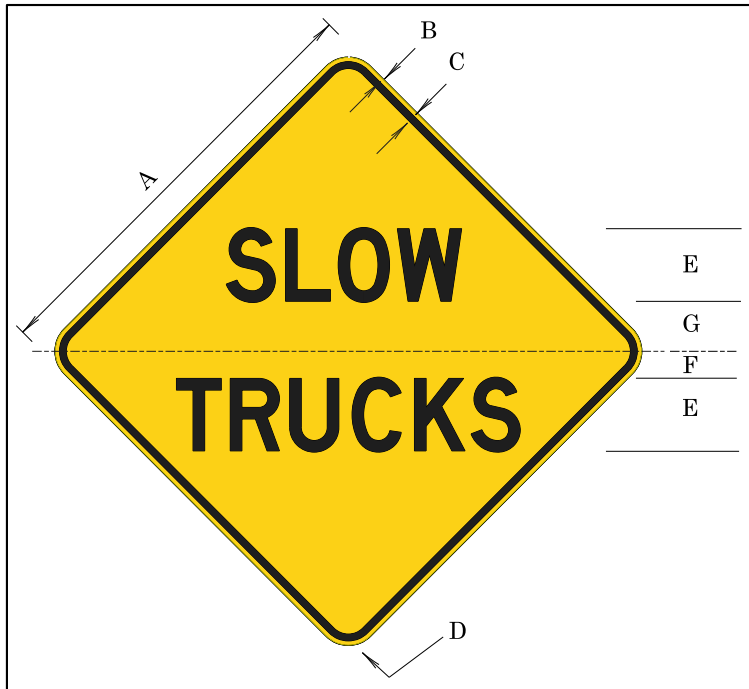

Table 71: Sign OW7-4 (SLOW TRUCKS) Dimensions (inches)

A	B	C	D	E	F	G
48 (60)	0.75	1.25	3	8D (10D)	2 (3)	4

Sign Background: Yellow, standard retroreflective sheeting.

Sign Legend: Black, non-reflective sheeting.

The SLOW TRUCKS sign should be used at the bottom of extended grades and repeated at convenient intervals on extremely long grades. It should be used use with the W7-3aP NEXT XX MILES plaque.

The OTC approved the OW7-4 (SLOW TRUCKS) sign in January 1990. The sign was last updated in February 2006.

# OW7-5

Figure 71: Sign OW7-5 (TRUCK WEIGHING AHEAD) Detail

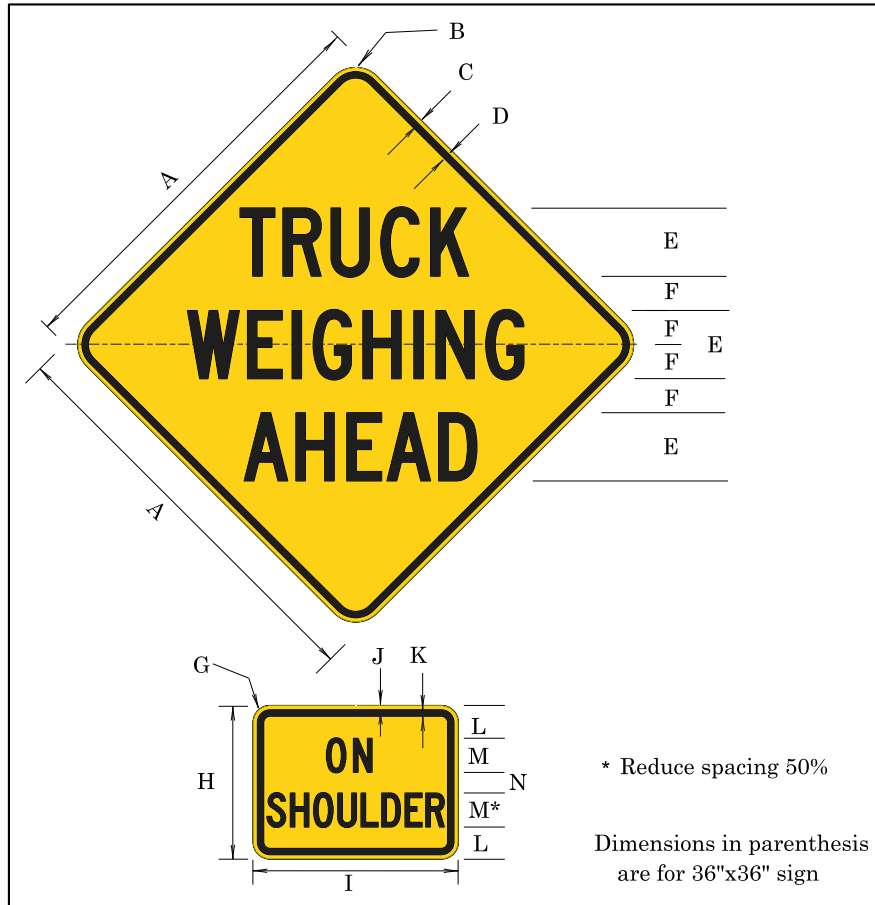

Table 72: Sign OW7-5 (TRUCK WEIGHING AHEAD) Dimensions (inches)

A	B	C	D	E	F	G	H	I	J	K	L	M	N
48 (36)	3 (2.25)	0.75 (0.625)	1.25 (0.875)	8C (6C)	4 (3)	1.5	18	24	0.375	0.625	3.75	4C	2.5

Sign Background: Yellow, standard retroreflective sheeting.

Sign Legend: Black, non-reflective sheeting.

Temporarily use the TRUCK WEIGHING AHEAD sign with the ON SHOULDER plaque during portable truck weighing operations, where motorists may encounter stopped or slow-moving trucks on the highway shoulder. Remove the signs when the weighing operation no longer exists. Minimum size - 36"x 36".

The OTC approved the OW7-5 (TRUCK WEIGHING AHEAD) sign in January 1990. The sign was last updated in December 1997.



# OW11-1a

Figure 72: Sign OW11-1a (ON ROADWAY) Detail

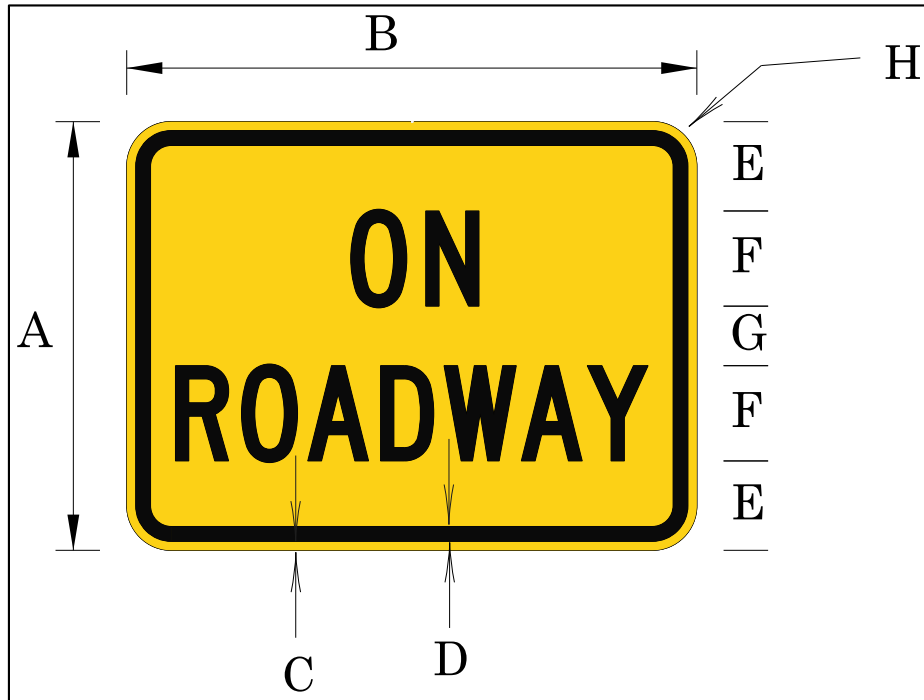

Table 73: Sign OW11-1a (ON ROADWAY) Dimensions (inches)

A	B	C	D	E	F	G	H
18	24	0.375	0.625	3.75	4C	2.5	1.5

Sign Background: Yellow, standard retroreflective sheeting.

Sign Legend: Black, non-reflective sheeting.

As a preferred alternative to SHARE THE ROAD (W16-1P), the ON ROADWAY plaque may be used with the bicycle warning symbol sign (W11-1) to remind motorists that bicycles may be present in the roadway. As appropriate, use the ON ROADWAY plaque with other applicable vehicular or non-vehicular warning symbol use of the roadway signs (W11 Series, MUTCD), where there may be unexpected entry onto or shared use of the roadway, including the ATV symbol warning sign (OW22-16). In lower speed urban areas, other signs or markings such as "BIKES MAY USE FULL LANE" (R4-11) or shared lane markings may be more appropriate.

The state traffic engineer approved the OW11-1a (ON ROADWAY) sign in January 2016.

## OW11-1b

Figure 73: Sign OW11-1b (ON SHOULDER) Detail

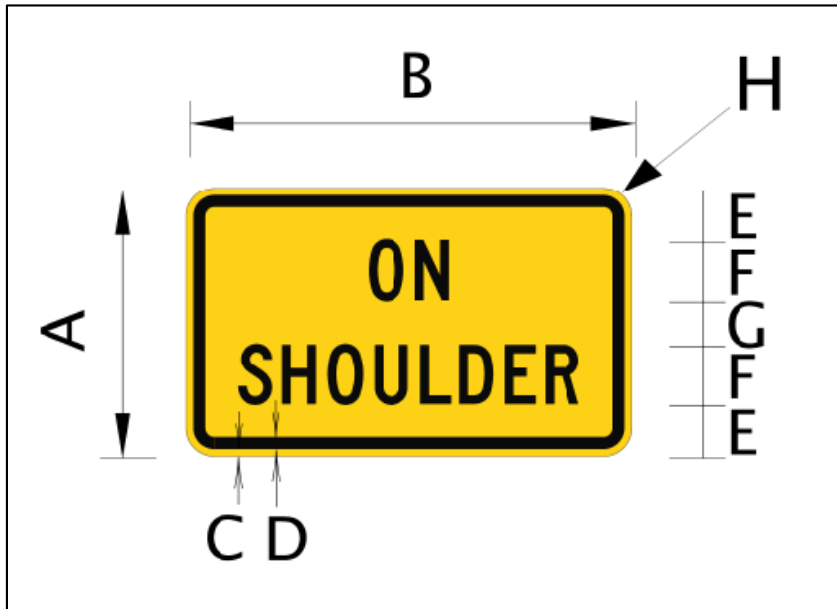

Table 74: Sign OW11-1b (ON SHOULDER) Dimensions (inches)

A	B	C	D	E	F	G	H
18	30	0.5	0.75	3.5	4C	3	1.38

Sign Background: Yellow, standard retroreflective sheeting.

Sign Legend: Black, non-reflective sheeting.

The ON SHOULDER plaque may be added as a rider to the ATV warning symbol sign (OW22-16) to denote ATV use on the shoulder of state highways. If a smaller version is needed, see plaque dimensions for sign OW7-5. The ON SHOULDER plaque may be used with other applicable vehicular or non-vehicular warning symbol use of the roadway signs (W11 Series, MUTCD), where there may be unexpected use of the roadway shoulder.

The OTC approved the OW11-1b (ON SHOULDER) sign in January 1990 as part of sign OW7-5. The sign was last updated in June 2021.

# OW11-7

Figure 74: Sign OW11-7 (OPEN RANGE) Detail

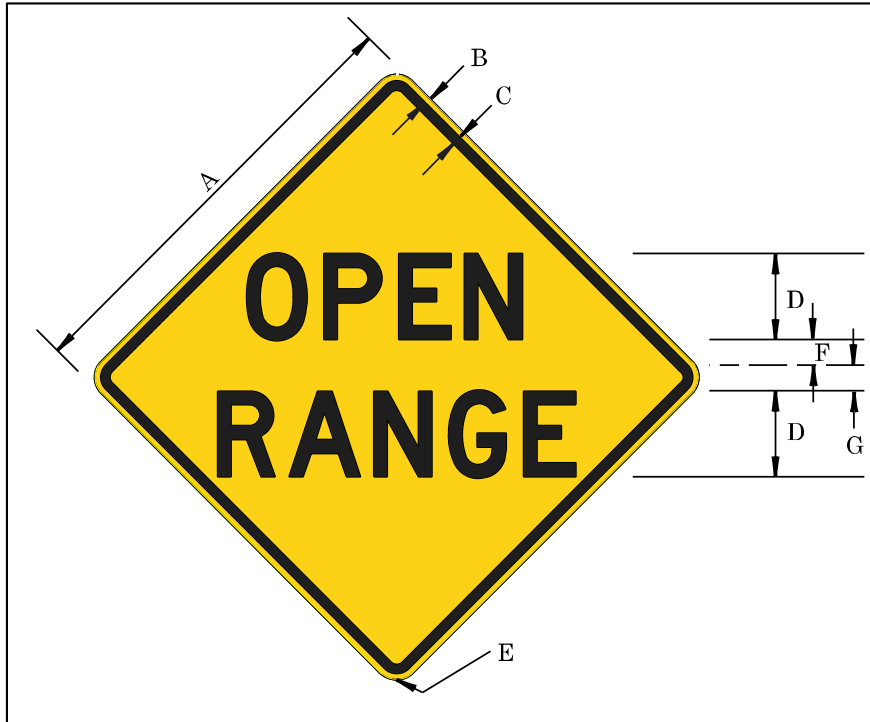

Table 75: Sign OW11-7 (OPEN RANGE) Dimensions (inches)

Sign Size	A	B	C	D	E	F	G
Minimum	30	0.5	0.75	6C	1.875	2	2
Standard	36	0.625	0.875	7D	2.25	3	0
Special	48	0.75	1.25	8D	3	3	3

Sign Background: Yellow, standard retroreflective sheeting.

Sign Legend: Black, non-reflective sheeting.

The OPEN RANGE sign may be used to warn motorists of areas where livestock are permitted to roam without the benefit of fences.

The state traffic engineer approved the OW11-7 (OPEN RANGE) sign in September 1999.

# OW12-2P

Figure 75: Sign OW12-2P (Low Clearance) Detail

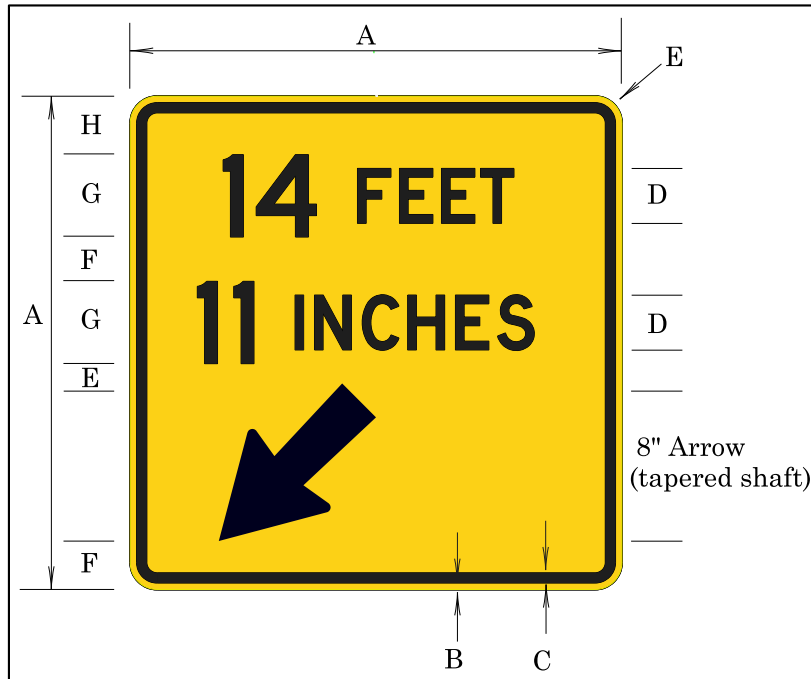

Table 76: Sign OW12-2P (Low Clearance) Dimensions (inches)

A	B	C	D	E	F	G	H
36	0.625	0.875	4D	2.25	3.25	6D	4.25

Sign Background: Yellow, standard retroreflective sheeting.

Sign Legend: Black, non-reflective sheeting.

The Low Clearance sign (OW12-2P) shall be used to warn motorists of clearances less than 15 feet between the roadway or the shoulder and a given structure. The sign shall consist of the low clearance dimension and an arrow directed at the low clearance point. Mount the sign on the structure.

This sign shall be used in conjunction with the "LOW CLEARANCE" Sign (W12-2).

The OTC approved the OW12-2P (Low Clearance) sign in January 1990. The sign was last updated in July 2014.

# OW14-3

Figure 76: Sign OW14-3 (PRIVATE DRIVE) Detail

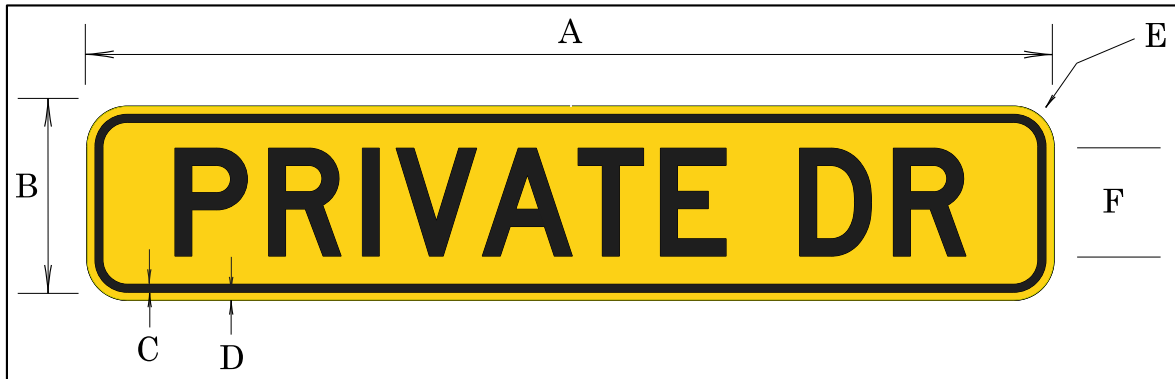

Table 77: Sign OW14-3 (PRIVATE DRIVE) Dimensions (inches)

Sign Size	A	B	C	D	E	F
Minimum	36	9	0.375	0.375	1.5	4D
Standard	45	9	0.375	0.375	1.5	5D
Special	54	12	0.75	0.5	1.5	6D

Sign Background: Yellow, standard retroreflective sheeting.

Sign Legend: Black, non-reflective sheeting.

The PRIVATE DRIVE sign should be placed below a private street/road name sign.

The state traffic engineer approved the OW14-3 (PRIVATE DRIVE) sign in September 2000.

# OW15-1

Figure 77: Sign OW15-1 (SLOW) Detail

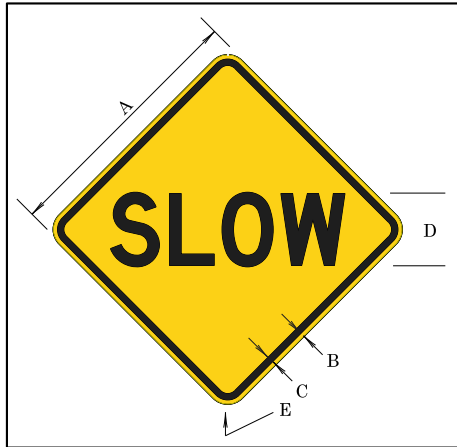

Table 78: Sign OW15-1 (SLOW) Dimensions (inches)

Sign	A	B	C	D	E
Minimum	30	0.5	0.75	8D	1.875
Standard	36	0.625	0.875	10D	2.25
Work Zone	48	0.75	1.25	14D	3

Sign Background: Yellow, standard retroreflective sheeting.

Work Zone Sign Background: Orange, retroreflective sheeting.

Incident Management Sign Background: Fluorescent pink, retroreflective sheeting.

Sign Legend: Black, non-reflective sheeting.

Restrict the use of the SLOW sign to locations which require utmost caution and generally an appreciable reduction in speed by motorists. It shall always be followed with a second warning sign indicating the reason for reducing speed.

When used in conjunction with a turn or curve sign, its use shall be restricted to those curves on which the comfortable safe speed is at least 25 MPH lower than the prevailing speeds on the approach. The sign is for emphasis only; therefore, use it sparingly to prevent ineffectiveness.

Erect the SLOW sign at least 200 feet in advance of the warning signs.

The OTC approved the OW15-1 (SLOW) sign in January 1990. The sign was last updated in September 2006.

# OW15-6

Figure 78: Sign OW15-6 (CONGESTION) Detail

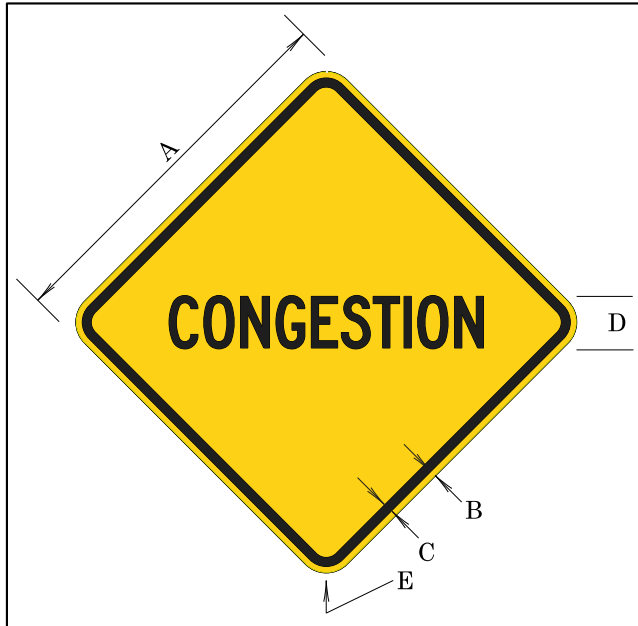

Table 79: Sign OW15-6 (CONGESTION) Dimensions (inches)

Sign Size	A	B	C	D	E
Minimum	30	0.5	0.75	4.5C	1.875
Standard	36	0.625	0.875	5C	2.25

Sign Background: Yellow, standard retroreflective sheeting.

Sign Legend: Black, non-reflective sheeting.

The CONGESTION sign may be used in advance of isolated sections of roadside development through which a reduction of speed is necessary, but which are too short to warrant the establishment of a speed zone. It may also be used within speed zones to call the motorist's attention to sections which are too short to justify a lower speed, but which experience congested conditions requiring a lower speed than that indicated.

The need for this sign should be determined upon the basis of an engineering and traffic investigation. This sign shall not be used on the interstate highway system. The message is not intended for interstate use.

The OTC approved the OW15-6 (CONGESTION) sign in January 1990. The sign was last updated in November 2007.

# OW15-11

Figure 79: Sign OW15-11 (TUNNEL) Detail

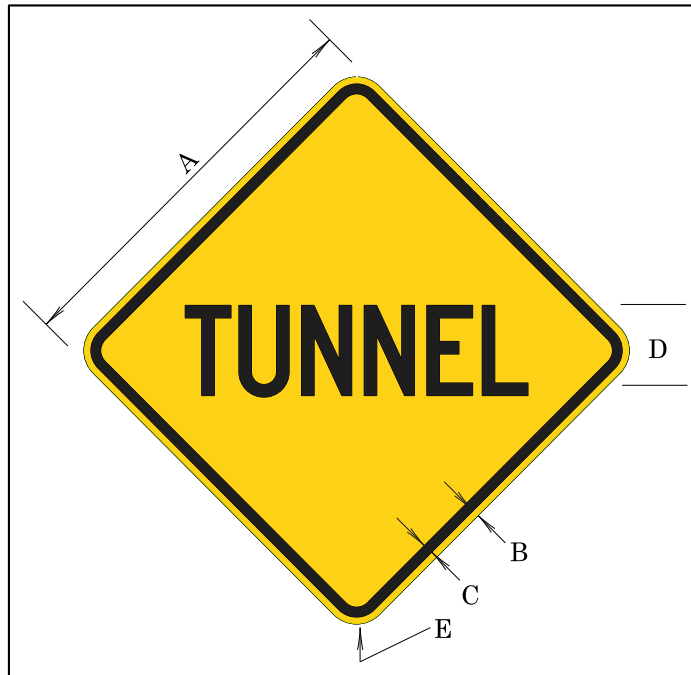

Table 80: Sign OW15-11 (TUNNEL) Dimensions (inches)

Sign Size	A	B	C	D	E
Minimum	30	0.5	0.75	7C	1.875
Standard	36	0.625	0.875	8C	2.25
Freeway/Expressway	48	0.75	1.25	10C	3

Sign Background: Yellow, standard retroreflective sheeting.

Sign Legend: Black, non-reflective sheeting.

The TUNNEL sign shall be used in advance of all tunnels to warn motorists of their existence.

The OTC approved the OW15-11 (TUNNEL) sign in January 1990. The sign was last updated in September 2000.



# OW15-12

Figure 80: Sign OW15-12 (HIGH WATER) Detail

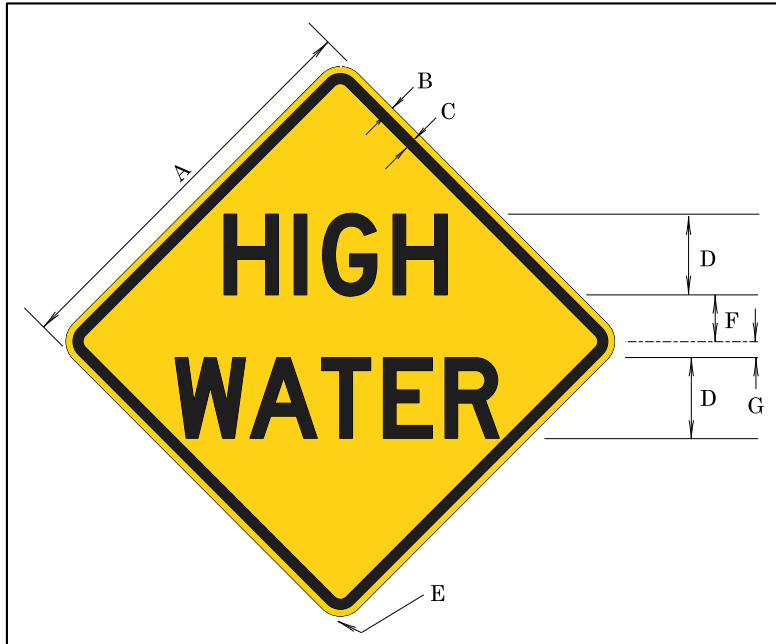

Table 81: Sign OW15-12 (HIGH WATER) Dimension (inches)

Sign Size	A	B	C	D	E	F	G
Minimum	24	0.375	0.625	5C	1.5	3	0
Standard	30	0.5	0.75	6D	1.875	3.5	0
Special	36	0.625	0.875	7C	2.25	4.25	1.25
Special	48	0.75	1.25	8D	3	6.5	2

Sign Background: Yellow, standard retroreflective sheeting.

Sign Legend: Black, non-reflective sheeting.

The HIGH WATER sign should be used to warn motorists of high water covering a roadway surface which is passable. Use the sign temporarily; remove or cover the sign when the hazard no longer exists.

Erect the sign on the right-hand side of the roadway. As needed or appropriate, mount an additional sign on a portable support in the median on multi-lane roadways.

The OTC approved the OW15-12 (HIGH WATER) sign in January 1990. The sign was last updated in December 1997.

# OW15-14

Figure 81: Sign OW15-12 (PREPARE TO STOP WHEN LIGHTS FLASH) Detail

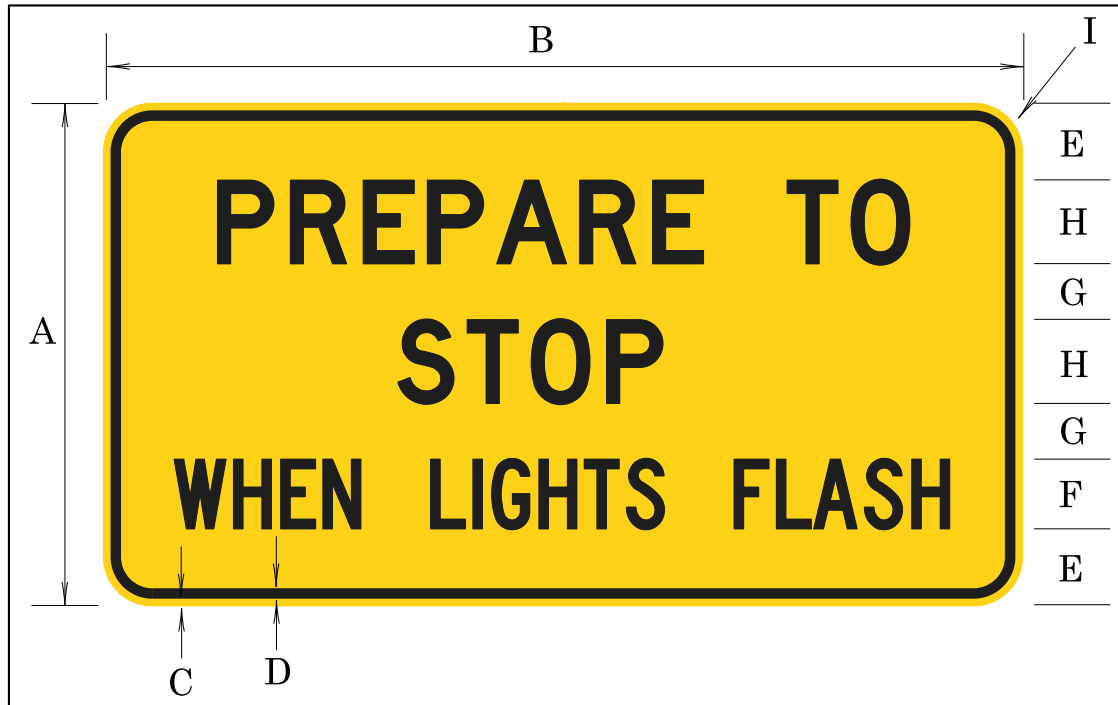

Table 82: Sign OW15-12 (PREPARE TO STOP WHEN LIGHTS FLASH) Dimensions (inches)

A	B	C	D	E	F	G	H	I
36	66	0.75	1.25	5.5	5C	4	6D	3

Sign Background: Yellow, standard retroreflective sheeting.

Sign Legend: Black, non-reflective sheeting.

The PREPARE TO STOP WHEN LIGHTS FLASH sign shall be a horizontal rectangle with two yellow flashing beacons above the sign. It may be used in advance of a traffic control signal, or a special application thereof, when sight distance or other conditions require an early warning.

The state traffic-roadway engineer must approve the use of this sign on the state highway system. Document the need for such a sign with an engineering study that addresses the second standard (paragraph 7) of MUTCD Section 4D.12. Designers must consider the Dilemma Zone protection in the design. (ODOT Traffic Signal Design Manual, Chapter 12.)

The OTC approved the OW15-12 (PREPARE TO STOP WHEN LIGHTS FLASH) sign in January 1990. The sign was last updated in July 2014.

# OW15-15

Figure 82: Sign OW15-15 (SNOW ZONE) Detail

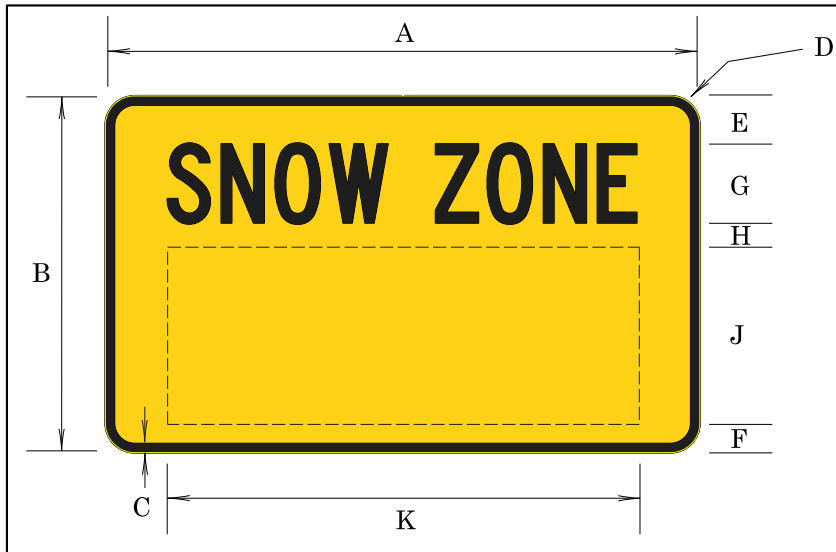

Table 83: Sign OW15-15 (SNOW ZONE) Dimension (inches)

Sign Size	A	B	C	D	E	F	G	H	J	K
Standard	60	36	1	3	5	2.5	8C	2.5	18	48
Freeway/Expressway	96	48	1	6	5	4.5	8E	3.5	27	66

Sign Background: Yellow, standard retroreflective sheeting.

Sign Legend: Black, non-reflective sheeting.

The SNOW ZONE sign, with interchangeable riders, may be used during the snow season in mountain areas.

During the snow season, the CARRY CHAINS OR TRACTION TIRES (OR15-15A) rider should be displayed when the following messages are not applicable:

- CHAINS REQUIRED ON VEHICLES TOWING OR OVER 10,000 GVW (OR15-15B).
- CHAINS REQUIRED, TRACTION TIRES ALLOWED ON VEHICLES UNDER 10,000 GVW (OR15-15C).
- CHAINS REQUIRED ON VEHICLES TOWING OR SINGLE DRIVE AXLE OVER 10,000 GVW (OR15-15D).

Display a blank rider during the season(s) when snow is not normally expected.

The state traffic engineer approved the OW15-15 (SNOW ZONE) sign in September 1997. The sign was last updated in January 2014.

# OW15-16

Please note: Motor carrier use only.

Figure 83: Sign OW15-16 (OVERSIZE LOAD) Detail

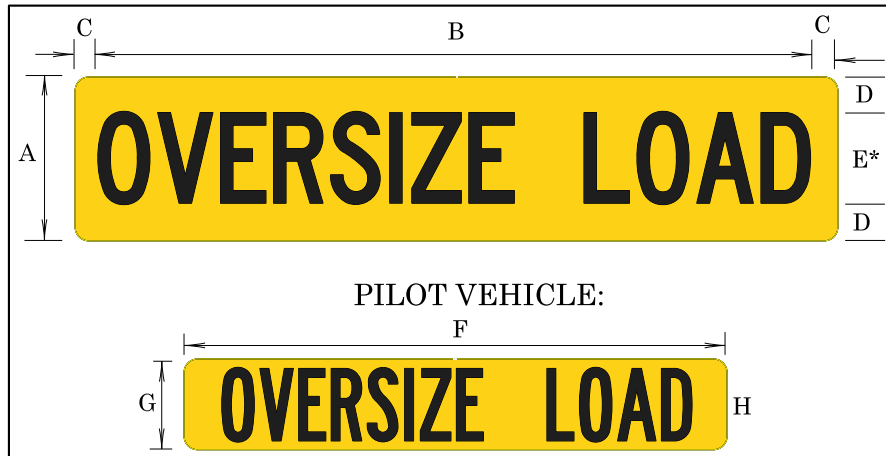

Table 84: Sign OW15-16 (OVERSIZE LOAD) Dimensions (inches)

A	B	C	D	E	F	G	H
18	79	2.5	4	10C	60	10	8B

\*Reduce Intra letter spacing 30%

Sign Background: Yellow.

Sign Legend: Black.

The OVERSIZE LOAD sign shall be used to warn motorists of a vehicle, including load, which is wider or longer than the legal limit and is operating over state or county highways or city streets, by written permit of the authority having jurisdiction over the highway or street.

To enhance visibility of signs, the following are allowed: Borders, larger legends, and/or reflective backgrounds.

Signs used on hauling vehicles between sunset and sunrise shall be made of reflectorized material.

This sign is in support of OAR 734-075-0035, 734-075-0045, 734-076-0135, 734-076-0165, 734-078-0030, 734-078-0035, 734-082-0035, and 734-082-0037.

The OTC approved the OW15-16 (OVERSIZE LOAD) sign in January 1990. The sign was last updated in December 2011.

# OW15-17

Please note: Motor carrier use only.

Figure 84: Sign OW15-17 (LONG LOAD) Detail



Table 85: Sign OW15-17 (LONG LOAD) Dimensions (inches)

A	B	C	D
18	84	4	10E

Sign Background: Yellow.

Sign Legend: Black.

The LONG LOAD warning sign is for vehicle combinations exceeding 75' in overall length, excluding combinations of vehicles authorized by the Surface Transportation Assistance Act of 1982.

Display the warning sign on the back of the rearmost trailer or semitrailer.

The sign shall be positioned at such height as to be readily visible to following drivers. Operators must keep the sign in good repair, free from dirt, grease and "road film" in order that it may be clearly readable to following drivers.

Signs made of mesh or other materials that do not provide a continuous background are not permitted.

Signs used on hauling vehicles between sunset and sunrise shall be made of reflectorized material.

This sign is in support of OAR 734-074-0060.

The state traffic engineer approved the OW15-17 (LONG LOAD) sign in March 1994. The sign was last updated in December 2011.

# OW15-17a

Please note: Motor carrier use only.

Figure 85: Sign OW15-17a (LONG LOAD) Detail

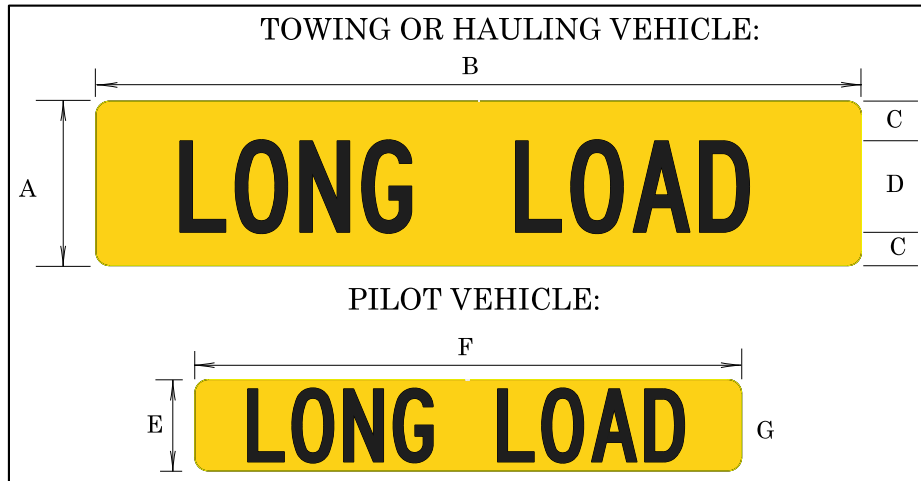

Table 86: Sign OW15-17a (LONG LOAD) Dimensions (inches)

A	B	C	D	E	F	G
18	84	4	10C	10	60	8C

Sign Background: Yellow.

Sign Legend: Black.

The LONG LOAD warning sign is for vehicles transporting loads which are not over 8'-6" wide and the vehicle and overhang are not over 80 feet in total length. May be used on county highways or city streets, by written permit of the authority having jurisdiction over the highway or street.

To enhance visibility of signs the following are allowed: borders, larger legends, and/or reflective background.

Signs made of mesh or other materials that do not provide a continuous background are not permitted.

Signs used on hauling vehicles between sunset and sunrise shall be made of reflectorized material.

This sign is in support of OAR 734-074-0060, 734-076-0135, 734-076-0165, 734-078-0030, and 734-082-0037.

The state traffic engineer approved the OW15-17a (LONG LOAD) sign in March 1994. The sign was last updated in December 2011.



# OW15-18

Please note: Motor carrier use only.

Figure 86: Sign OW15-18 (WIDE LOAD) Detail

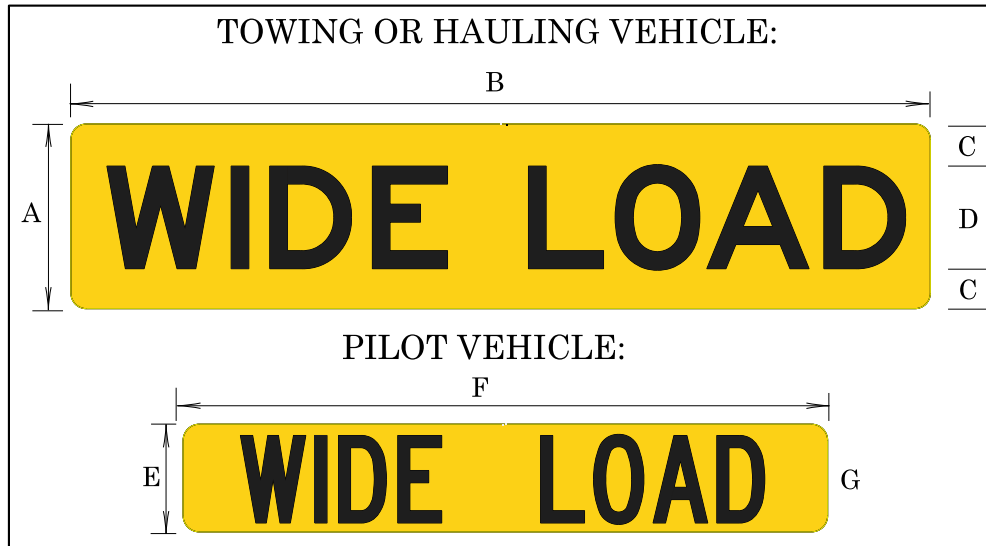

Table 87: Sign OW15-18 (WIDE LOAD) Dimensions (inches)

A	B	C	D	E	F	G
18	84	4	10E	10	60	8C

Sign Background: Yellow.

Sign Legend: Black.

Use this warning sign for vehicles transporting loads, which are wide only and under 80 feet long.

To enhance visibility of signs the following are allowed: borders, larger legend, and/or reflective background.

Signs made of mesh or other materials that do not provide a continuous background are not permitted.

Signs used on hauling vehicles between sunset and sunrise shall be made of reflectorized material.

This sign is in support of OAR 734-076-0135 and 734-082-0037.

The state traffic engineer approved the OW15-18 (WIDE LOAD) sign in March 1994. The sign was last updated in December 2011.

## OW15-19

Figure 87: Sign OW15-19 (SLIDES) Detail

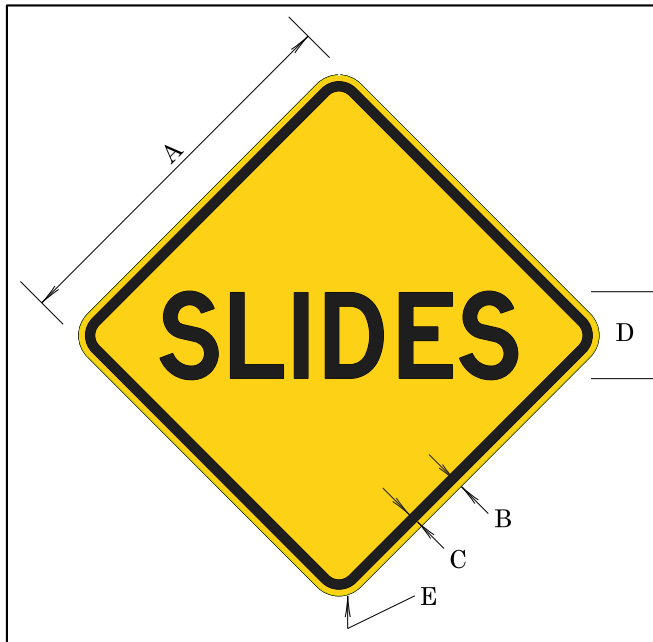

Table 88: Sign OW15-19 (SLIDES) Dimensions (inches)

Sign Size	A	B	C	D	E
Minimum	30	0.5	0.75	7C	1.875
Standard	36	0.625	0.875	8C	2.25
Freeway	48	0.75	1.25	11D	3

Sign Background: Yellow, standard retroreflective sheeting.

Sign Legend: Black, non-reflective sheeting.

The SLIDES sign should be used to warn motorists that they may encounter earth or rock slides on the roadway of a highway section.

The OTC approved the OW15-19 (SLIDES) sign in January 1990. The sign was last updated in September 2000.

# OW16-10

Figure 88: Sign OW16-10 (BYPASS PHOTO ENFORCED) Detail

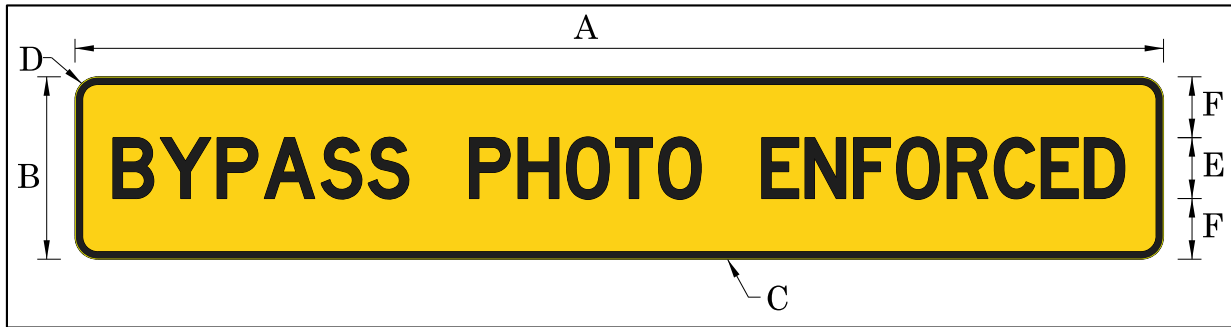

Table 89: Sign OW16-10 (BYPASS PHOTO ENFORCED) Dimensions (inches)

Sign Size	A	B	C	D	E	F
Standard	96	18	1	3	5D	6.5
Freeway/Expressway	144	24	1	3	8D*	8

Sign Background: Yellow, standard retroreflective sheeting.

Sign Legend: Black, non-reflective sheeting.

The BYPASS PHOTO ENFORCED sign may be used under the OR22-4 ALL TRUCKS OVER 20,000 GVW NEXT RIGHT sign to warn drivers the weigh station may use a video camera to identify trucks that don't stop at the weigh station as required.

The state traffic engineer approved the OW16-10 (BYPASS PHOTO ENFORCED) sign in July 2008. The sign was last updated in September 2009.

# OW21-1

Please note: Motor carrier use only.

Figure 89: Sign OW21-1 (STOP AHEAD) Detail



Table 90: Sign OW21-1 (STOP AHEAD) Dimensions (inches)

A	B	C
10	60	8C

Sign Background: Fluorescent yellow, type IX retroreflective sheeting (sheet aluminum).

Sign Legend: Black, non-reflective sheeting.

The STOP AHEAD sign shall be used on the advance pilot car when traffic is stopped to allow a wide or oversize load to be towed through a tunnel or other restricted width section of highway. Only use this sign when required by permit.

The state traffic engineer approved the OW21-1 (STOP AHEAD) sign in September 1999.

# OW21-4

Figure 90: Sign OW21-4 (BRAKE CHECK AREA) Detail

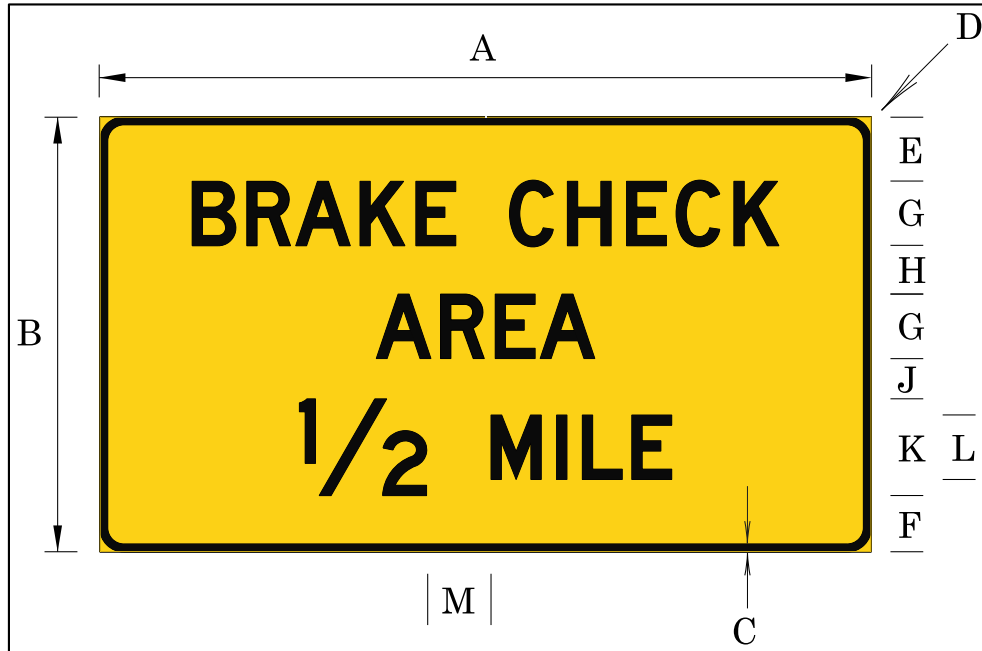

Table 91: Sign OW21-4 (BRAKE CHECK AREA) Dimensions (inches)

Sign Size	A	B	C	D	E	F	G	H	J	K	L	M
Standard	96	54	1	3	8	7	8D	6	5	12	8D	8
Freeway/Expressway	132	66	2	6	10	8	10E	8	8	12	8E	12

Sign Background: Yellow, standard retroreflective sheeting.

Sign Legend: Black, non-reflective sheeting.

BRAKE CHECK AREA signs - OW21-4 to OW21-6 (See [chapter 5, section Brake Check Area Signs & Chain-Up Area Signs](#) and MUTCD section 2I.06 for related information).

Use the BRAKE CHECK AREA signs to identify those areas adjacent to the highway maintained for the purpose of providing truckers with an area for checking their air brakes and ensuring adequate pressure for navigating long, downhill grades.

The BRAKE CHECK AREA 1/2 MILE sign should be installed approximately 1/2 mile in advance of the brake check area. Install the BRAKE CHECK AREA sign (OW21-5 or OW21-6) at the beginning of the brake check area.

The state traffic engineer approved the OW21-4 (BRAKE CHECK AREA) sign in March 2015.

## OW21-5 & OW21-6

Figure 91: Sign OW21-5 & OW21-6 (BRAKE CHECK AREA) Detail

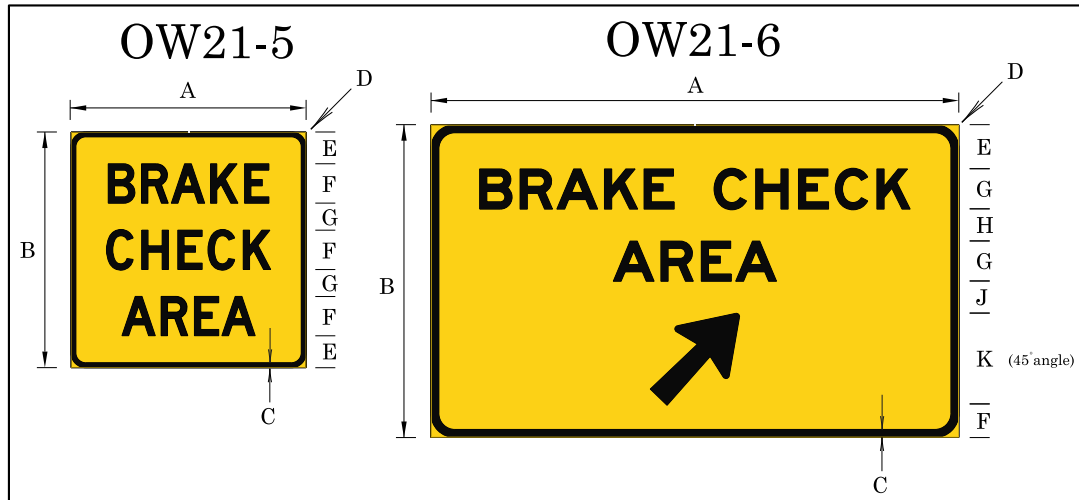

Table 92: Sign OW21-5 (BRAKE CHECK AREA) Dimensions (inches)

Sign Size	A	B	C	D	E	F	G
Standard	48	48	1	3	6.5	8D	5.5
Freeway/Expressway	72	66	2	6	10	10E	8

Table 93: Sign OW21-6 (BRAKE CHECK AREA) Dimensions (inches)

Sign Size	A	B	C	D	E	F	G	H	J	K
Standard	96	54	1	3	7	6.5	8D	6	6.5	Type D, 10x15
Freeway/Expressway	132	78	2	6	11	8	10E	8	8	Type A-2, 18x29

Sign Background: Yellow, standard retroreflective sheeting.

Sign Legend: Black, non-reflective sheeting.

BRAKE CHECK AREA SIGNS - OW21-4 to OW21-6 (See [chapter 5, section Brake Check Area Signs & Chain-Up Area Signs](#) and MUTCD section 2I.06 for related information.)

The state traffic engineer approved the OW21-5 & 21-6 (BRAKE CHECK AREA SIGNS) sign in March 2015.

# OW22-1a

Figure 92: Sign OW22-1a (CHAIN-UP AREA) Detail

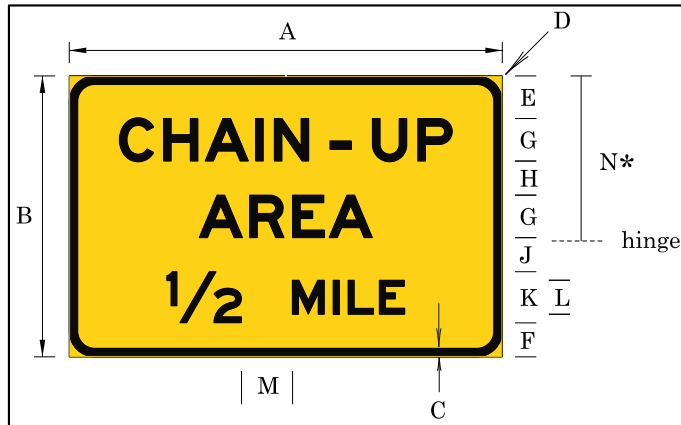

Table 94: Sign OW22-1a (CHAIN-UP AREA) Dimensions (inches)

Sign Size	A	B	C	D	E	F	G	H	J	K	L	M	N
Standard	72	54	1	3	8	7	8D	6	5	12	8D	12	30
Freeway/Expressway	96	66	2	6	10	8	10E	8	8	12	8E	12	39

\*Plywood version of sign may be fabricated in two pieces and hinged to allow for “folding down” of sign.

Sign Background: Yellow, standard retroreflective sheeting.

Sign Legend: Black, non-reflective sheeting.

CHAIN-UP AREA signs - OW22-1a to OW22-3 (See [chapter 5, section Brake Check Area Signs & Chain-Up Area Signs](#) and MUTCD section 2I.07 for related information). Use the CHAIN-UP AREA signs to identify areas adjacent to the highway maintained for the purpose of installing tire chains or traction devices. The signs should be installed as follows:

- Install the CHAIN-UP AREA 1/2 MILE sign approximately 1/2 mile in advance of the chain-up area.
- Install the SNOW ZONE sign (OW15-15) approximately 800 feet in advance of the chain-up area.
- Install the CHAIN-UP AREA sign (OW22-2 or OW22-3) at the beginning of the chain-up area.

The signs are rectangular in shape and may hinge near the middle. The signs should be either folded down or cover upped when not needed.

The state traffic engineer approved the OW22-1a (Chain-Up Area) sign in March 1998. The sign was last updated in January 2014.



## OW22-2 & OW22-3

Figure 93: Sign OW22-2 & OW22-3 (CHAIN-UP AREA) Detail

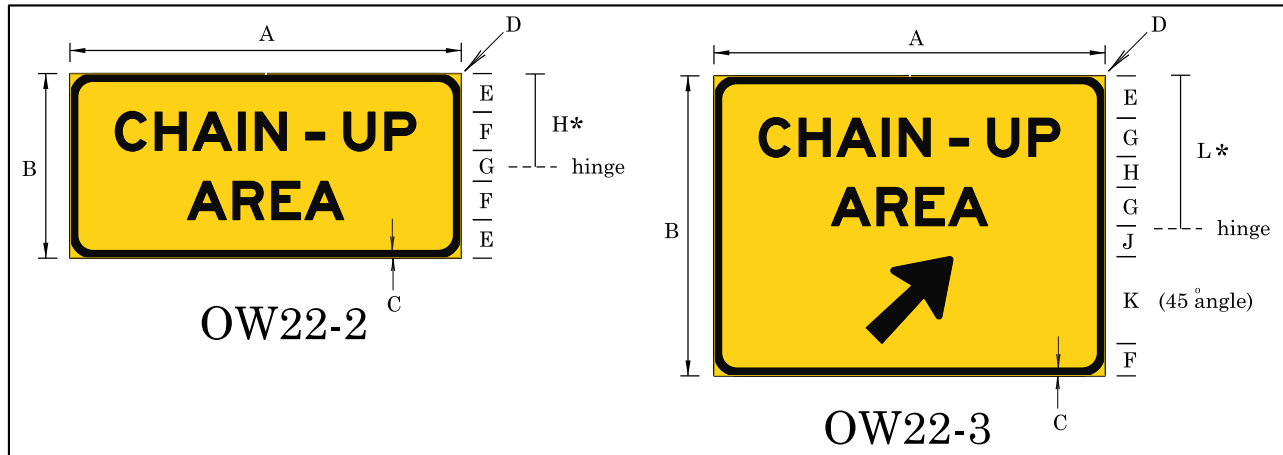

Table 95: Sign OW22-2 (CHAIN-UP AREA) Dimensions (inches)

Sign Size	A	B	C	D	E	F	G	H
Standard	72	36	1	3	7	8D	6	18
Freeway/Expressway	96	48	2	6	10	10E	8	24

Table 96: Sign OW22-3 (CHAIN-UP AREA) Dimensions (inches)

Sign Size	A	B	C	D	E	F	G	H	J	K	L
Standard	72	54	1	3	7	6.5	8D	6	6.5	Type D, 10x15	30
Freeway/Expressway	96	78	2	6	11	8.5	10E	8	8	Type A-2, 18x29	39

\*Plywood version of sign may be fabricated in two pieces and hinged to allow for “folding down” of sign.

CHAIN-UP AREA SIGNS - OW22-1a to OW22-3 (See [chapter 5, section Brake Check Area Signs & Chain-Up Area Signs](#) and MUTCD section 2I.07 for related information).

The state traffic engineer approved the OW22-2 & OW22-3 (CHAIN-UP AREA) sign in March 1998. The sign was last updated in January 2014.

# OW22-4a

Figure 94: Sign OW22-4a (CHAIN REMOVAL AREA) Detail

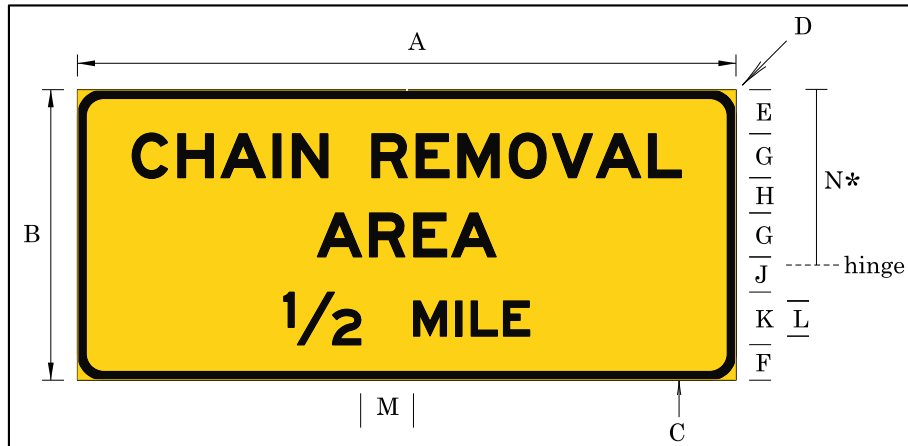

Table 97: Sign OW22-4a (CHAIN REMOVAL AREA) Dimensions (inches)

Sign Type	A	B	C	D	E	F	G	H	J	K	L	M	N
Standard	96	54	1	3	8	7	8D	6	5	12	8D	12	30
Freeway/Expressway	144	66	2	6	10	8	10E	8	8	12	8E	12	NA

\*Plywood version of sign may be fabricated in two pieces and hinged to allow for “folding down” of sign.

Sign Background: Yellow, standard retroreflective sheeting.

Sign Legend: Black, non-reflective sheeting.

CHAIN REMOVAL AREA signs - OW22-4a to OW22-6 (See [chapter 5, section Brake Check Area Signs & Chain-Up Area Signs](#) and MUTCD section 2I.07 for related information). Use the CHAIN REMOVAL AREA signs to identify those areas adjacent to the highway maintained for the purpose of removing tire chains or traction devices. The signs should be installed as follows:

- Install the CHAIN REMOVAL AREA 1/2 MILE sign approximately 1/2 mile in advance of the chain removal area.
- Install the CHAIN REMOVAL AREA sign (OW22-5 or OW22-6) at the beginning of the chain removal area.

The signs are rectangular in shape and may hinge near the middle. When not needed, the signs should be either folded down or cover upped.

The state traffic engineer approved the OW22-4a (CHAIN REMOVAL AREA) sign in January 1990. The sign was last updated in January 2014.

## OW22-5 & OW22-6

Figure 95: Sign OW22-5 & OW22-6 (CHAIN REMOVAL AREA) Detail

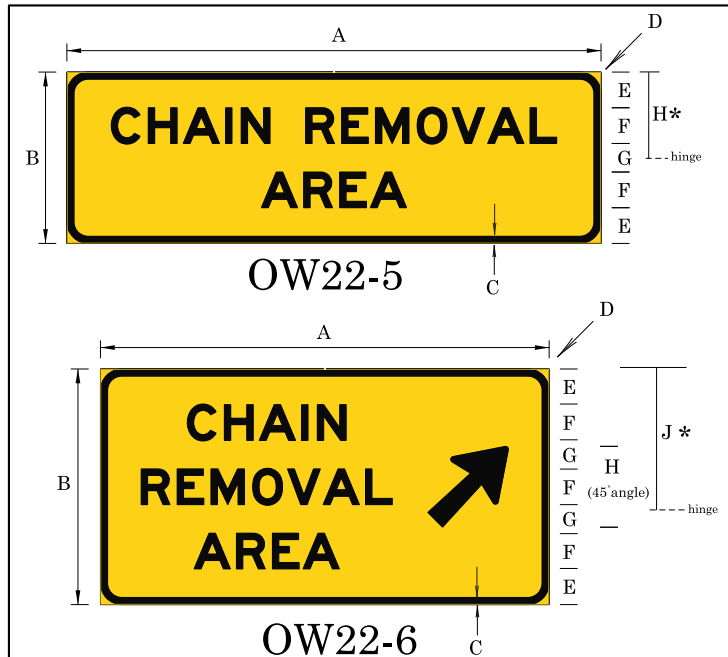

Table 98: Sign OW22-5 (CHAIN REMOVAL AREA) Dimensions (inches)

Sign Size	A	B	C	D	E	F	G	H
Standard	96	36	1	3	7	8D	6	18
Freeway/Expressway	144	48	2	6	10	10E	8	NA

Table 99: Sign OW22-6 (CHAIN REMOVAL AREA) Dimensions (inches)

Sign Size	A	B	C	D	E	F	G	H	J
Standard	96	54	1	3	8	8D	7	Type D, 10x15	33
Freeway/Expressway	126	66	2	6	10	10E	8	Type A-2, 18x29	NA

\*Plywood version of sign may be fabricated in two pieces and hinged to allow for “folding down” of sign.

Sign Background: Yellow, standard retroreflective sheeting.

Sign Legend: Black, non-reflective sheeting.

CHAIN REMOVAL AREA SIGNS - OW22-4a to OW22-6 (See [chapter 5, section Brake Check Area Signs & Chain-Up Area Signs](#) and MUTCD section 2I.07 for related information).

The state traffic engineer approved the OW22-5 & OW22-6 (CHAIN REMOVAL AREA) signs in March 1994. The sign was last updated in January 2014.

**OW22-7**

Figure 96: Sign OW22-7 (Highway Advisory Radio) Detail

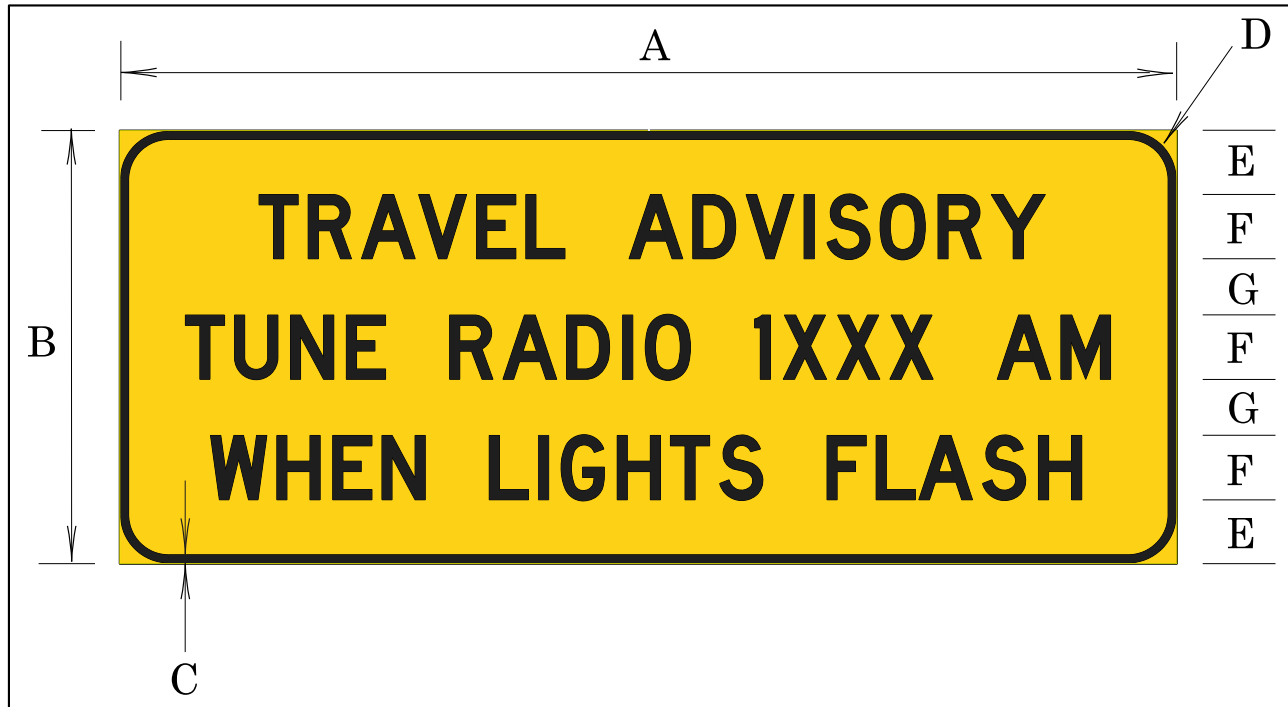

Table 100: Sign OW22-7 (Highway Advisory Radio) Dimensions (inches)

Sign Type	A	B	C	D	E	F	G
Low Volume/Low Speed	96	42	1	6	6.5	6D	5.5
Standard	132	54	1	6	8	8D	7
Freeway/Expressway	162	66	1	9	9.5	10D	8.5

Sign Background: Yellow, standard retroreflective sheeting.

Sign Legend: Black, non-reflective sheeting.

The Highway Advisory Radio sign may be used at locations with an authorized Travelers Information Station. Maintenance & Operations Branch’s Guidelines for the Operation of Highway Advisory Radio and Other Travelers Information Stations on State Highways governs ODOT’s use of traveler information stations.

The state traffic engineer approved the OW22-7 (Highway Advisory Radio) sign in May 2007.

# OW22-15

Figure 97: Sign OW22-15 (NO LANE CHANGES AHEAD) Detail

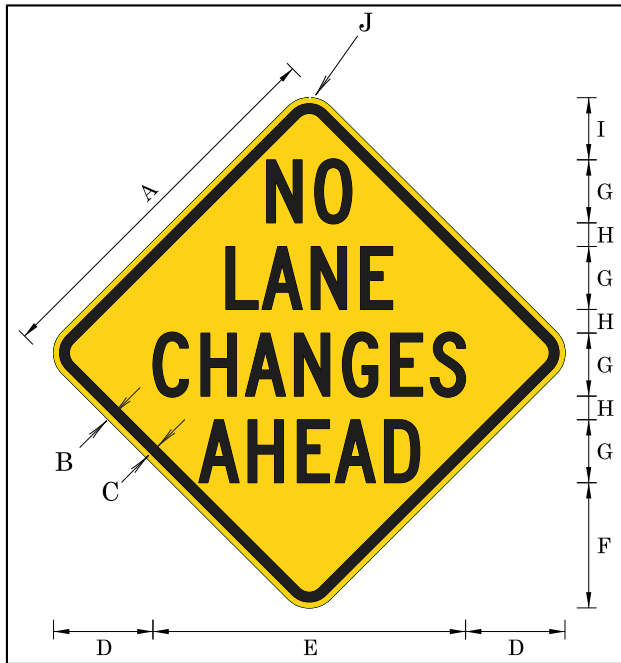

Table 101: Sign OW22-15 (NO LANE CHANGES AHEAD) Dimension (inches)

A	B	C	D	E	F	G	H	I	J
48	0.75	1.25	12.6	39.6	15.9	8C	3	7.9	3

Sign Background: Yellow, standard retroreflective sheeting.

Sign Legend: Black, non-reflective sheeting.

Use the NO LANE CHANGES AHEAD sign to direct and inform motorists that a no lane change area is approaching.

Size shown is for freeway use; use 6"C letters on a 36" x 36" sign for non-freeway applications.

The state traffic engineer approved the OW22-15 (NO LANE CHANGES AHEAD) sign in December 2011.

# OW22-16

Figure 98: Sign OW22-16 (ATV Warning Symbol Sign) Detail

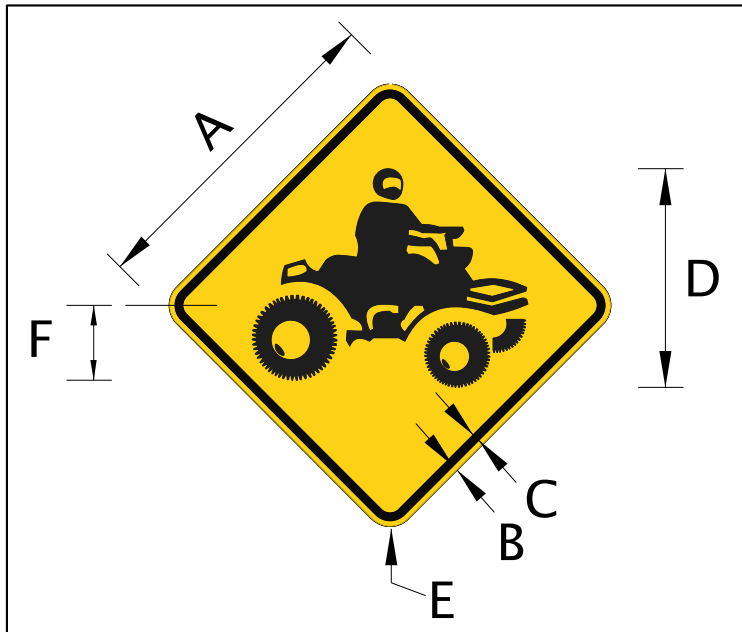

Table 102: Sign OW22-16 (ATV Warning Symbol Sign) Dimension (inches)

Sign type	A	B	C	D	E	F
Minimum	30	0.5	0.75	20	1.875	7
Standard	36	0.625	0.875	24	2.25	9
Oversized	48	0.75	1.25	32	3	12

Sign Background: Yellow, standard retroreflective sheeting.

Sign Legend: Black, non-reflective sheeting.

The ATV warning symbol sign may be used at ATV crossings of roadways and along approved ATV highway access routes. Contact the Traffic-Roadway Section for locations and questions related to ATV highway access routes.

The state traffic engineer approved the OW22-16 (ATV warning symbol) sign in February 2018.

## **Chapter 5: Guide Signs**

It is important to remember that if a policy exists and the sign meets the necessary criteria, the sign will be erected only when there is adequate space along the highway or freeway, and only if the designated location generates a large enough traffic volume to justify the placement of the sign. Funds and availability of our maintenance forces may also factor in.

### **Chapter 5A-Conventional Roads**

#### **Arrows (MUTCD 2D.08)**

The directional arrows on guide signs should be determined by the height of the legend.

- Use 4" x 6" arrows for 4" legend.
- Use 5" x 7" arrows for 5" legend.
- Use 6" x 9" arrows for 6" legend.
- Use 8" x 12" arrows for 8" legend.

The length of the arrow may be increased if the sign layout allows a longer arrow.

#### **Design of Route Signs (MUTCD 2D.11)**

Route markers incorporated into guide sign legends shall have a minimum size of 18" x 18". Route markers installed elsewhere shall be a minimum of 24" x 24" except rural route shields that may be 18" x 18". See Standard Drawings TM211 and TM212.

#### **Destination Signs (D1 Series) (MUTCD 2D.37)**

A white line shall separate all destinations in different directions. All destinations in a given direction shall share one directional arrow.

The importance of the sign governs the legend size and style. All legends on a single sign shall be the same size and style.

Not more than four destinations should be shown on a conventional road destination sign. Mileage should be shown, except in urban areas.

#### **Location of Destination Signs (MUTCD 2D.40)**

Use the listing in part 3, of Intersection Guide Sign Guidelines section below, to prioritize guide signs.



## **Signing of Named Highways (MUTCD 2D.53)**

Memorial highways may be signed in rest areas, scenic turnouts, or similar places where the motorist can safely park their vehicle to read the marker or sign.

### **Intersection Guide Sign Guidelines**

1. Definitions:

**Rural** – The area outside the urban growth boundary of any incorporated city.

**Urban** – The area inside the city limits and extending to the urban growth boundary of any incorporated city.

**Advance Guide Sign** – Guide signs placed prior to an intersection that include next left, next right, distance, direction, or arrow direction.

**Guide Sign** – Sign giving direction that may be green, brown, or blue background depending on legend content.

2. A maximum of three destinations, per direction, may be shown on rural guide signs, with a maximum of four total destinations per sign.

- Do not count route shields and related plaques as a destination.
- Do not consider symbol signs such as airport, train station, watchable wildlife, etc., as a destination.
- Do not consider street name signs (at intersecting streets) as a destination. Separate these by a white line, if the street name is incorporated into the guide sign.

3. The priority of destinations to be shown on intersection guide signs shall be as follows:

- a. Closest major city (population over 50,000).
- b. Closest city or community.
- c. National park, state park, state fairgrounds, public college, or university.
- d. Major traffic generator, publicly owned. \*
- e. Major traffic generator, privately owned. \*
- f. Community college, private college.
- g. County park, fairgrounds.

\*Major traffic generators must meet attendance requirements on page 5-17.

4. Destinations shown on Advance Guide signs shall be consistent with the destinations shown on the Intersection Guide sign.

## **Publicly Owned and Non-Profit Public Agencies**

A publicly owned or non-profit public agencies or operations such as public schools, landmarks, armories, Red Cross centers, unincorporated communities, wildlife refuges and youth camps, permanently located off a highway may be signed using the full name or approved abbreviation.

Signs in this category may be signed on primary and secondary highways (not on freeways) at the closest access point. If distance to the site is more than one mile, the mileage may be added to the legend.

## **Event centers and Stadiums**

Event centers and stadiums such as auditoriums, ball fields, exposition centers, parks, fairgrounds, and race tracks, may be signed on primary and secondary highways at the closest access point. To qualify for signing, there must be a significant activity at least weekly.

## **Public Service Offices**

Public service offices such as the state capitol, state police, public utility commissions, department of Motor Vehicles and department of Environmental Quality and locations may be signed on freeways, primary, and secondary highways.

## **Colleges, Universities and Technical Schools**

Accredited higher education facilities may be signed on freeways and primary or secondary highways. The school pays for the original sign and installation; ODOT installs and maintains.

## **Shopping Centers**

Malls and shopping centers may be signed on freeways and primary or secondary highways under the following conditions:

1. At least 500,000 square feet of usable floor space.
2. At least 18,000 daily vehicle trips (two-way).
3. Contain at least two and preferably three major retail outlets (JCPenney, Sears, etc.).
4. Any required follow-up signing must be in place before highway signing is completed. Written assurance must be provided before highway signing is started.
5. The shopping center operator is responsible for all installation and maintenance costs. ODOT will install and maintain the signs.

## **Business and Industrial Parks**

Business parks may be signed on freeways and primary or secondary highways under the following conditions:

1. At least 500,000 square feet of usable floor space.
2. At least 18,000 daily vehicle trips (two-way).
3. The destination must be within one mile of the exit from the state highway.
4. Any required follow-up signing must be in place before highway signing is completed. Written assurance must be provided before highway signing is started.
5. The business or industrial park operator is responsible for all installation and maintenance costs. ODOT will install and maintain the signs.

## **Recreational-Cultural Interest Area Signs**

### **Federal Parks**

Parks maintained by the federal government may be signed on freeway and primary or secondary highways.

### **State Parks**

If the park is the only destination listed on the freeway sign use the brown recreational guide sign. If the exit leads to other destinations, the park is included on the green destination sign.

### **Resort Areas**

The brown recreational guide sign may be mounted under a guide sign under the following conditions:

1. Resort is in a rural area where the highway is either in a scenic area or passes through public land where normal advertising signs are not allowed. Resorts not in public or scenic areas may be signed under Tourist-Oriented Directional Sign (TODS) Program.
2. Resort must be open full-time throughout the appropriate tourist season and offer at least one significant recreational activity such as swimming, boating, skiing, fishing, hunting, rock hounding. The resort must also offer two of the following services:
  - a. Restaurant.
  - b. Lodging.
  - c. Gasoline and automotive services.
3. The resort area should also be at least 25 miles away from areas offering services of a like nature, to limit unfair competition with like services owned and operated on private land.

When a resort sign is used, a gas symbol sign may be allowed, due to the essential nature of gas in remote rural areas. Gas symbols should only be allowed if a service station is available with continuous operation for 12 hours a day and is located within a complex where other services are available to the traveler (such as food, lodging, or camping). The brown and white symbol sign should be installed under the brown and white resort area sign, with or without other recreational symbol signs.

The use of TODS and logos signs will not be allowed for businesses within resort areas wherever brown and white resort signs (with or without recreational riders) have been provided.

### **General Information Signs (I Series) (MUTCD 2H.02)**

Commercial airports may be signed on freeways and primary and secondary highways if they offer commercial or charter airline service, plane rental, or flying lessons. Use of the horizontal plane symbol sign is preferred over the vertical plane symbol sign.

- Minimum Size 24" x 24".
- Freeway 30" x 30".

The BUS STATION symbol sign (I - 6) may be used on state highways to indicate the location of a bus stop on the state highway. When used, the BUS STATION symbol sign should be accompanied by a supplemental plaque below the sign to identify the bus service that stops there.

The Bus Station/Train Station symbol signs (I-6/I-7), may be used on freeways (symbol only) and primary and secondary highways (symbol with rider) at the appropriate exit or the closest access point. These signs may also be used as trailblazers.

- Minimum Size Symbol 24" x 24".
- Minimum Size Rider 24" x 6".

### **General Service Signs (D9 Series) (MUTCD 2I.02 & 2I.03)**

State and city police, sheriff, DMV, and DEQ are considered motorist services and will be signed under this section with blue background, white legend signs.

General motorist service signs may be appended to interchange guide signs.

Do not use the CHANNEL 9 MONITORED sign on state highways.

NEXT GASOLINE sign may be used on primary and secondary highways at some point leaving the last location where gasoline is available and the next available gasoline is at least 50 miles.

This sign is generic but care should be taken in the placement to avoid it being construed as advertising.

- Minimum Size 36" x 24.

### Emergency Medical Services

All requests for installation of the Emergency Medical Services (EMS) symbol sign shall be submitted to the Health Division of the Oregon Department of Human Resources for certification that the requester satisfies the state's established criteria for facilities included in the EMS system. Under normal conditions, EMS signing is not normally used in conjunction with hospital signing.

- Minimum Size (D9-13 symbol) 24" x 24".

### Tourist Information Centers

Tourist Information Centers may be signed on freeways and primary and secondary highways. The center must have easy, permanent access with adequate parking, where local tourist information is available. An attended facility is not required. See [Information Center Signing Guidelines](#) in this chapter.

### Brake Check Area Signs & Chain-Up Area Signs (D5-13 thru D5-16) (MUTCD 2I.06 & 2I.07)

Due to the limited width of the brake check and chain-up areas and their close proximity to the traveled ways, the Brake Check Area and Chain-up Area series of signs are to remain black legend on yellow background.

The use of warning sign colors gives proper notice to the motorist of the unexpected activities in the area. Design layouts for these signs, as well as for Chain Removal Area signs, are provided with sign details of OW21-4 through OW22-6 in this manual.

### Rural Fire District Signing Guidelines

Rural fire district sign permits may be written using the following criteria:

1. No signs allowed on the interstate system.
2. Fire district must be rural in nature.
3. Signs will be furnished by the fire district.
4. Replacement signs will be furnished by the fire district upon request, or the remaining signs for the fire district will be removed.
5. Signs will be placed outside the normal operating right-of-way (far side of ditch).
6. Signs will be green background, white legend, reflectorized, in accordance with MUTCD Section 2H.02.
7. No logos will be allowed, word message only.

8. 9-1-1 should not appear on the legend as the state of Oregon now has border to border use of this number.
9. Fire district boundary signs should not be required when the boundary is coincident with city or county boundaries.

## General Information

Send all requests for signing resort areas, museums, and golf courses to Travel Information Council (TIC), 1500 Liberty Street SE, Suite 150, Salem, Oregon, 97302. Phone (503) 378-4508.

Send all requests for signing tour or scenic routes to the Oregon Scenic Byway Program, 555 13th Street NE, Salem, OR 97301-3871. Phone (503) 986-4261.

Place community identification signs, as allowed in ORS 377.510, outside of the highway right of way.

## Signing Policy (Specific Service Signs) (MUTCD 2J.11)

The Oregon Travel Information Council (TIC), in conjunction with ODOT, establishes Specific Service (LOGO) sign policy in Oregon, in accordance with ORS 377.805. Direct all requests or inquiries about LOGO signing TIC at (503) 378-4508.

## State Policy (Tourist-Oriented Directional Signs) (MUTCD 2K.07)

The Oregon Travel Information Council (TIC), in conjunction with ODOT, establishes Tourist-Oriented Directional (TODS) sign policy in Oregon, in accordance with ORS 377.805. Direct all requests or inquiries about TODS signing TIC at (503) 378-4508.

## Banners Located on State Highway Right of Way Signing Guidelines

The purpose of these guidelines is to allow for the temporary placement of banners within the state highway right of way to inform the travelling public of local event.

1. Definitions:
  - “Banner(s)” are flags or pennants made of plastic, cloth, or similar material suspended over or spanning the roadway to provide information to motorists on an event occurring in the general area.
  - “Event” is the celebration of a legal holiday, fair, rodeo, roundup, exposition, and other civic event.
2. The district manager may allow for the placement of banners, where the following criteria are met:

- The event is sponsored or endorsed by a city, county, or state agency.
  - The event is two weeks or shorter in duration and open to the general public.
  - The banner contains no more than the name, logo, date, time and general location of the event.
3. The banner(s) and supports must:
    - Be located within a five-mile radius of the event.
    - Have a vertical clearance of at least 20 feet over the roadway and 8 feet over a sidewalk.
    - Be made from a durable material and constructed to withstand wind pressure of 20 pounds per square foot (89N) of exposed surface.
  4. The banner(s) and supports must not:
    - Be placed on an interstate highway.
    - Include any advertising, commercial message, brand or product name, or other information about the event such as cost, directions, or contact information.
    - Interfere with, imitate, or resemble any official traffic control device or attempt or appear to attempt to direct the movement of traffic.
    - Prevent the driver of a motor vehicle from having a clear and unobstructed view of official traffic control devices and approaching or merging traffic.
    - Have any lighting, unless such lighting is shielded to prevent light from being directed at the highway or is of such low intensity or brilliance as not to cause glare or to impair the vision of the driver of a motor vehicle.
    - Be located such that it is a roadside safety or traffic hazard.
    - Be attached to any official sign, post, signal pole, or any other traffic control device or support.
  5. If any banner(s) are allowed, the district manager determines the number and type, the date of installation and removal, and any other conditions necessary to protect the safety of the roadway and motoring public.

## Temporary Event Signing Guidelines

1. Temporary signing on the state highway system may be provided for those activities approximately two weeks or shorter in duration and open to the general public.
2. ODOT reserves the right to limit the number of activities signed per year for each location on the state highway system.

3. Signing on the state highway system normally shall be designed by ODOT. The region traffic engineer must approve signs designed by private parties prior to installation. ODOT shall install and remove all signs on state highway right-of-way.
4. Applicant is responsible for all costs incurred by the state for manufacture of signs, sign supports, labor, and equipment to install and remove signs and for all engineering costs. If the applicant supplies signs to the state, applicant is responsible for all costs incurred by the state for sign supports, labor, and equipment to install and remove signs.
5. Expected attendance of 5,000 or more vehicles on the peak day shall be required for temporary signing on the interstate system and other highways built to interstate standards. Expected daily attendance at locations on other state highways shall be a minimum of 125% of the average daily traffic of the highway being signed to qualify for temporary special event signing.
6. All signing for temporary events must conform to the general requirements of the Manual on Uniform Traffic Control Devices as to location and design.
7. Signing shall not be installed unless adequate follow-up signing to the event, as determined by ODOT, is in place.
8. If the requesting facility meets the minimum standards for a traffic generator, but no destination is available, the facility would be eligible for temporary signing, if space exists (as determined by the region traffic engineer).

## Policy for Private Drive Signs on State Right of Way

Signs for private drives are allowed off state highway right of way. If signs need to be on state right of way to be visible, they can be installed under permit from the district manager. A fee for installation and maintenance of the signs shall be assessed by the district. Our current policy is that in areas where the state right-of-way is excessive (usually 40 or more feet from centerline) or where topography or other conditions restrict the visibility of signs off of the right-of-way, signing for private drives is allowed with some restrictions.

Street name signs (both private and public) must follow minimum standards set forth in the Manual of Uniform Traffic Control Devices (MUTCD) so they appear identical to motorists. However, we do not want motorists, especially trucks, to think a private drive is a public road.

ODOT requires a "PRIVATE DRIVE" (OW14-3) rider to be installed under any sign on ODOT right of way for private driveways.

In order to place a private driveway sign on state right of way, the following sequence needs to be followed:

1. The (appropriate) ODOT region traffic office receives a request for the sign.
2. The region traffic office reviews the requested location to determine if a sign placed off state right of way will be visible to an emergency services vehicle operator.



3. If the sign off state right-of-way would be visible, then the traffic office would deny placement on the state right of way.
4. If the sign off state right-of-way would not be visible, the district manager's office may write a miscellaneous use permit to allow the sign installation with the following stipulations:
  - a. The street name sign has to meet ODOT's specifications.
  - b. A "PRIVATE DRIVE" (OW14-3) rider must be placed under the street name sign.
  - c. The signs must be installed on breakaway posts, per ODOT specifications.
  - d. The requesting party funds the entire sign installation.
  - e. The permit shall specify the maintenance agreement.
5. ODOT requires a determination of need for a STOP sign installation for each installation. If the region traffic manager determines a STOP sign is required, the requesting party will fund the installation.

## Policy on Recreational Symbol Signs on the State Highway System

Recreational symbol signs may be appended to guide signs on the state highway system using the following parameters:

- A limit of four recreational symbol signs may be used for each interchange or each destination.
- The minimum size of recreational symbol signs shall be:
  - 30" x 30" on freeways and expressways.
  - 18" x 18" for all other applications; however, use of larger sizes is recommended.
- Minimum vertical clearance must be maintained, and may require replacement of existing supports, in some circumstances.
- The symbol signs may only be placed at locations where the major guide sign directs traffic to a county, state, or federal park.
  - If other destinations are listed on the guide sign, the park and recreational symbols shall be brown, so as to not be confused with the other destination.
  - If both destinations require a brown background and the symbols do not apply to both destinations, the symbols will not be allowed.
- The Hiking Trails symbol sign (RL-100) may be used on primary and secondary highways at the closest access point, provided the trail is a maintained recreational hiking trail and there is adequate off-highway parking available.

- The Windsurfing symbol sign (RW-210) may be used on primary and secondary highways and may be installed as a rider on freeway interchange guide signs.

The following criteria must be satisfied before recreational symbol signing will be allowed:

1. All signing conforms to the requirements of the MUTCD.
2. The region traffic section must approve the signing, with concurrence from the local agency having jurisdiction over the access to the area.
3. Area must have safe access, adequate parking and restroom facilities for expected attendance.

The requesting agency must purchase the signs, posts (if needed) and sign brackets. The respective district manager determines the cost of the installation.

## Chapter 5B-Freeways and Expressways

### Retroreflection or Illumination (MUTCD 2E.06)

Road name, route shield and mileage signs mounted on overhead roadway structures should not be illuminated. Use ASTM type IX or type XI legend on ASTM type III or IV background sheeting for all new installations.

ASTM type IX or type XI sheeting legend can eliminate the need for illumination on overhead guide sign installations. ODOT will only consider sign lighting when adverse vertical or horizontal alignment requires its use.

### Sign Borders(MUTCD 2E.16)

Border width for guide signs shall be controlled by the legend size and not the board size. Signs having a legend in upper and lower case letters with 10 2/3" or smaller upper case letters and signs having a 12" or smaller all capital lettered legend shall have a 1" border. All signs with a legend larger than as specified above shall have a 2" border.

See Section 2A.14 in the MUTCD for border widths of regulatory and warning signs.

### Overhead Sign Installations (MUTCD 2E.25)

Signs mounted on an overcrossing structure should be limited to 7 feet in overall height.

See [Overhead Sign Installations & Mounting Height in Chapter 2](#) of this document for more information.

## **Interchange Guide Signs (MUTCD 2E.30)**

Each interchange should have a minimum of two guide signs, one advance guide sign and one exit direction sign. In areas where interchanges are closely spaced, intersection sequence series signs may be used in lieu of advance guide signs.

## **Interchange Exit Numbering (MUTCD 2E.31)**

Interchange exit numbers should be installed on all highways built to freeway standards. Exit numbers shall correspond to the mile posting of the highway. Where more than one exit falls within a single milepost, alphabetical suffixes may be used. The gore exit sign shall have the exit number included on the sign. Exit number plaques should be added to the top right-hand edge of the sign for an exit to the right. Exit number signs for left exits shall be placed on the left of the guide sign. See section 2E.31 of the MUTCD for additional requirements on exit numbering.

## **Advance Guide Signs (MUTCD 2E.33)**

For major interchanges two advance guide signs may be used. For intermediate and minor interchanges one advance guide sign should be used.

## **Other Supplemental Guide Signs (MUTCD 2E.35)**

The supplemental guide sign installation, if used, should be erected approximately mid-way between the advance guide sign and the exit direction sign.

## **Post-Interchange Signs (MUTCD 2E.38)**

Where space between interchanges permits, there should be a route marker located 500 feet beyond the end of the acceleration lane, followed by the signs in Table 104.

Table 103: Destinations of Post-Interchange Signs

<b>Sign Type</b>	<b>Placement<sup>2</sup></b>
SPEED XX	Approximately 1000 feet after route marker
Destination and mileage	Approximately 1000 feet previous sign in table
EMERGENCY PARKING ONLY	Approximately 1000 feet previous sign in table
SLOWER TRAFFIC KEEP RIGHT	Approximately 1000 feet previous sign in table

<sup>2</sup> But not more often than once every 5 miles.

## **Weigh Station Signing (MUTCD 2E.54)**

For additional details on the OPEN-CLOSED sign mentioned in Section 2D.49 (MUTCD), see ODOT standard detail DET 4250.

## **General Service Signs (MUTCD 2I.03)**

General Motorist Service panels may be appended to ground-mounted interchange signs.

## **Radio Information Signing (MUTCD 2I.09)**

The CHANNEL 9 MONITORED sign shall not be installed on state highways.

## **Signing Policy (Specific Service Signs) (MUTCD 2J.11)**

The Oregon Travel Information Council (TIC), in conjunction with ODOT, establishes Specific Service (LOGO) sign policy in Oregon, in accordance with ORS 377.805. All requests or inquiries about LOGO signing should be directed to TIC at (503) 378-4508.

## **Historic Trails Signing Guidelines (OI5-1, OI6-1, OI7-1)**

The State Historic Trails Marking Program identifies, for the education and enjoyment of the motoring public, those parts of modern highways that closely parallel historic routes. Meaning the modern route is generally within 5 miles of the historic route, and the two lie within the same geographic feature, such as valley, plateau, etc. In other words, the modern motorist should be able to experience and understand the topography early explorers and immigrants traversed. In cases where the historic route was by water, the waterway must be generally visible from the modern highway.

State or national historic trails may be signed on the state highway system if they have statewide or national significance. Examples include: Oregon Trail (OI7-1), Lewis and Clark Trail (OI5-1) and California Trail (OI6-1).

As a general rule, qualifying segments of highway should be marked about every 10 miles. Whenever possible, attach markers to existing signs.

## **Historic Trail Marking**

Additional signs shall be added immediately below the historic trail logo signs as follows:

1. A sign with the words "INFOCENTER" shall be added to alert the motorist to a Historic Trail kiosk in a rest area or state park.
2. A sign with the words "RIVER ROUTE" shall be added to explain that immigrants used the river in the locality signed.

3. A sign with the words "TRAIL SITE" shall be added to guide the motorist to a trail feature.
4. Additional signs as shown with signs OI5-1 through OI7-11 in this chapter shall be used to guide the motorist when appropriate.
  - a. Custom signs shall be approved by the Region Traffic Section prior to placement.

### Sign Installation Detail Guidelines

Signs installed on the freeway should be mounted on existing sign supports, where possible, preferably at the advance guide sign location. This location gives drivers enough time to decide if they want to leave the freeway for further information about the historic trail.

Signs installed on the freeway are to be 30" x 30" in size. Those installed at ramp terminal intersections to provide turning directions are to be 24" x 24" together with the appropriate directional arrow.

The correct information rider ("Trail Site," "River Route," etc.) should be installed below each size of sign. The information rider should be of the length that will fit the width of whichever trail sign is being used at a particular location. Use the 24" assembly along the state connecting-route leading to the site.

If a county road is involved, encourage the county to install the signs.

### Information Center Signing Guidelines

#### Travel Information Center

These are the gazebo types of information centers operated by the Oregon Travel Information Council, usually found in interstate rest areas. There are some located in other areas (e.g., "D" River Wayside).

##### Freeway –

- Incorporate word message "TRAVEL INFO." or "TRAVEL INFO. CTR." into legend of rest area sign. See figure 101 through figure 103 for sign design examples.

##### Primary/Secondary Highway –

- Use a blue background sign with white lettered legend of "TRAVEL INFORMATION CENTER." Legend may be abbreviated if appropriate.

#### Oregon Welcome Center

These are statewide information centers operated and funded by the Oregon Tourism Commission, doing business as Travel Oregon. The centers are located at select border/entry

points in rest areas, state parks, their own facilities and in Visitor Information Centers operated by local destination marketing organizations.

### Freeway –

- If the facility is in a rest area, incorporate word message “WELCOME CTR.” or “WELCOME CENTER” with the “TOURIST INFORMATION” sign (D9-10) into the legend of rest area sign.
- If the facility is not in a rest area, it is considered to be a motorist service and shall be signed as a rider under one of the guide signs. The rider should incorporate the word message “WELCOME CTR.” or “WELCOME CENTER” with the “TOURIST INFORMATION” sign (D9-10).
- For retro-fits of existing signs, if the distance between the breakaway supports will not accommodate a full length rider as described above, a “TOURIST INFORMATION” sign (D9-10) may be used in conjunction with the “WELCOME CENTER” word message sign (OD9-10a).
- The preferred placement would be under the one mile advance or “EXIT XX” sign.
- See figures 100 through 103 for sign design examples.

### Primary/Secondary Highway –

- The “TOURIST INFORMATION” sign (D9-10) with the “WELCOME CENTER” word message sign (OD9-10a) with appropriate directional arrow auxiliary sign should be used to guide motorists to the center.

## Visitor Information Center

These are information centers usually operated by local and regional destination marketing organizations (DMOs). In specific circumstances, visitor information centers are run by others, on behalf of DMOs, as a public service. In these isolated instances, they are allowed signing if they qualify by:

- Documenting they operate the center on behalf of the DMO.
- Meeting the standards adopted by the Visitor Center Sign Committee, shown in the Visitor Information Center Sign Standards section below.

Prior to replacement of any existing visitor information center signing, ODOT shall request the visitor information center submit documentation to the ODOT district office showing their facility meets the new standard, as shown in the Visitor Information Center Sign Standards section below.

### Freeway –

There are two options for signing visitor information centers on the freeway: through the Travel Information Council (TIC) as an attraction logo; and through ODOT as a motorist service. Only one option shall be installed.

1. A visitor information center in partnership with a private business and qualifies under the definition of Travel Plaza (as authorized in TIC Statute, ORS 377.710) is eligible for a Tourist Attraction Logo sign through TIC. The logo sign shall incorporate the “TOURIST INFORMATION” sign (D9-10) for statewide consistency.
2. A visitor information center that meets the standards shown in the Visitor Information Center Sign Standards section below, and serves a single location as a stand-alone entity is eligible for a motorist service sign through ODOT.
  - The visitor information center shall be signed as a rider under one of the guide signs. The rider shall consist of the word message “VISITOR INFO” or “VISITOR INFORMATION.”
  - For retro-fits of existing signs, if the distance between the breakaway supports will not accommodate a full length rider as described above, a “TOURIST INFORMATION” sign (D9-10) may be used instead.
  - The preferred placement is under the one mile advance or “EXIT XX” sign.
  - See figures 100 through 103 for sign design examples.

### Primary/Secondary Highway –

- The “TOURIST INFORMATION” sign (D9-10) with appropriate Directional Arrow Auxiliary sign should be used to guide motorists to the center.

## Visitor Information Center Sign Standards

In order to qualify for a visitor information center sign, a business must submit to the ODOT district office a letter from the nearest Destination Marketing Organization<sup>3</sup> (DMO) certifying that it meets the following standards.

### Mandatory Standards

Visitor information centers shall have:

1. Plans and procedures to respond to visitor inquiries in a timely manner.
2. Directional signs, as needed, on county or city roads to lead visitors from the first sign to the visitor center.

---

<sup>3</sup> The DMO should be the nearest Convention & Visitors Bureau or Chamber of Commerce. If there is not a CVB or chamber in your city or one that represents your county, then a letter from the Regional Destination Marketing Organization would be accepted.

3. Signs at the building, which are consistent with the official Visitor Information Center signing.
4. Trained staff with destination and customer service expertise to meet the needs of the leisure travel market.
5. Copies of the appropriate and current local visitor information and regional guide on display, and access to guides from the other six regions available on request.
6. Current statewide materials provided by Travel Oregon and the Oregon Department of Transportation available to the public upon request.
7. Open hours: A minimum of five days a week, five hours a day. Hours shall be clearly posted.
8. Access to visitor information after hours (such as brochure racks, information kiosk, phone message board, website address, etc.).
9. ADA accessibility.
10. Automobile parking within walking distance, or easy access by public transportation.
11. Drinking fountain or access to water during open hours.
12. Restrooms within walking distance, accessible to all members of the traveling public during open hours.
13. A landline telephone for staff or guest emergency use.

#### **Voluntary Standards**

Visitor information centers should consider having:

1. Reservation capability.
2. Recreational vehicle parking within walking distance.
3. Access to staff and/or resources with multiple language speaking capabilities.
4. Internet access available (Possibly demonstrated with a Wi-Fi symbol on the sign at the Visitor Information Center).

The Visitor Center Sign Committee developed these standards. The Oregon Traffic Control Devices Committee endorsed the standards, which the state traffic engineer approved on 12/18/2009.

The Visitor Center Sign Committee consists of representatives from the Oregon Department of Transportation, Travel Information Council, Travel Oregon, Oregon Destination Marketing Organizations and Oregon State Chamber of Commerce.



## Alternative Electric Vehicle Charging Symbol Signing Guidelines

An interim approval has been issued for the optional use of a general service symbol sign that provides road users direction to electric vehicle charging facilities that are open to the public.

Jurisdictions using the sign under this interim approval must agree to the following:

- Comply with the technical conditions listed below.
- Supply the Oregon Department of Transportation an inventory list of all locations where these signs are installed.
- Comply with Item D in Paragraph 18 of Section 1A.10 of the 2009 MUTCD, which requires:

“An agreement to restore the site(s) of the interim approval to a condition that complies with the provisions in this Manual within 3 months following the issuance of a Final Rule on this traffic control device; and terminate use of the device or application installed under the interim approval at any time that it determines significant safety concerns are directly or indirectly attributable to the device or application. The FHWA’s Office of Transportation Operations has the right to terminate the interim approval at any time if there is an indication of safety concerns.”

The use of the alternative electric vehicle charging symbol sign is optional. However, if an agency opts to use this sign under FHWA interim approval, the following design and installation requirements shall apply and shall take precedence over any conflicting provisions of the MUTCD.

Installation and use of the alternative electric vehicle charging symbol sign shall conform to the general provisions for general service signs in accordance with MUTCD Chapter 2I.

Agencies may also continue to use ELECTRIC VEHICLE CHARGING (D9-11bP) plaque as an educational message mounted below the alternative electric vehicle charging symbol sign in a directional assembly.

Agencies may use the alternative electric vehicle charging symbol sign in general services (D9-18 Series) guide signs.

### Sign Design and Size

- The design of the alternative electric vehicle charging symbol sign, D9-11b (Alternate), shall be as shown in FHWA Interim Approval (IA-13) Memorandum, dated April 1, 2011. The memorandum and accompanying design can be found at the following site: [http://mutcd.fhwa.dot.gov/res-interim\\_approvals.htm](http://mutcd.fhwa.dot.gov/res-interim_approvals.htm).

- The minimum size of the alternative electric vehicle charging symbol sign shall be 24 inches in width by 24 inches in height.
- The size of the alternative electric vehicle charging symbol sign shall otherwise be in accordance with those of other D9-11 series signs.

Except as otherwise provided above, all other provisions of the MUTCD applicable to signs shall apply to the alternative electric vehicle charging symbol sign.

## Freeway Interchange Guide Sign Guidelines

### 1. Definitions:

**Freeway** – Any state highway with fully controlled access and interchange system or portion of highway with these characteristics, e.g., Sunset Highway.

**Interchange Guide Signs** – Advance and exit directional signs.

**Supplemental Guide Signs** – Guide sign with destination(s) not shown on interchange guide sign.

2. A maximum of two destinations shall be shown in the legend of interchange guide signs. The route number or highway name is not considered to be a destination.
3. The priority of destinations off the freeway shall be as follows.
  - Closest major city (population over 50,000).
  - If the route continues to another major city, that city name should be shown.
  - Name of road crossing freeway.
  - National park, monument, historic site, etc.
  - State park, state fairgrounds, monument, historic site, etc.
  - State college or university.
  - Airport (with commercial passenger service).
  - Major traffic generator, such as large shopping mall or convention center.
  - Community college, private college, trade school with enrollment over 1,000.
  - County park, fairgrounds, monument, historical site, etc.
  - Business or industrial park.
  - Other traffic generator.
4. In the event that the interchange was constructed to provide access to a specific destination, such as the Portland International Airport, or an industrial park, that destination would take priority over those listed above. The second destination on the interchange guide sign

would be determined by the above listed priority. In the legend of the sign itself, the closest destination shall be listed first.

5. One supplemental guide sign with a total of two destinations will be allowed for each exit, providing there is adequate space on the freeway for placement of the sign. The priority for destinations on this sign shall be a continuance of the above listed priority not used on the interchange guide signs.
6. This policy does not refer to motorist service guide signs. They are listed as a separate policy in the MUTCD.

# Criteria for Signing Traffic Generators from Interstate Highways

Table 104: Signing Criteria

Type of Generator	Specific Criteria	Major Metro Area <sup>4</sup>	Urban Area <sup>5</sup>	Rural Area <sup>6</sup>	Sparsely Populated Area <sup>7</sup>
Airports	Regularly Scheduled Commercial Departures Per Day	35	20	15	5
Airports	Distance from Interchange (mi.) <sup>8</sup>	5	7.5	10	10
Colleges and Universities <sup>9</sup>	Total Enrollment, Full and Part-time Students	2,500	2,500	1,000	1,000
Colleges and Universities <sup>9</sup>	Distance from Interchange (mi.) <sup>8</sup>	3	4	5	6
Arenas, Auditoriums, Convention Halls, Stadiums,	Annual Attendance	300,000	250,000	200,000	100,000
State and National Parks	No. of Seats (if applicable)	6,000	5,000	4,000	2,000
Major Recreational Areas (Fairgrounds, Amusement Parks, Zoos, etc.)	Distance from Interchange (mi.) <sup>8</sup>	5	5	5	5
Information Center	Permanent, Easy Access, Adequate Parking	--	--	--	--
Information Center	Distance from Interchange (mi.) <sup>8</sup>	3	3	4	5
Shopping Centers <sup>10</sup> & Industrial Parks	Regional or Statewide Significance; 500,000 Square Feet; 18,000 daily trips	--	--	--	--
Shopping Centers <sup>10</sup> & Industrial Parks	Distance from Interchange (mi.) <sup>8</sup>	1	1	1	1

<sup>4</sup> 50,000 or more population in urban growth boundary.

<sup>5</sup> 5,000 - 49,999 population in urban growth boundary.

<sup>6</sup> County with more than 30,000 populations.

---

<sup>7</sup> County with less than 30,000 populations.

<sup>8</sup> Distance may be increased 0.5 mi. for each 10% over the minimum requirements listed to a maximum of two times the minimum distance listed.

<sup>9</sup> Colleges and universities may also qualify for interstate signing, if they meet the “Annual Attendance” and “No. of Seats” criteria for arenas, auditoriums, etc.

<sup>10</sup> Shopping center must have two or more major retail outlets such as Sears, JCPenney, etc.

# Oregon Guide Sign Details

## OD9-10a

Figure 99: Sign OD9-10a (Welcome Center) Detail

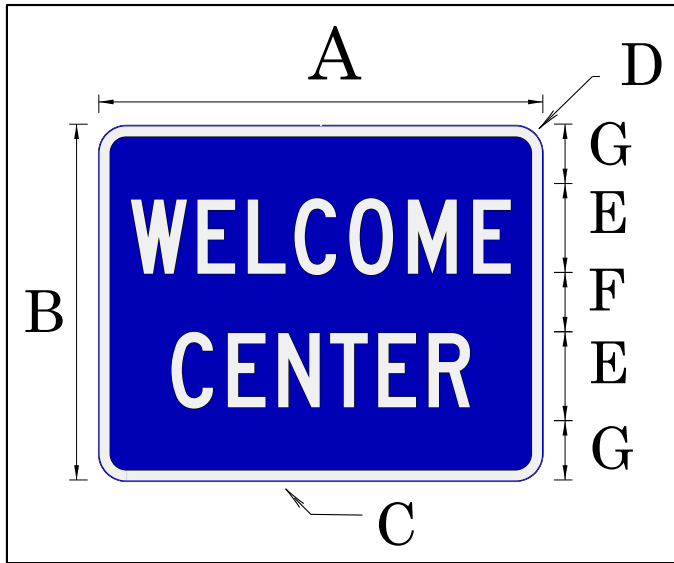

Table 105: Sign OD9-10a (Welcome Center) Dimension (inches)

Sign Size	A	B	C	D	E	F	G
Minimum	24	18	0.5	1.5	4C	3	3.5
Standard	30	24	0.75	1.875	5C	4	5

Sign Background: Blue, standard retroreflective sheeting.

Sign Legend: White, standard retroreflective sheeting.

The WELCOME CENTER word message sign should be used below the TOURIST INFORMATION sign (D9-10) for welcome centers.

The appropriate Directional Arrow Auxiliary sign (M6-1 or M6-3) should be used in the assembly with the same sign background and sign legend color on non-freeway highways to direct traffic.

For additional signing information on Oregon Welcome Centers, see section [Information Center Signing Guidelines in this chapter](#).

The state traffic engineer approved the OD9-10a (Welcome Center) sign in December 2009. The sign was last updated in August 2011.

Figure 100: Typical Freeway Signing when Welcome Center or Information Center is not located in rest area

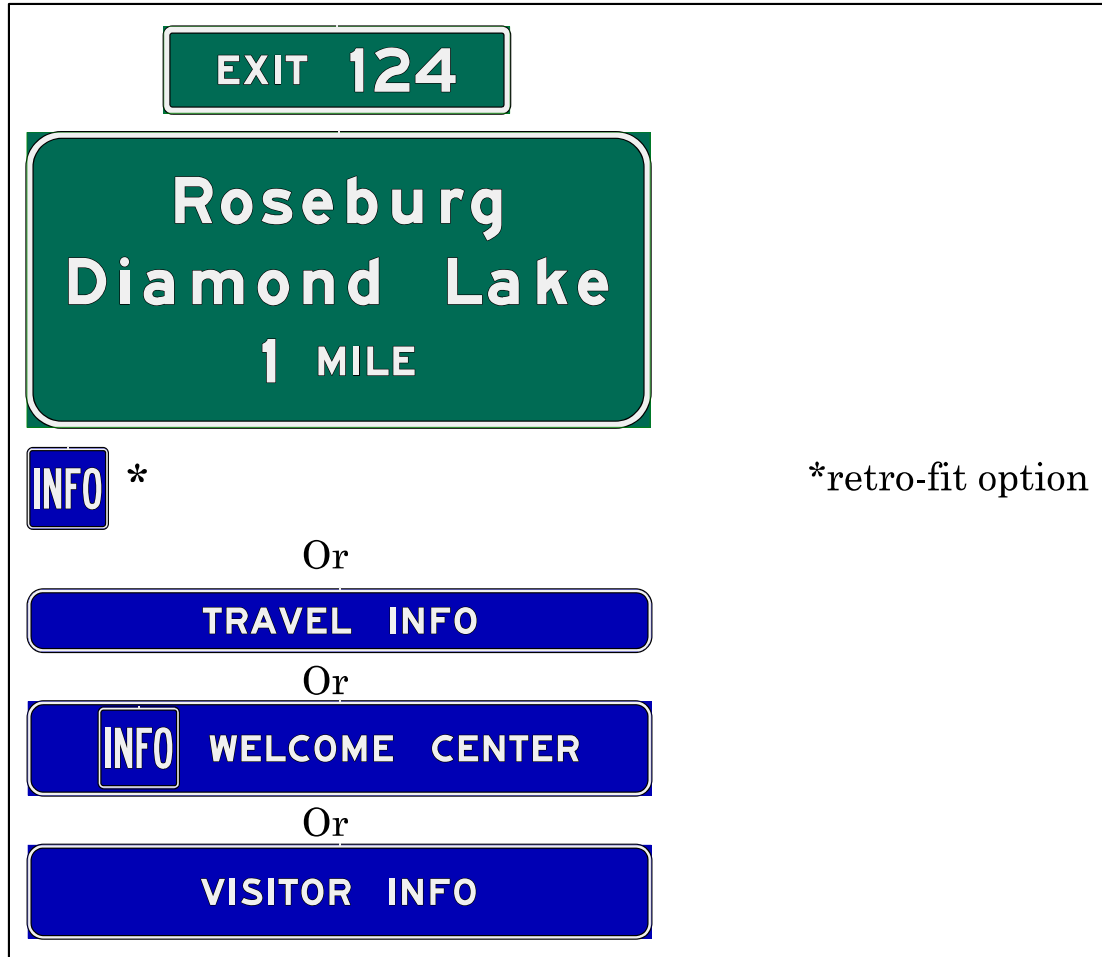

Figure 101: Typical Freeway sign for Travel Info. Center in rest area



Figure 102: Typical Freeway sign for Welcome Center when located in rest area





# OD11-1

Figure 103: Sign OD11-1 (ENTERING WINTER RECREATION AREA PARKING PERMITS REQUIRED IN SNO-PARKS NOV 1 TO APRIL 30) Detail



Table 106: Sign OD11-1 (ENTERING WINTER RECREATION AREA PARKING PERMITS REQUIRED IN SNO-PARKS NOV 1 TO APRIL 30) Dimensions (inches)

A	B	C	D	E	F	G	H	I	J
48	108	80	28	1	2	3C	4	6	6C

Sign Background: White, standard retroreflective sheeting.

Bottom right corner sign background: Brown, standard retroreflective sheeting.

Sign Legend: Brown, standard retroreflective sheeting.

Bottom right corner sign legend: White, Standard Retroreflective Sheeting

The ENTERING WINTER RECREATION AREA PARKING PERMITS REQUIRED IN SNO-PARKS NOV 1 TO APRIL 30 sign shall be installed on the highway at the entrance of designated winter recreation areas.

A series of five signs (OR18-1, OR18-2, OR18-3, OR18-4, and OD11-1) are intended to advise motorists when in winter recreation areas of certain parking restrictions as set forth in ORS 810.170.

The OTC approved the OD11-1 (ENTERING WINTER RECREATION AREA PARKING PERMITS REQUIRED IN SNO-PARKS NOV 1 TO APRIL 30) sign in January 1990. The sign was last updated in July 2008.

**OD11-2**

Figure 104: Sign OD11-2 (SNO-PARK AHEAD 1/4 MILE) Detail



Table 107: Sign OD11-2 (SNO-PARK AHEAD 1/4 MILE) Dimensions (inches)

<b>A</b>	<b>B</b>	<b>C</b>	<b>D</b>	<b>E</b>	<b>F</b>	<b>G</b>
36	48	1	5	6D	4	3

Sign Background: Brown, standard retroreflective sheeting.

Sign Legend: White, standard retroreflective sheeting.

The SNO-PARK AHEAD 1/4 MILE sign shall be installed ¼ mile in advance of designated snow-parking areas.

The OTC approved the OD11-2 (SNO-PARK AHEAD ¼ MILE) sign in January 1990. The sign was last updated in March 1998.

## OD12-1

Figure 105: Sign OD12-1 (PULL OUT) Detail

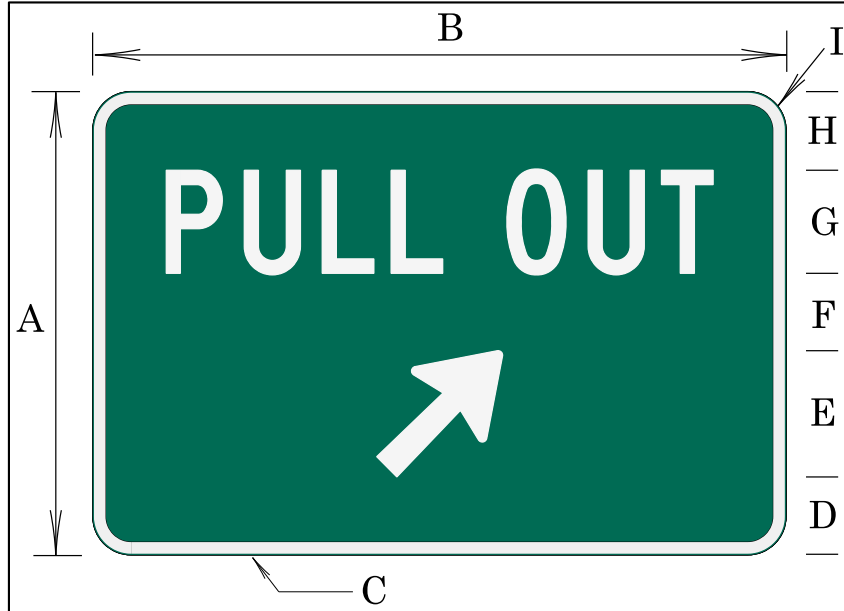

Table 108: Sign OD12-1 (PULL OUT) Dimensions (inches)

A	B	C	D	E	F	G	H	I
36	54	1	5	12.25	4.75	8C	6	3

8"x12" Arrow at 45°

Sign Background: Green, standard retroreflective sheeting.

Sign Legend: White, standard retroreflective sheeting.

The PULL OUT sign may be installed to direct the driver into a shoulder area to allow other traffic to pass or to park. If used, an advance (OD12-2) sign is required.

Criteria for usage:

District selects the areas they would like signed and forwards these locations to the region traffic manager. The region traffic office reviews the sites for the following criteria:

- Adequate hard surface for exit, parking and re-entering the highway.
- Adequate sight distance for recreational vehicles to exit and re-enter roadway.

Region traffic certifies locations to the district, and the district orders and installs the signs.

CC correspondence to traffic HQ so the team can add the signing to our as-constructed plans.

The state traffic engineer approved the OD12-1 (PULL OUT) sign in May 2002.

## OD12-2

Figure 106: Sign OD12-2 (PULL OUT X MILE) Detail

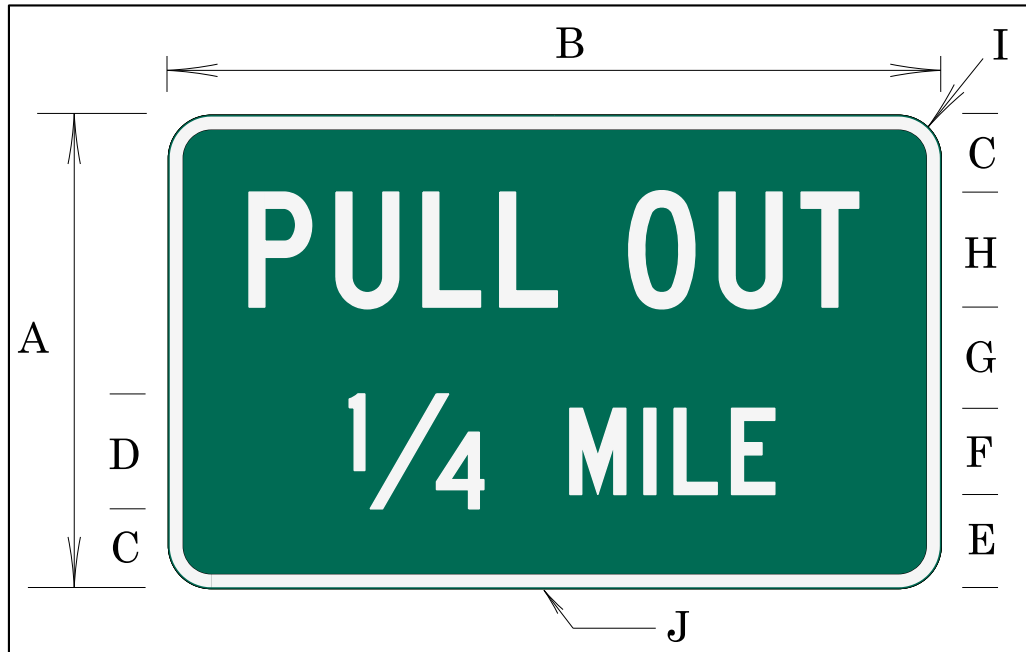

Table 109: Sign OD12-2 (PULL OUT X MILE) Dimensions (inches)

A	B	C	D	E	F	G	H	I	J
33	54	5.75	9	7.25	6C	6	8C	3	1

Sign Background: Green, standard retroreflective sheeting.

Sign Legend: White, standard retroreflective sheeting.

The PULL OUT X MILE sign shall be used in advance of the PULL OUT (OD12-1) sign.

The state traffic engineer approved the OD12-2 (PULL OUT X MILE) sign in May 2002.

# OD-411A

Figure 107: Sign OD-411A (ENTERING XX City) Detail

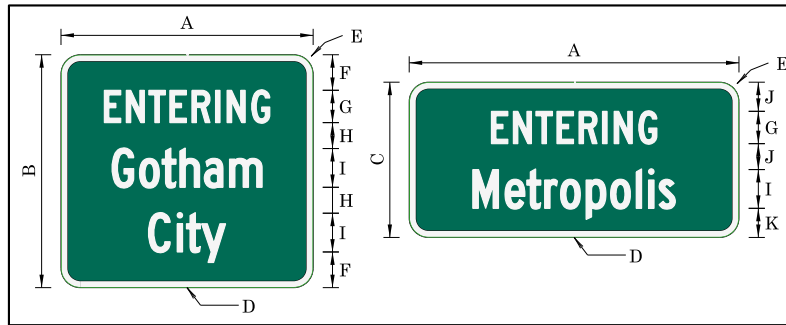

Table 110: Sign OD-411A (ENTERING XX City) Dimensions (inches)

Sign Size	A	B	C	D	E	F	G	H	I	J	K
Standard	VAR.	36	24	1	3	5.5	5C*	4	6C**	4	5
Freeway/ Expressway	VAR.	48	36	1	6	7	6EM*	6	8-6EM**	7	8

\*All Upper Case.

\*\*Standard Sentence Case – First letter upper case only.

Sign Background: Green, standard retroreflective sheeting.

Sign Legend: White, standard retroreflective sheeting.

The ENTERING XX City sign may be used at the entrances to all incorporated cities.

For state highways (non-freeways), a city logo rider (24"x24") may be installed below the ENTERING XX City sign with approval from the state traffic engineer. The city logo shall conform to the criteria outlined for the WELCOME TO XX (OD-413) sign.

Upon approval from the state sign engineer, an additional logo for a recognized statewide or national program (e.g. Tree City USA, Preserve America) or a public college logo located in the city may be installed below the ENTERING XX City sign. Crews may also install a POPULATION sign (OD-413A) below the ENTERING XX City sign. However, no more than two signs may be installed below the ENTERING XX City sign. These signs will be provided by the local agency.

ENTERING CITY signs installed on the interstate highway system shall not have any signs installed below them.

The OTC approved the OD-411A (ENTERING XX City) sign in January 1992. The sign was last updated in July 2014.

# OD-412

Figure 108: Sign OD-412 (ENTERING XX County) Detail

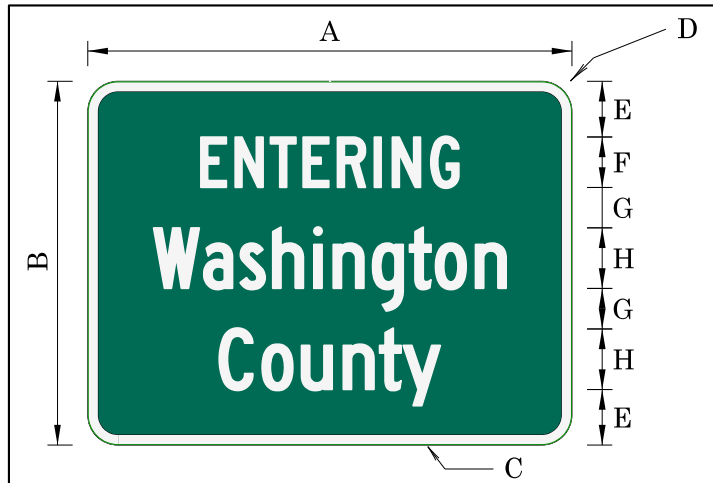

Table 111: Sign OD-412 (ENTERING XX) Dimensions (inches)

Sign Size	A	B	C	D	E	F	G	H
Standard	Var.	36	1	3	5.5	5C*	4	6C**
Freeway/Expressway	Var.	48	1	6	7	6EM*	6	8-6EM**

\*All Upper Case.

\*\*Standard Sentence Case – First letter upper case only.

Sign Background: Green, standard retroreflective sheeting.

Sign Legend: White, standard retroreflective sheeting.

Use the ENTERING XX County sign to indicate county boundaries crossed by state highways. For state highways (non-freeways), a county logo rider (24"x24") may be installed below the ENTERING XX County sign with approval from the state traffic engineer. The county logo shall conform to the criteria outlined for the WELCOME TO XX County sign (OD-414). Upon approval from the state sign engineer, an additional logo for a recognized statewide or national program, or a public college logo located in the county may also be installed below the ENTERING XX County sign. However, no more than two signs shall be installed below the ENTERING XX County sign. These signs will be provided by the local agency.

Do not install any sign below the ENTERING XX County signs installed on the interstate highway system.

The OTC approved the OW-412 (ENTERING XX) sign in January 1990. The sign was last updated in December 2011.

# OD-413

Figure 109: Sign OD-413 (WELCOME TO XX City) Detail



Table 112: Sign OD-413 (WELCOME TO XX City) Dimensions (inches)

A	B	C	D	E	F	G	H	I	J	K
30	3	24	72	3.5	6C	5C	6.5	6	3	1

Sign Background: Green, standard retroreflective sheeting.

Sign Legend: White, standard retroreflective sheeting.

The WELCOME TO XX City sign may be used as a replacement to the ENTERING XX City (OD-411a) sign. Erect the sign on the right-hand side of the roadway at or as near the city limits as practicable. Do not place this sign on the interstate system. Install the city's logo (24"x24") on the face of the sign. The logo shall be furnished by the city. The logo may have different colors and shapes, but should be simple and dignified, devoid of any advertising. For signs placed on state highways, the state traffic engineer must approve the logo used on the sign. The state provides the WELCOME TO XX City sign, if the existing ENTERING XX City sign is due for replacement. If not, the city requesting the sign shall pay total cost of fabrication.

Upon approval from the state sign engineer, an additional logo for a recognized statewide or national program (e.g. Tree City USA, Preserve America) or the logo for a public college located in the city may be installed below the WELCOME TO XX City sign. A POPULATION Sign (OD-413A) may also be installed below the WELCOME TO XX Sign. However, no more than two additional signs shall be installed below the WELCOME TO XX City sign. These signs will be provided by the local agency.

The OTC approved the OD-413 (WELCOME TO XX City) sign in January 1990. The sign was last updated in December 2011.

# OD-413A

Figure 110: Sign OD-413A Detail

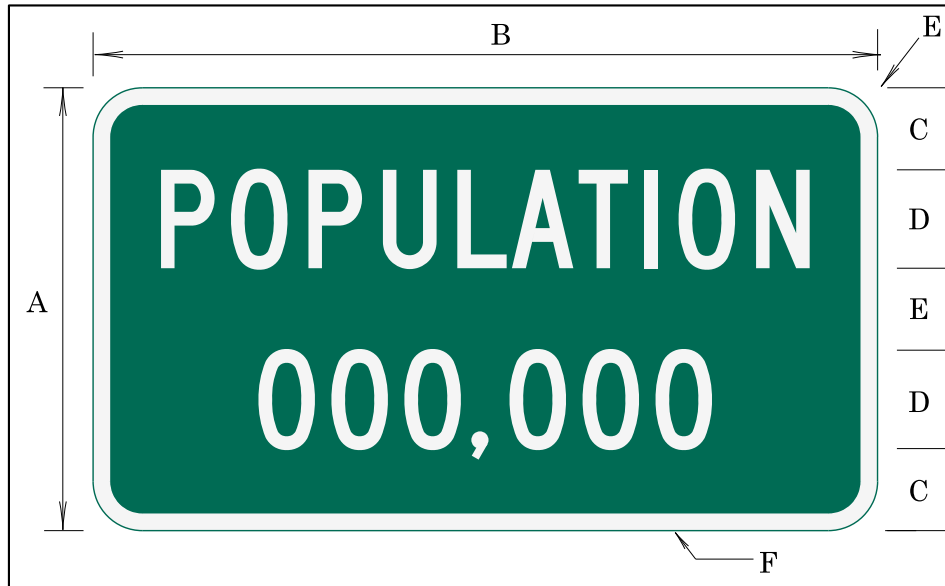

Table 113: Sign OD-413A Dimensions (inches)

A	B	C	D	E	F
18	33	3.5	4C	3	1

Sign Background: Green, standard retroreflective sheeting.

Sign Legend: White, standard retroreflective sheeting.

This sign may be mounted under sign number OD-411A or OD-413. The city involved must fund the manufacture, installation, and maintenance of the sign.

The district manager has the discretion to write a miscellaneous use permit to allow the city to install and maintain the sign.

The population shown on the sign shall be taken from the U.S. Census or State Census Board estimate, whichever is more recent.

The state traffic engineer approved the OD-413A sign in March 1994. The sign was last updated in January 2008.



# OD-414

Figure 111: Sign OD-414 (WELCOME TO XX County) Detail

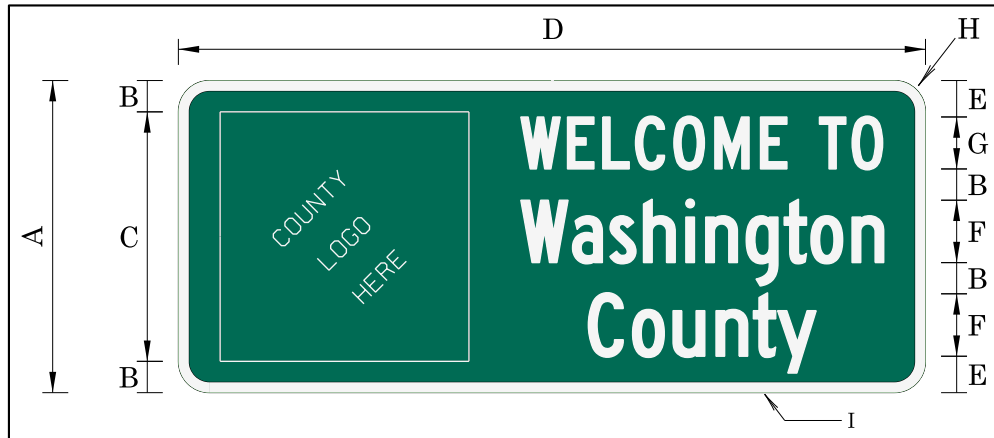

Table 114: Sign OD-414 (WELCOME TO XX County) Dimensions (inches)

A	B	C	D	E	F	G	H	I
30	3	24	72	3.5	6C	5C	3	1

Sign Background: Green, standard retroreflective sheeting.

Sign Legend: White, standard retroreflective sheeting.

The WELCOME TO XX County sign may be used as a replacement to the ENTERING XX County (OD-412) sign. Erect the sign on the right-hand side of the roadway at or as near the county line, as practicable. Do not place this sign on the interstate system.

Install the county's logo (24"x24") on the face of the sign. The logo shall be furnished by the county. The logo may have different colors and shapes, but should be simple and dignified, devoid of any advertising. For signs placed on state highways, the state traffic engineer must approve the logo used on the sign.

The state shall provide the WELCOME TO XX County signs if the existing ENTERING XX County sign is due for replacement. If not, the county requesting the sign pays the total cost of fabrications. Upon approval from the state sign engineer, an additional logo for a recognized statewide or national program or a logo for a public college located within the county may be installed below the WELCOME TO XX County sign. However, no more than two additional signs shall be installed below the WELCOME TO XX County sign. These signs will be provided by the local agency.

The OTC approved the OD-414 (WELCOME TO XX County) sign in January 1990. The sign was last updated in December 2011.

# OD417

Figure 112: Sign OD417 (ADOPT-A HIGHWAY PROGRAM) Detail

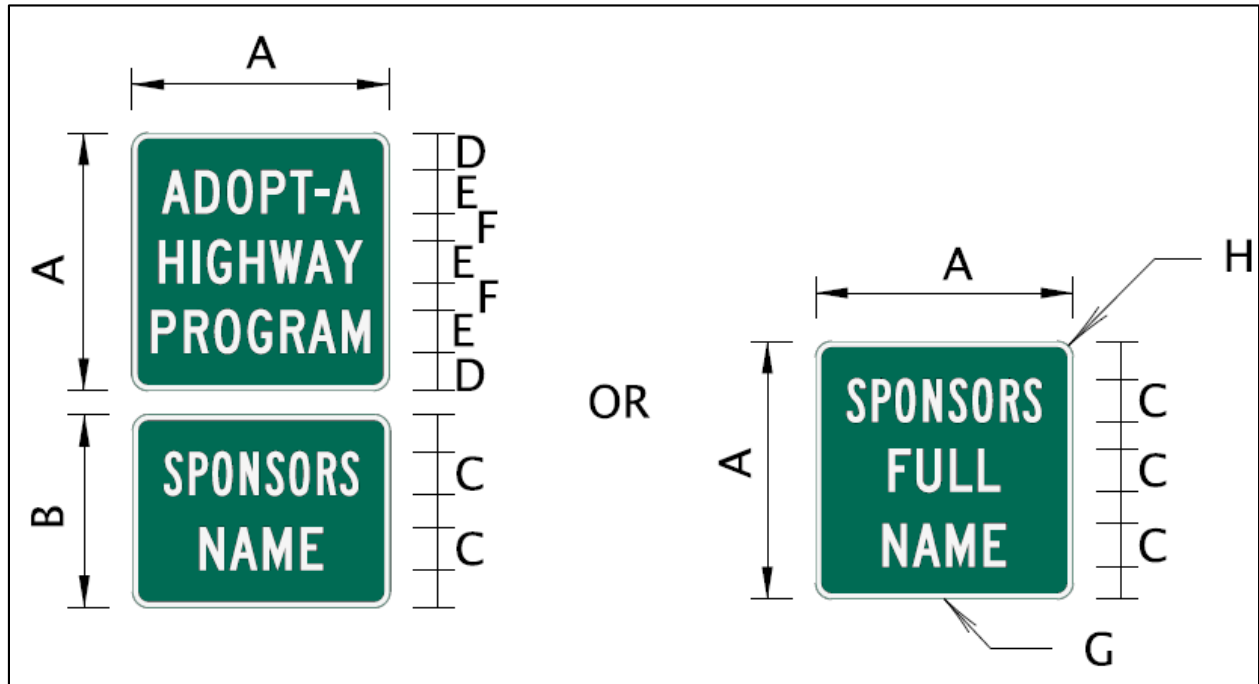

Table 115: Sign OD417 (ADOPT-A HIGHWAY PROGRAM) Dimensions (inches)

A	B	C	D	E	F	G	H
24	18	4B,C or D	3.5	4C	2.5	0.5	1.5

Sign Background: Green, standard retroreflective sheeting.

Sign Legend: White, standard retroreflective sheeting.

The ADOPT-A HIGHWAY PROGRAM and identification rider should be used to denote those sections of highway that have been adopted by agreement.

Use a 24" x 18" rider when the sponsor's name can be shown on one or two lines of legend. If more than two lines are required, then use the 24" x 24" size rider.

The state traffic engineer approved the OD417 (ADOPT-A HIGHWAY PROGRAM) sign in August 1995. The sign was last updated in February 2006.

# OD418

Figure 113: Sign OD418 (ADOPT-A LANDSCAPE PROGRAM) Detail

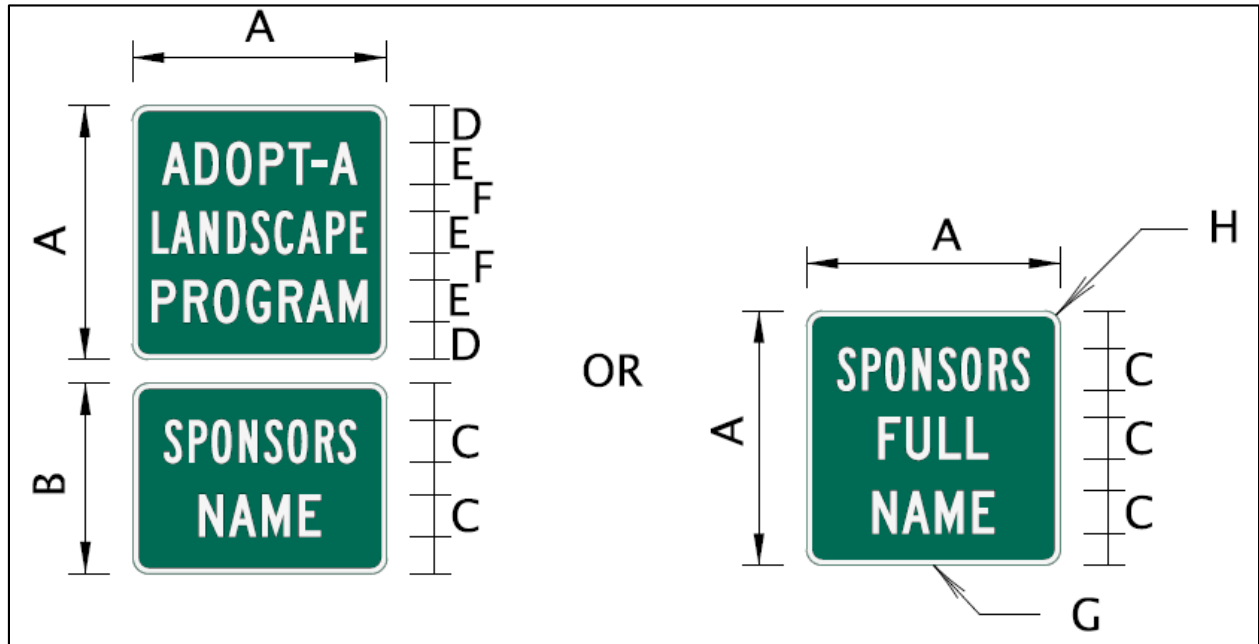

Table 116: Sign OD418 (ADOPT-A LANDSCAPE PROGRAM) Dimensions (inches)

A	B	C	D	E	F	G	H
24	18	4B,C,D	3.5	4C, 4B	2.5	0.5	1.5

Sign Background: Green, standard retroreflective sheeting.

Sign Legend: White, standard retroreflective sheeting.

The ADOPT-A LANDSCAPE PROGRAM and identification rider should be used to denote those sections of highway that have been adopted by agreement. Place the signs are parallel to the flow of traffic.

Use a 24" x 18" rider when the sponsor's name can be shown on one or two lines of legend. If more than two lines are required, then use the 24" x 24" size rider.

The state traffic engineer approved the OR418 (ADOPT-A LANDSCAPE PROGRAM) sign in March 1998. The sign was last updated in February 2006.

# D-424

Figure 114: Sign D-424 (HISTORICAL MARKER AHEAD) Detail

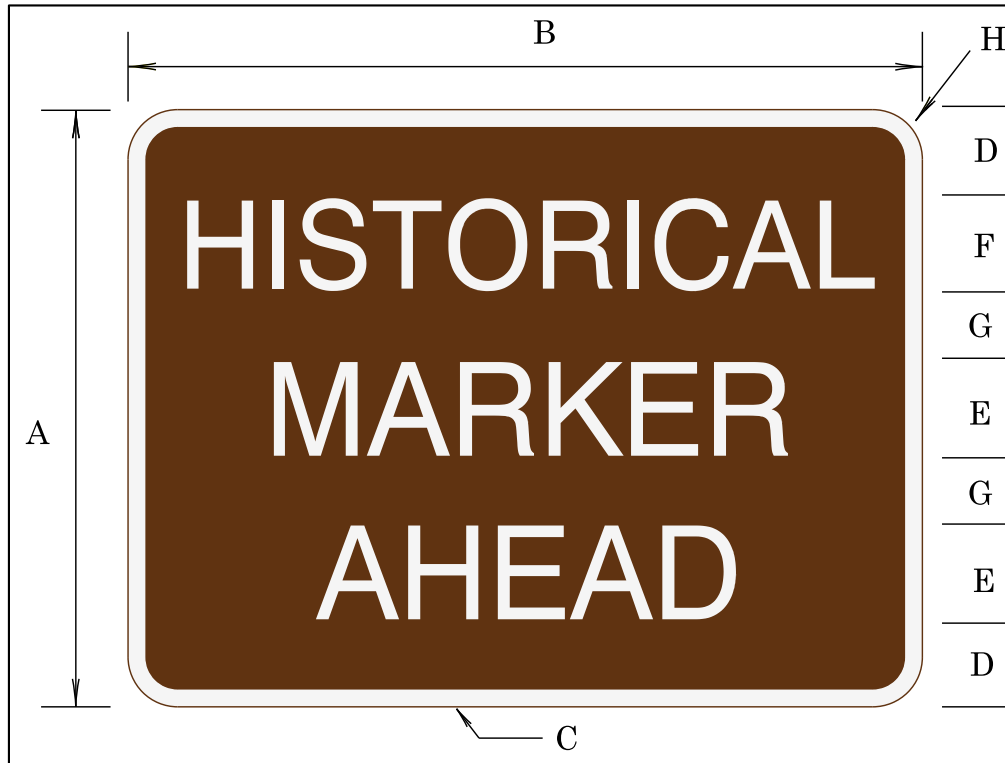

Table 117: Sign D-424 (HISTORICAL MARKER AHEAD) Dimensions (inches)

A	B	C	D	E	F	G	H
36	48	1	5	6D	6C	4	3

Sign Background: Brown, standard retroreflective sheeting.

Sign Legend: White, standard retroreflective sheeting.

The HISTORICAL MARKER AHEAD sign should be installed approximately 1,000 feet in advance of the historical marker.

A NEXT LEFT or NEXT RIGHT syntax may be used to replace AHEAD.

The OTC approved the D-424 (HISTORICAL MARKER AHEAD) sign in June 1991. The sign was last updated in March 1998.

# D-424A

Figure 115: Sign D-424A (GEOLOGICAL MARKER AHEAD) Detail

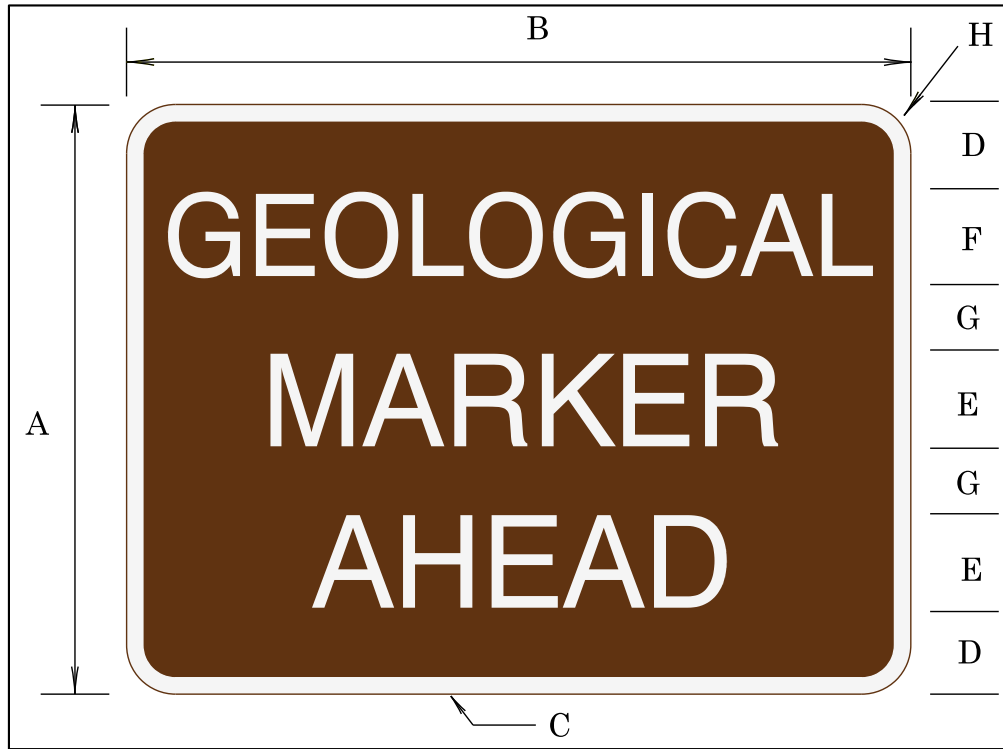

Table 118: Sign D-424A (GEOLOGICAL MARKER AHEAD) Dimensions (inches)

A	B	C	D	E	F	G	H
36	48	1	5	6D	6C	4	3

Sign Background: Brown, standard retroreflective sheeting.

Sign Legend: White, standard retroreflective sheeting.

The GEOLOGICAL MARKER AHEAD sign should be installed approximately 1,000 feet in advance of the geological marker.

A NEXT LEFT or NEXT RIGHT syntax may be used to replace AHEAD.

The OTC approved the D-424A (GEOLOGICAL MARKER AHEAD) sign in June 1990. The sign was last updated in March 1998.

## D-434

Figure 116: Sign D-434 (State Parks Shield) Detail



Sign Background: White, standard retroreflective sheeting.

Sign Legend: Black, blue, and green, standard retroreflective sheeting.

State Parks shield digital .eps files are available through the ODOT state sign engineer. Letters of Public Interest Findings (LPIFs) are no longer required for these signs.

The minimum size for this sign is 33"x36".

The OTC approved the D-434 (State Parks Shield) sign in January 1990. The sign was last updated in December 2011.

## D-435

Figure 117: Sign D-435 Detail

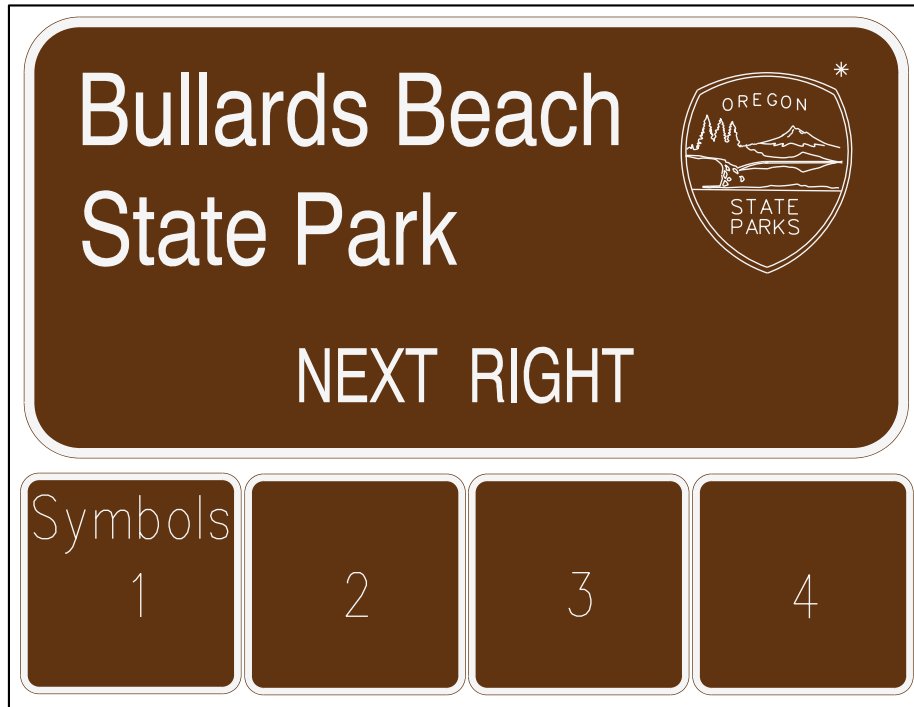

Sign Background: Brown, Standard Retroreflective Sheeting

Sign Legend: White, Standard Retroreflective Sheeting

Advance directional signs for state parks are designed for use at collector points on state highways. They are not to be used at property entrances. Design parameters include:

- Minimum 6 inch letters.
- Minimum 18 inch shield (optional).
- Maximum four recreation symbols.
- Symbols 24" x 24" (min. 18" x 18") inches white on brown as appropriate.

State Parks shields or decals are available through the state sign engineer. Letters of Public Interest Findings (LPIFs) are no longer required for these signs.

The state traffic engineer approved the D-435 sign in May 1997. The sign was last updated in December 2011.

# ORG-010

Figure 118: Sign ORG-010 (Heritage Site) Detail

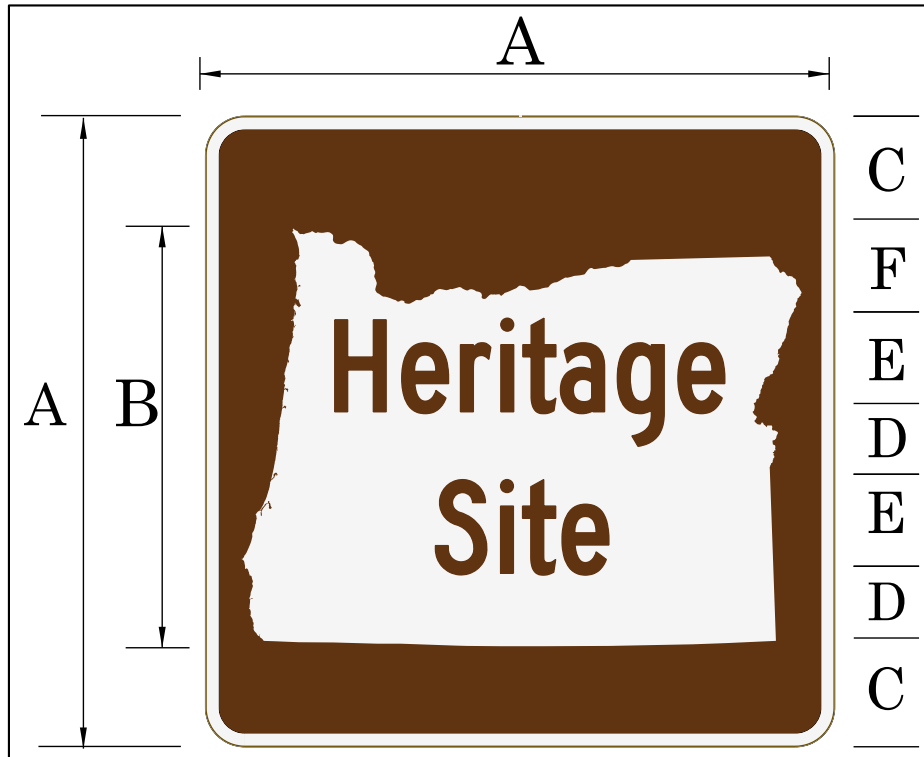

Table 119: Sign ORG-010 (Heritage Site) Dimensions (inches)

A	B	C	D	E	F
24	15.5	4.25	2.5	3.5C	3.5

Sign Background: Brown, standard retroreflective sheeting.

State Symbol Sign Background: White, standard retroreflective sheeting.

Sign Legend: Brown, standard retroreflective sheeting.

Border: White, standard retroreflective sheeting.

The Heritage Site symbol sign shall only be used as part of an Oregon State Park assembly.

This sign is only available from the Oregon Parks and Recreation Department. Please contact their sign coordinator at 503-956-0702 for more information.

The state traffic engineer approved the ORG-010 sign in March 2009.



# D447

Figure 119: Sign D447 (SAFETY CORRIDOR NEXT XX MILES) Detail

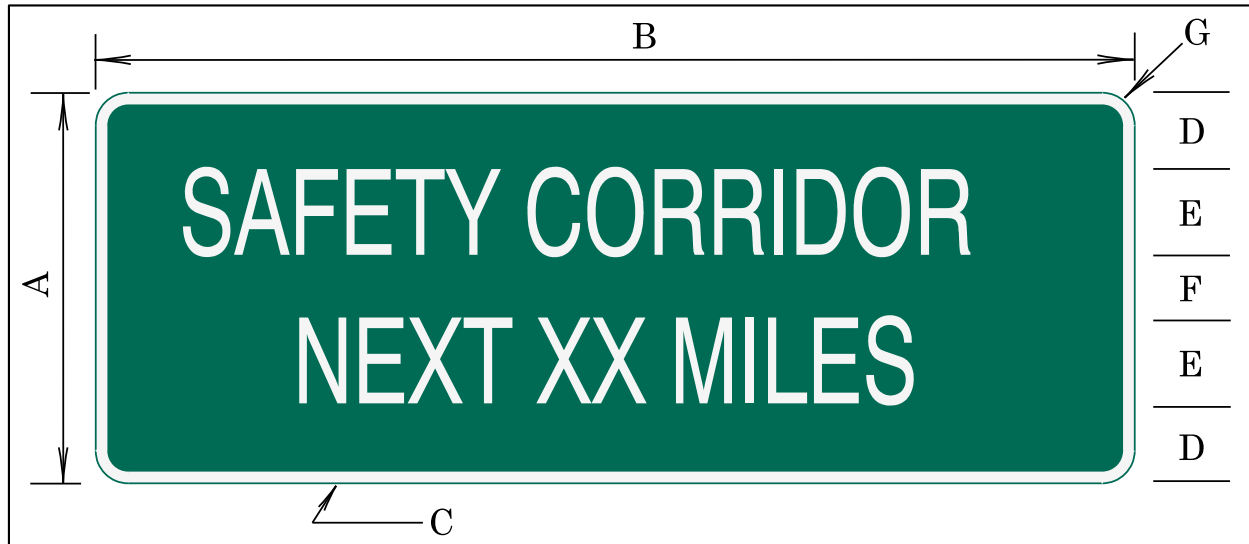

Table 120: Sign D447 (SAFETY CORRIDOR NEXT XX MILES) Dimensions (inches)

A	B	C	D	E	F	G
36	96	1	7	8C	6	3

Sign Background: Green, standard retroreflective sheeting.

Sign Legend: White, standard retroreflective sheeting.

The SAFETY CORRIDOR NEXT XX MILES sign may be installed near the beginning of a section to inform the motorist of the length of the section.

Note: For more information on safety corridors, see the ODOT Traffic Manual.

The state traffic engineer approved the D447 (SAFETY CORRIDOR NEXT XX MILES) sign in March 1994. The sign was last updated in March 1998.

# OD-449

Figure 120: Sign OD-449 (END SAFETY CORRIDOR) Detail

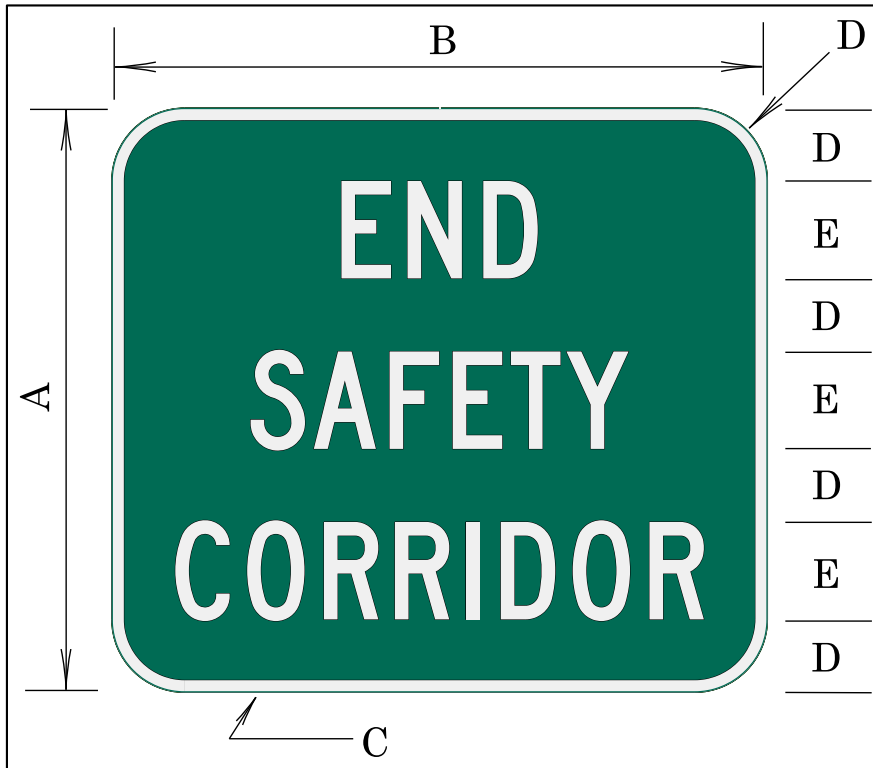

Table 121: Sign OD-449 (END SAFETY CORRIDOR) Dimensions (inches)

A	B	C	D	E
48	54	1	6	8C

Sign Background: Green, standard retroreflective sheeting.

Sign Legend: White, standard retroreflective sheeting.

Install the END SAFETY CORRIDOR sign at the end of a designated safety corridor to inform motorists of the end of the safety corridor.

The state traffic engineer approved the OD-449 (END SAFETY CORRIDOR) sign in February 2007.

# OD450

Figure 121: Sign OD450 (Hydrant Marker) Detail

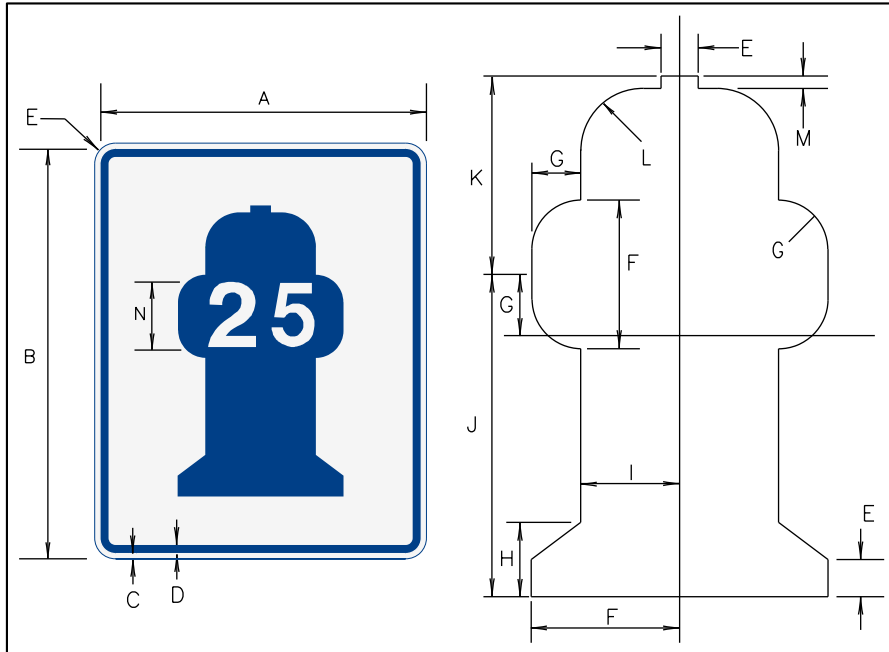

Table 122: Sign OD450 (Hydrant Marker) Dimensions (inches)

A	B	C	D	E	F	G	H	I	J	K	L	M	N	Hole Centers
24	30	0.375	0.625	1.5	6	2	3	4	13	9	2.5	0.5	5C	24

Sign Background: Blue, standard retroreflective sheeting.

Sign Legend: White, standard retroreflective sheeting.

Install Hydrant Markers on limited access highways to assist local fire departments during emergency situations in locating fire hydrants situated outside the right-of-way.

Place the marker parallel to and facing the roadway. Install the marker where visible from the shoulder either on the right-of-way fence or post mounted. The distance indicated on the face of the marker is measured (in feet) from the right-of-way fence to the fire hydrant.

If requested by the fire department, add an additional 24-inch wide plaque below the marker to indicate the street or intersection. If a local fire district provides the signs, ODOT will install them.

The state traffic engineer approved the OD450 (Hydrant Marker) sign in March 1994. The sign was last updated in March 1998.

# OD460

Figure 122: Sign OD460 (WELCOME TO OREGON) Detail



Table 123: Sign OD460 (WELCOME TO OREGON) Dimensions (inches)

Sign Size	A	B	C	D	E	F	G
Minimum	60	45	12	6D	4.5	6E	6
Standard	81	60	16	8D	6	8E	8
Expressway/Freeway	120	90	24	12EM	9	12EM	12

\*Reduce legend spacing 50% on expressway and freeway only.

Sign Background: Green, standard retroreflective sheeting.

State Shape: White, standard retroreflective sheeting.

Sign Legend: Green, standard retroreflective sheeting.

The WELCOME TO OREGON sign should be placed as close to the state border as possible and preferably directly opposite of the OREGON THANKS YOU COME BACK SOON sign.

The state traffic engineer approved the OD460 (WELCOME TO OREGON) sign in March 1994. The sign was last updated in March 1998.

# D461

Figure 123: Sign D461 (OREGON THANKS YOU COME BACK SOON) Detail



Table 124: Sign D461 (OREGON THANKS YOU COME BACK SOON) Dimensions (inches)

Sign Size	A	B	C	D	E	F	G
Minimum	60	45	12	4D	3.5	4	6
Standard	81	60	16	6C	4	5	7
Expressway/Freeway	120	90	24	8EM	6	10	12

\*Reduce legend spacing 50% on expressway and freeway only.

Sign Background: White, standard retroreflective sheeting.

State Shape: Green, standard retroreflective sheeting.

Sign Legend: White, standard retroreflective sheeting.

The OREGON THANKS YOU COME BACK SOON sign should be placed as close to the state border as possible and preferably directly opposite of the WELCOME TO OREGON sign.

The state traffic engineer approved the D461 (OREGON THANKS YOU COME BACK SOON) sign in March 1994. The sign was last updated in March 1998.

**OD-462**

Figure 124: Sign OD-462 (TSUNAMI HAZARD ZONE) Detail

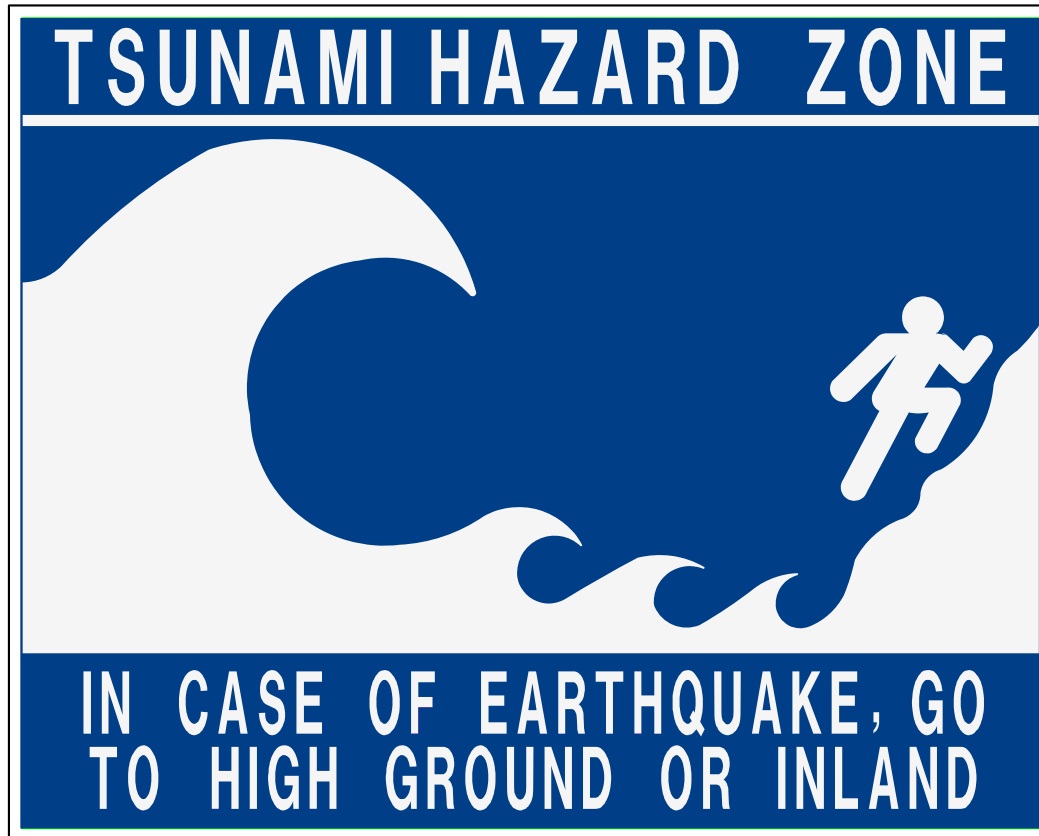

Available in:

- 15"x12"
- 22 "x18"
- 30"x24"

Sign Background: Blue, standard retroreflective sheeting.

Sign Legend: White, standard retroreflective sheeting.

Post the TSUNAMI HAZARD ZONE sign at Pacific coast access points or other low-lying areas that would clearly be vulnerable to a large locally-generated tsunami. Place signs at locations agreed on by local and state governmental authorities.

Delete retroreflective requirements for interpretive signs, signs located indoors, etc.

The state traffic engineer approved the OD-462 (TSUNAMI HAZARD ZONE) sign in March 1994. The sign was last updated in March 1998.

## **OD-464**

Figure 125: Sign OD-464 (EVACUATION SITE) Detail



Minimum size 12" X 15"

Sign Background: White, standard retroreflective sheeting.

Sign Legend: Blue, standard retroreflective sheeting.

Post the EVACUATION SITE sign at the assembly area at the end of the tsunami evacuation route.

The state traffic engineer approved the OD-464 (EVACUATION SITE) sign in September 1999.

# OD-465

Figure 126: Sign OD-465 (ENTERING TSUNAMI HAZARD ZONE) Detail



Table 125: Sign OD-465 (ENTERING TSUNAMI HAZARD ZONE) Dimensions (inches)

A	B	C	D	E	F	G	H
42	48	14.5	5	2.25	3	3.5	1.5

Sign Background: White, standard retroreflective sheeting.

Sign Legend: Blue, standard retroreflective sheeting.

The ENTERING TSUNAMI HAZARD ZONE sign should be used to inform motorists they are entering an inundation zone.

The state traffic engineer approved the OD-465 (ENTERING TSUNAMI HAZARD ZONE) sign in May 2001.



# OD-466

Figure 127: Sign OD-466 (LEAVING TSUNAMI HAZARD ZONE) Detail



Table 126: Sign OD-466 (LEAVING TSUNAMI HAZARD ZONE) Dimension (inches)

A	B	C	D	E	F	G	H
42	48	14.5	5	2.25	3	3.5	1.5

Sign Background: White, standard retroreflective sheeting.

Sign Legend: Blue, standard retroreflective sheeting.

The LEAVING TSUNAMI HAZARD ZONE sign should be used to inform motorists they are leaving an inundation zone.

The state traffic engineer approved the OD-466 (LEAVING TSUNAMI HAZARD ZONE) sign in May 2001.

# 015-1

Figure 128: Sign O15-1 (LEWIS AND CLARK TRAIL) Detail

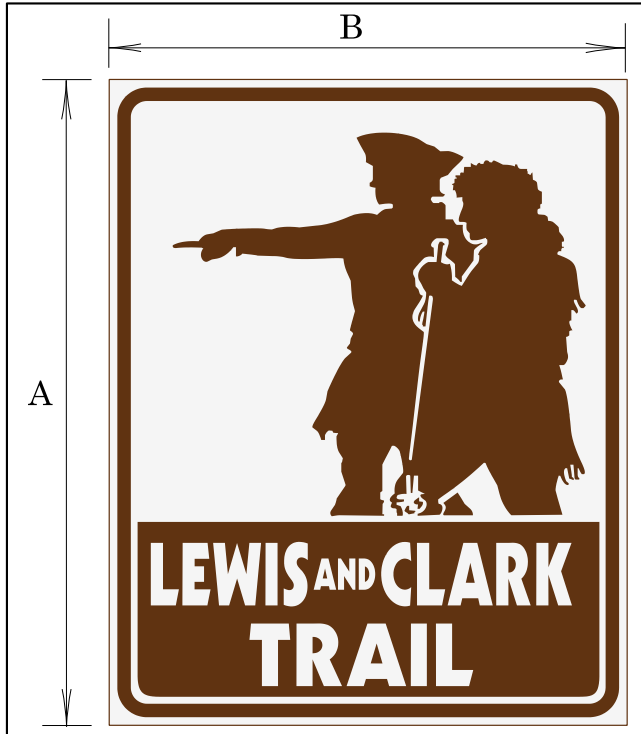

Table 127: Sign O15-1 (LEWIS AND CLARK TRAIL) Dimensions (inches)

<b>A</b>	<b>B</b>
30	24

Sign Background: White, standard retroreflective sheeting.

Sign Legend: White, standard retroreflective sheeting.

Sign Symbols: Brown, standard retroreflective sheeting.

The LEWIS AND CLARK TRAIL symbol and word message signs shall be in accordance with the guidelines listed in section [Historic Trails Signing Guidelines](#) of this chapter.

The OTC approved the O15-1 (LEWIS AND CLARK TRAIL) sign in January 1992. The sign was last updated in February 2006.

## O16-1

Figure 129: Sign O16-1 (CALIFORNIA TRAIL) Detail



24" x 24" Standard

30" x 30" Freeway

Sign Background: White, standard retroreflective sheeting.

Sign Legend:

- Yellow and brown, semi-transparent ink.
- Black, non-reflective sheeting.

The CALIFORNIA TRAIL symbol with Applegate Trail word message signs shall be in accordance with the guidelines listed in [Historic Trails Signing Guidelines](#) of this chapter.

The state traffic engineer approved the O16-1 (CALIFORNIA TRAIL) sign in May 1998.

## 0I7-1

Figure 130: Sign 0I7-1 (OREGON TRAIL) Detail



24" x 24" Standard

30" x 30" Freeway

Sign Background:

- White and brown, standard retroreflective sheeting.
- Yellow, standard retroreflective sheeting (around wagon).

Sign Legend: Black, non-reflective sheeting.

Installation of the OREGON TRAIL symbol and word message signs shall be in accordance with the guidelines listed in [Historic Trails Signing Guidelines](#) of this chapter. Delete brown portion of the sign when installing shield on a guide sign.

The state traffic engineer approved the 0I7-1 (OREGON TRAIL) sign in May 2002. The sign was last updated in February 2006.

# 017-3

Figure 131: Sign O17-3 (TRAIL SITE) Detail

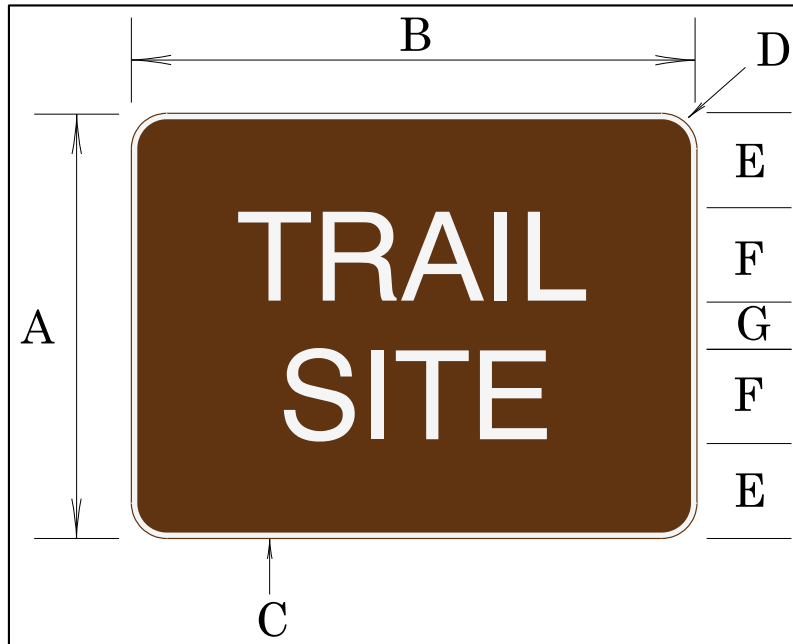

Table 128: Sign O17-3 (TRAIL SITE) Dimensions (inches)

Sign Type	A	B	C	D	E	F	G
Standard	18	24	0.5	1.5	3	5C	2
Freeway	24	30	1	1.5	4	6C	4

Sign Background: Brown, standard retroreflective sheeting.

Sign Legend: White, standard retroreflective sheeting.

Installation of the TRAIL SITE symbol and word message signs shall be in accordance with the guidelines listed in [Historic Trails Signing Guidelines](#) of this chapter.

The state traffic engineer approved the O17-3 (TRAIL SITE) sign in March 1994. The sign was last updated in March 1998.

# 017-4

Figure 132: Sign O17-4 (RIVER ROUTE) Detail

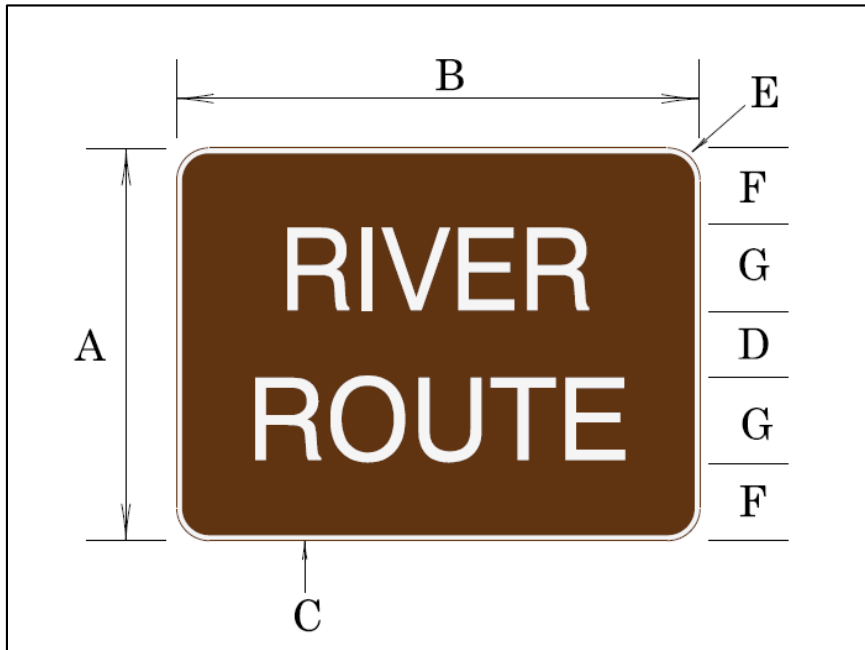

Table 129: Sign O17-4 (RIVER ROUTE) Dimensions (inches)

Sign Type	A	B	C	D	E	F	G
Standard	18	24	0.5	2.25	1.5	2.875	5C
Freeway	24	30	1	4	1.5	4	6C

Sign Background: Brown, standard retroreflective sheeting.

Sign Legend: White, standard retroreflective sheeting.

The installation of the RIVER ROUTE symbol and word message signs shall be in accordance with the guidelines listed in [Historic Trails Signing Guidelines](#) of this chapter.

The OTC approved the O17-4 (RIVER ROUTE) sign in January 1992. The sign was last updated in March 1998.

# 017-4A

Figure 133: Sign OI7-4A (TRAIL ROUTE) Detail

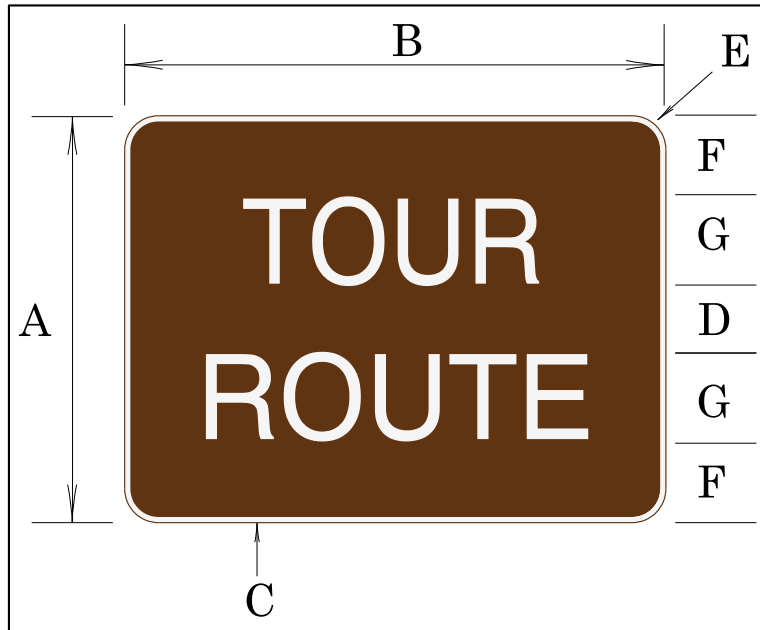

Table 130: Sign OI7-4A (TRAIL ROUTE) Dimensions (inches)

Sign Type	A	B	C	D	E	F	G
Standard	18	24	0.5	2.25	1.5	2.875	5C
Freeway	24	30	1	4	1.5	4	6C

Sign Background: Brown, standard retroreflective sheeting.

Sign Legend: White, standard retroreflective sheeting.

The installation of the TOUR ROUTE symbol and word message signs shall be in accordance with the guidelines listed in [Historic Trails Signing Guidelines](#) of this chapter.

The state traffic engineer approved the OI7-4A (TOUR ROUTE) sign in July 1999.

# 017-6

Figure 134: Sign OI7-6 (BARLOW ROAD ROUTE) Detail

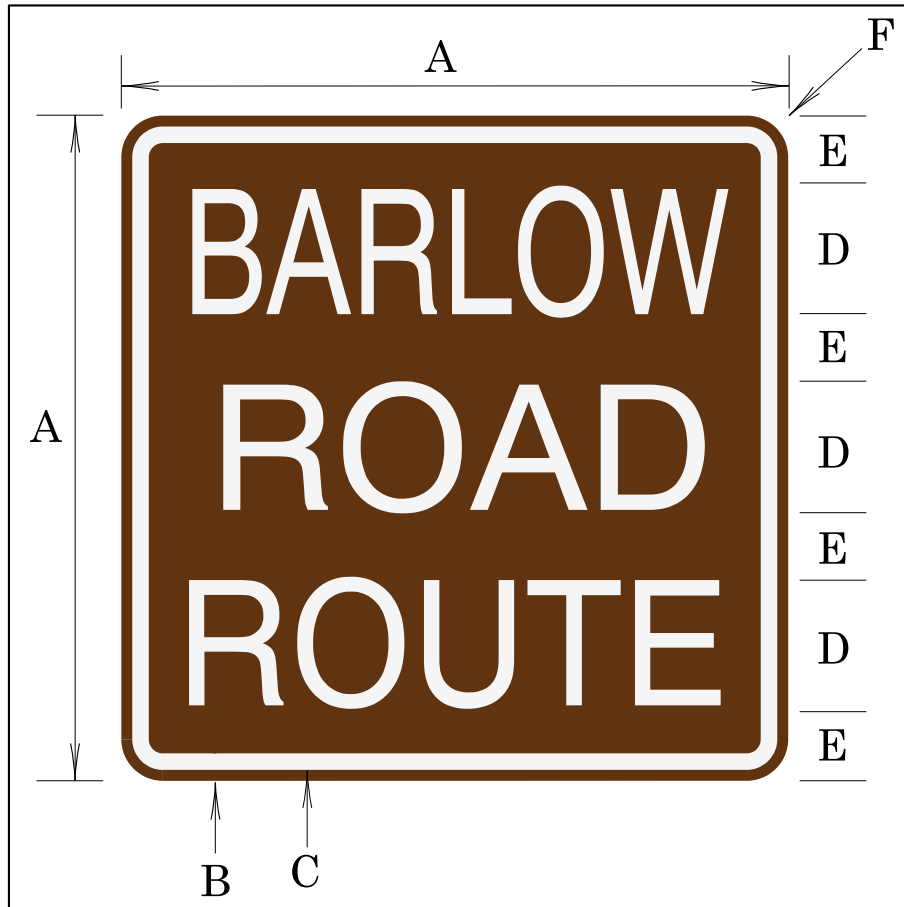

Table 131: Sign OI7-6 (BARLOW ROAD ROUTE) Dimensions (inches)

A	B	C	D	E	F
30	0.375	0.75	6C	3	1.875

Sign Background: Brown, standard retroreflective sheeting.

Sign Legend: White, standard retroreflective sheeting.

Installation of the BARLOW ROAD ROUTE symbol and word message signs shall be in accordance with the guidelines listed in [Historic Trails Signing Guidelines](#) of this chapter.

The OTC approved the OI7-6 (BARLOW ROAD ROUTE) sign in January 1992. The sign was last updated in February 2006.



## 017-8 & 017-9

Figure 135: Sign OI7-8 & OI7-9 (Applegate Trail) Detail

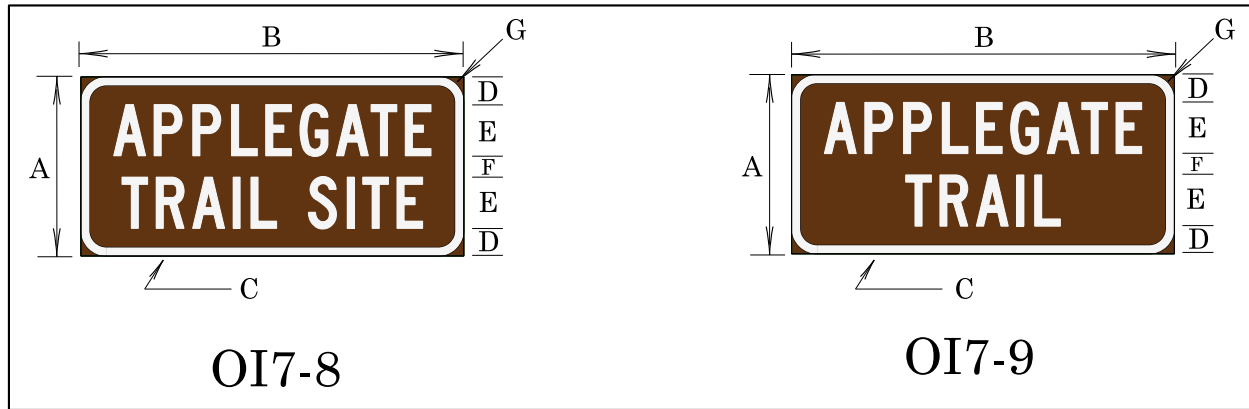

Table 132: Sign OI7-8 & OI7-9 (Applegate Trail) Dimensions (inches)

A	B	C	D	E	F	G
21	45	1	3.25	6C	2.5	3

Sign Background: Brown, standard retroreflective sheeting.

Sign Legend: White, standard retroreflective sheeting.

The installation of the Applegate Trail word message signs shall be in accordance with the guidelines listed in [Historic Trails Signing Guidelines](#) of this chapter.

The state traffic engineer approved the OI7-8 and OI7-9 (Applegate Trail) signs in May 2002. The sign was last updated in February 2006.

## OI7-10 & OI7-11

Figure 136: Sign OI7-10 & OI7-11 (Applegate Trail) Detail

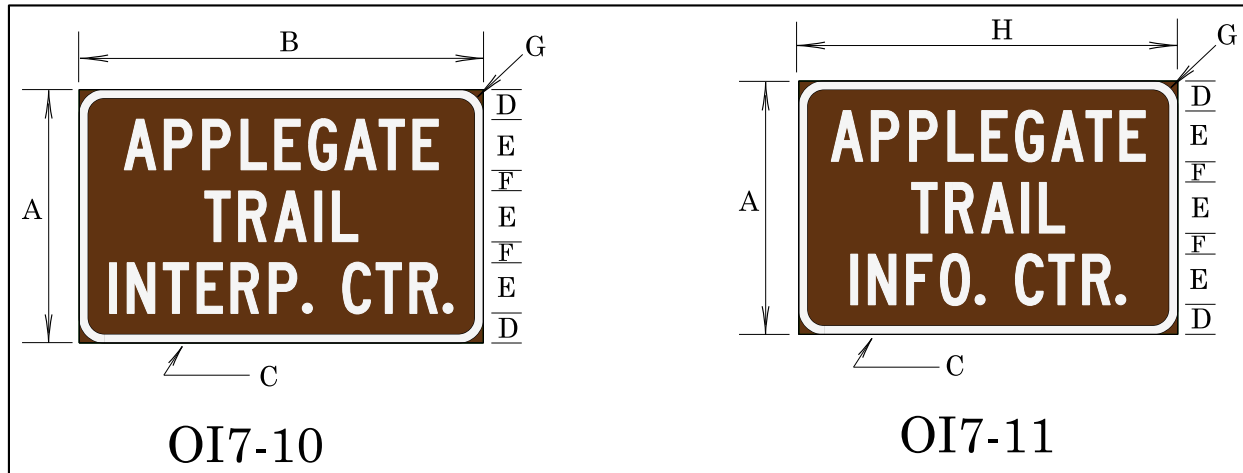

Table 133: Sign OI7-10 & OI7-11 (Applegate Trail) Dimensions (inches)

A	B	C	D	E	F	G	H
30	48	1	3.5	6C	2.5	3	45

Sign Background: Brown, standard retroreflective sheeting.

Sign Legend: White, standard retroreflective sheeting.

The installation of the Applegate Trail word message signs shall be in accordance with the guidelines listed in [Historic Trails Signing Guidelines](#) of this chapter.

The state traffic engineer approved the OI7-10 and OI7-11 (Applegate Trail) signs in May 2002. The sign was last updated in February 2006.

# D-480

Figure 137: Sign D-480 (Entrance Sign) Detail

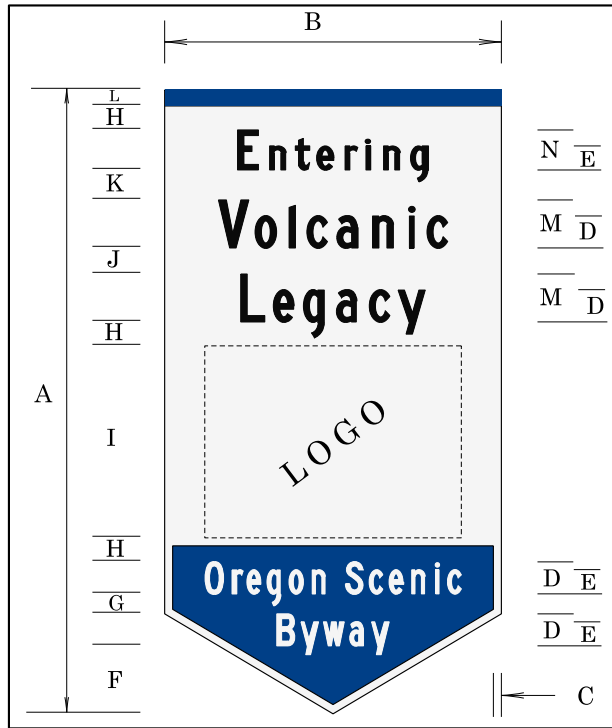

Table 134: Sign D-480 (Entrance Sign) Dimensions (inches)

A	B	C	D	E	F	G	H	I	J	K	L	M	N
78	42	1	4C	3C	8.5	2.5	3	24	3.25	3.75	2	6C	5C

Sign Background:

- White, standard retroreflective sheeting.
- Blue, retroreflective inlay top and bottom.

Upper Sign Legend: Black, non-reflective sheeting.

Lower Sign Legend: White, standard retroreflective sheeting.

Use the entrance sign on state scenic byways approved by the OTC and Oregon Tourism Council. The design shown is for illustration only; actual sign size will vary.

The state traffic engineer approved the D-480 (Entrance sign) sign in June 2001. The sign was last updated in October 2001.

# D-481

Figure 138: Sign D-481 (Exit Sign) Detail

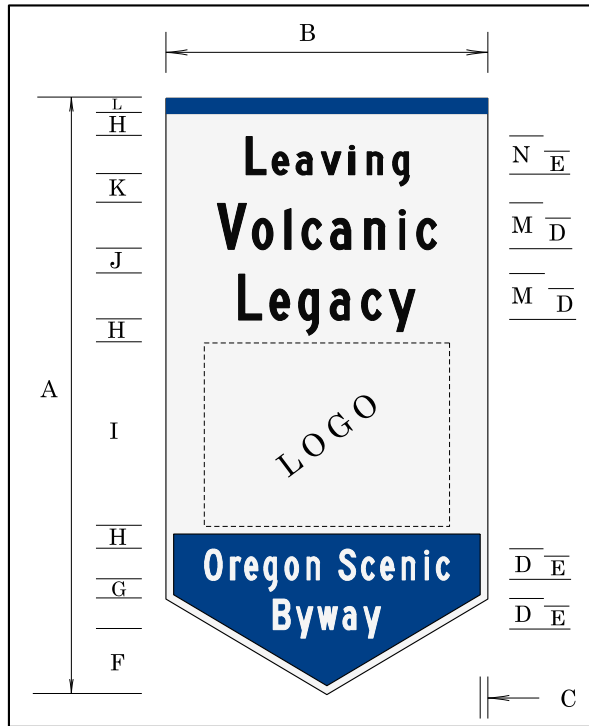

Table 135: D-481 (Exit Sign) Dimensions (inches)

A	B	C	D	E	F	G	H	I	J	K	L	M	N
78	42	1	4C	3C	8.5	2.5	3	24	3.25	3.75	2	6C	5C

Sign Background:

- White, standard retroreflective sheeting.
- Blue, retroreflective inlay top and bottom.

Upper Sign Legend: Black, non-reflective sheeting.

Lower Sign Legend: White, standard retroreflective sheeting.

Use the exit sign on state scenic byways approved by the OTC and Oregon Tourism Council. The design shown is for illustration only; actual sign size will vary.

The state traffic engineer approved the D-481 (Exit sign) sign in June 2001. The sign was last updated in October 2001.

# D-482

Figure 139: Sign D-482 (Trailblazer) Detail

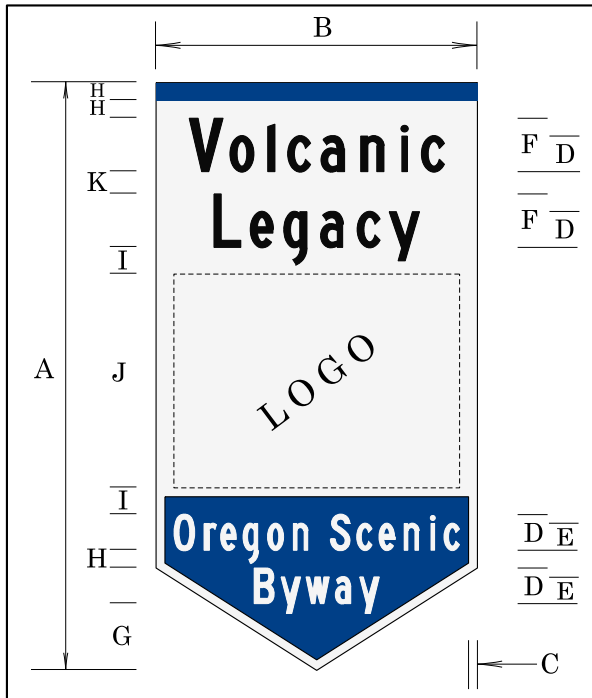

Table 136: Sign D-482 (Trailblazer) Dimensions (inches)

A	B	C	D	E	F	G	H	I	J	K
66	36	1	4C	3C	6C	7.5	2	3	24	2.5

Sign Background:

- White, standard retroreflective sheeting.
- Blue, retroreflective inlay top and bottom.

Upper Sign Legend: Black, non-reflective sheeting.

Lower Sign Legend: White, standard retroreflective sheeting.

Use the trailblazer (confirmation) sign on state scenic byways approved by the OTC and Oregon Tourism Council. The design shown is for illustration only; actual sign size will vary.

The state traffic engineer approved the D-482 (Trailblazer) sign in June 2001. The sign was last updated in October 2001.

# D-483

Figure 140: Sign D-483 (Trailblazer with directional arrow) Detail

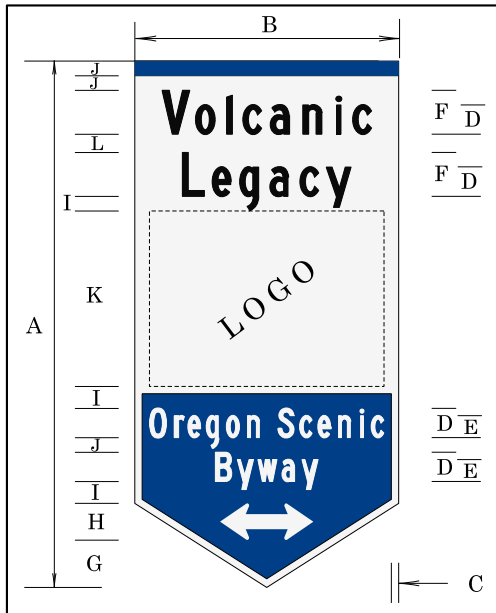

Table 137: Sign D-483 (Trailblazer with directional arrow) Dimensions (inches)

A	B	C	D	E	F	G	H	I	J	K	L
72	36	1	4C	3C	6C	6.5	5	3	2	24	2.5

Sign Background:

- White, standard retroreflective sheeting.
- Blue, retroreflective inlay top and bottom.

Upper Sign Legend: Black, non-reflective sheeting.

Lower Sign Legend: White, standard retroreflective sheeting.

Use the trailblazer with a directional arrow on state scenic byways approved by the OTC and Oregon Tourism Council. The design shown is for illustration only; actual sign size will vary.

The state traffic engineer approved the D-483 (Trailblazer with directional arrow) sign in June 2001. The sign was last updated in October 2001.

# D-484

Figure 141: Sign D-484 (Oregon Tour Route) Detail

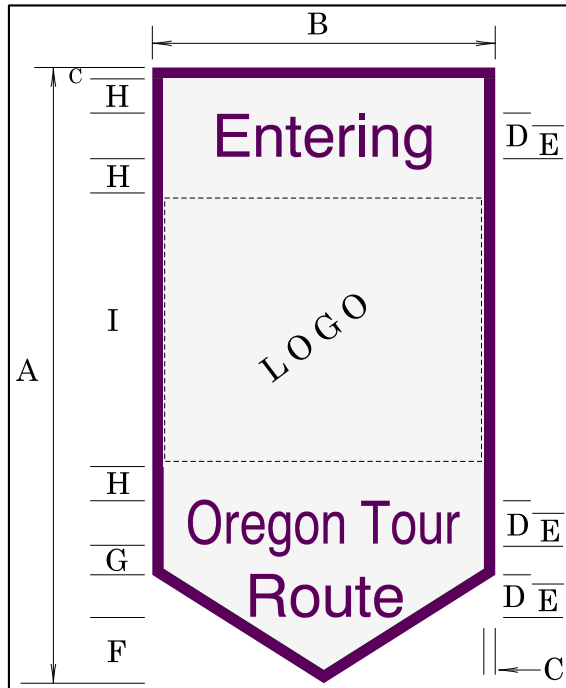

Table 138: Sign D-484 (Oregon Tour Route) Dimensions (inches)

A	B	C	D	E	F	G	H	I
54	30	1	4C	3C	5.5	2.5	3	24

Sign Background: White, standard retroreflective sheeting.

Sign Legend: Plum, standard retroreflective sheeting.

Use the entrance sign on state tour routes approved by the Scenic Byway Committee.

The design shown is for illustration only; actual sign size will vary.

The state traffic engineer approved the D-484 (Oregon Tour Route) sign in February 1997. The sign was last updated in March 1998.

# D-485

Figure 142: Sign D-485 (OREGON HISTORIC ROUTE) Detail



Table 139: Sign D-485 (OREGON HISTORIC ROUTE) Dimensions (inches)

A	B	C	D	E	F	G
48	36	0.5	3	4	5D	24

Sign Background:

- Brown, standard retroreflective sheeting.
- White, standard retroreflective sheeting (shield).

Sign Legend:

- White, standard retroreflective sheeting.
- Black, non-reflective (shield).

The OREGON HISTORIC ROUTE sign may be used to identify a historic route, if designated as such by the OTC per ORS 377.100. ODOT and local agencies with portions of historic routes under their jurisdiction may place these signs if requested.

If the route has an official route designation other than the historic route designation, only use the OREGON HISTORIC ROUTE sign as a supplement to the official route signing. Place the sign staggered in each direction at approximately 10-mile intervals on conventional highways. NOTE: ODOT supplies this sign. It can be purchased from the ODOT Sign Shop.

The state traffic engineer approved the D-485 (OREGON HISTORIC ROUTE) sign in May 2006.



## D-486

Figure 143: Sign D-486 (KEEP OREGON GREEN) Detail



Table 140: Sign D-486 (KEEP OREGON GREEN) Dimensions (inches)

Sign Size	A	B
Standard	36	48
Freeway/Expressway	48	60

Sign Background:

- White, standard retroreflective sheeting.

Sign Legend:

- Green, standard retroreflective sheeting.
- Blue, standard retroreflective sheeting.

The KEEP OREGON GREEN sign may be used to inform motorist of preventing forest fires on our highways. Keep Oregon Green (KOG) provides these signs, in conjunction with Oregon Department of Forestry, 503-945-7498.

Placement and locations of these signs has already been determined in an agreement between KOG and ODOT Traffic-Roadway Section. Any additional sign added to the system shall require state traffic sign engineer’s approval.

The state traffic engineer approved the D-486 (KEEP OREGON GREEN) sign in October 2020.

# **Chapter 6: Construction and Maintenance Signs**

## **Application of Standards**

Many of the warning signs shown in this chapter as construction signs are also shown in chapter 2. Any sign in chapter 2 modified for use in Oregon, is likewise modified in this chapter as well.

### **Flagger Signs (MUTCD 6F.31)**

The BE PREPARED TO STOP sign (W3-4) may be used to warn of stopped traffic caused by a traffic control signal, or in advance of a section of roadway that regularly experiences traffic congestion within a work zone. Place the W3-4 shall be placed in advance of the Flagger Ahead sign (W20-7, W20-7a, CW23-2,) when used.

### **Uneven Lanes Sign (W8-11) (MUTCD 6F.45)**

The UNEVEN LANES sign (W8-11) shall not be used on the state highway system. The ABRUPT EDGE sign (CW21-7) should be used during operations that create a difference in elevation between adjacent lanes open to travel.

### **Reverse Curve Signs (W1-4 Series) (MUTCD 6F.48)**

The Reverse Curve (2 lanes) sign (W1-4bR) and the Reverse Curve (3 lanes) sign (W1-4cR) should be used to warn and guide traffic through a lane shift where the lanes of traffic are maintained.

### **Detour Signs (M4-8, 9 & 10) (MUTCD 6F.49)**

Black on orange W1 series signs, with the detour marker (M4-8) as a rider should be used in place of detour arrow signs to mark the beginning of a detour, if an engineering study determines W1 signs would more accurately depict the actual detour alignment.

Consider using W1 signs when the detour makes a minor or gradual deviation from the normal roadway. ROAD CLOSED signs, as shown in the MUTCD, may not be appropriate under these circumstances.

### **Work Duration (MUTCD 6G.02)**

Portable sign supports should be used for work that occupies a location for up to 72 consecutive hours. Longer duration may be allowed with an approved, project-specific traffic control plan.

## General (MUTCD 6I.01)

Warning and guide signs used for temporary traffic control (TTC) traffic incident management situations may have a black legend and border on a fluorescent pink background.

## Roll-Up Signs

Roll-up signs may be used for any sign type in accordance with the following, unless otherwise stated.

- ODOT Sign Policy & Guidelines.
- Oregon Standard Specifications for Construction.
- ODOT Qualified Products List.
- MUTCD.

Roll-up signs may be used when signs are needed at a single location for no more than 48 consecutive hours. Remove roll-up signs from the road at the end of each work shift when the condition is no longer in effect. When a crew uses roll-up signs with a single lane of traffic, one sign mounted on the right side of traffic is sufficient. When used with two or more lanes going in the same direction, roll-up signs should be used on both the left and right sides of traffic. Roll-up signs should not be mounted to vehicles.

## Business Access Signs in Construction Projects

Construction work may impact access to businesses. When business accesses is severed, relocated or adversely affected during construction, crews may install temporary blue/white motorist services signs to better delineate the access.

Use the following guidance to determine the design and placement for temporary “BUSINESS ACCESS” (CG20-11) signing:

1. Investigate the project site to determine the number and location of accesses, proximity of business frontages to the roadway, and the presence of existing business signing. Based on the guidance below, project development teams should discuss their strategy for determining the need and placement of the signs.
2. If a single business access is affected, a “BUSINESS ACCESS” sign may be used. A directional arrow rider may be added to indicate the direction to the business, depending on the severity of the impact to the access.
3. If several businesses and accesses are affected over an extended section of roadway, consider the following signing strategies:
  - a. Individual access to a single business: Sign with a single “BUSINESS ACCESS” sign.

- i. A rider may be installed below the “BUSINESS ACCESS” sign and include a maximum of three generic business descriptions: “GAS,” “FOOD” and/or “LODGING.” Under special circumstances, where the above descriptions do not apply, crews may use other generic descriptions – e.g. “POST OFFICE,” “GROCERIES,” “THEATRE,” “SHOPPING MALL.”
  - b. Individual access to multiple businesses may be signed with a single “BUSINESS ACCESS” sign.
    - i. As necessary, riders with a maximum of three generic business descriptions may be added – See item 3a above.
  - c. For multiple accesses along sections of roadway for more than ¼ mile, where accesses are less than 100 feet apart (e.g. dense urban or suburban arterials), consider the following strategy:
    - i. Install a modified CG20-11 sign reading “BUSINESS ACCESSES” at the first access point.
    - ii. Delineate all affected access radii with blue plastic tubular markers.
    - iii. Install “BUSINESS ACCESSES” reminder signs on 650-foot intervals through affected areas.
4. Riders shall use 4-inch, type B 2000 or C 2000 font.
5. Limit generic business descriptions to a maximum of two words (e.g. “POST OFFICE”).
6. “BUSINESS ACCESS” signs or riders shall not identify specific business names (e.g. Chevron, Burger King, Fred Meyer, Woodburn Factory Stores, and Washington square).
7. Place the “BUSINESS ACCESS” sign on a single-post temporary sign support at the access point. Crews may use existing posts or supports, but the respective agency or owner must pre-approve.
8. Use blue plastic tubular markers with blue reflective bands to delineate the radii for all affected business accesses.
9. Remove the signs as soon as the permanent access is restored.

# Oregon Construction Sign Details

## CG20-1

Figure 144: Sign CG20-1 (ROAD WORK NEXT XX MILES) Detail

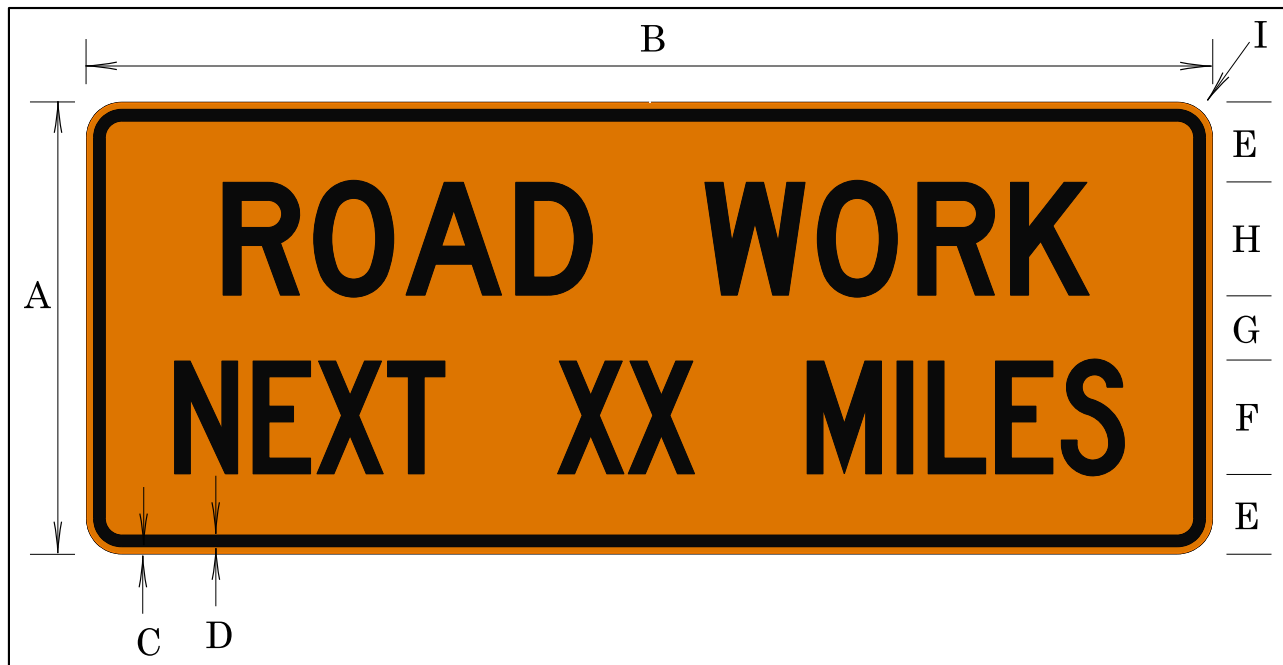

Table 141: Sign CG20-1 (ROAD WORK NEXT XX MILES) Dimensions (inches)

A	B	C	D	E	F	G	H	I
24	60	0.375	0.625	4.25	6C	3.5	6D	1.5

Sign Background: Fluorescent orange, standard retroreflective sheeting.

Sign Legend: Black, non-reflective sheeting.

The ROAD WORK NEXT XX MILES sign should be erected in advance of any temporary traffic control zone of more than two miles in length. The distance shall be stated using the nearest whole mile.

The MUTCD G20-1 sign may be used on low speed roads or off the state highway system.

The state traffic engineer approved the CG20-1 (ROAD WORK NEXT XX MILES) sign in May 1995. The sign was last updated in July 2014.

# CG20-2A

Figure 145: Sign CG20-2A (END ROAD WORK) Detail

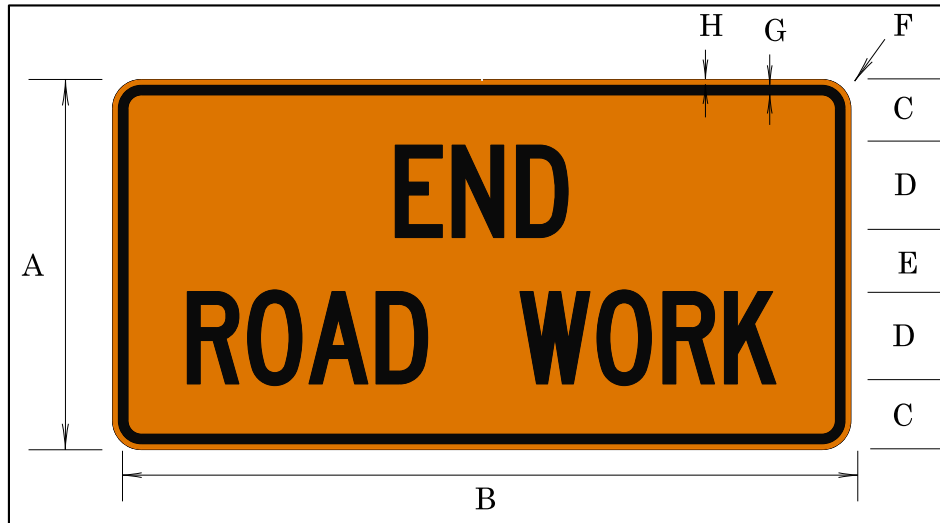

Table 142: Sign CG20-2A (END ROAD WORK) Dimensions (inches)

A	B	C	D	E	F	G	H
24	48	4.25	6C	3.5	1.5	0.625	0.375

Sign Background: Fluorescent orange, standard retroreflective sheeting.

Sign Legend: Black, non-reflective sheeting.

The END ROAD WORK sign should be erected approximately 500 feet beyond the end of the work area.

The MUTCD G20-2 sign may be used on low speed roads or off the state highway system.

The state traffic engineer approved the CG20-2A (END ROAD WORK) sign in May 1995. The sign was last updated in July 2014.

## CG20-5

Figure 146: Sign CG20-5 (END DETOUR) Detail

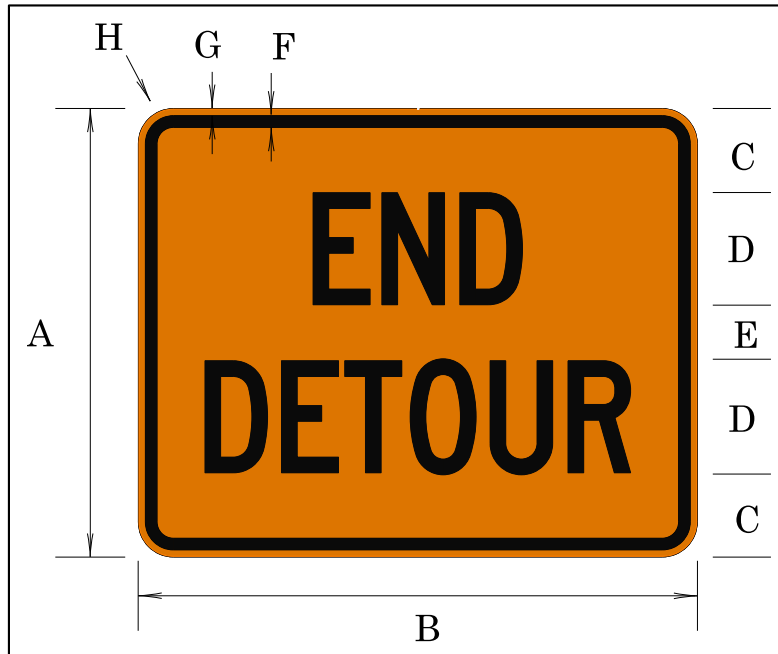

Table 143: Sign CG20-5 (END DETOUR) Dimensions (inches)

A	B	C	D	E	F	G	H
24	30	4.5	6C	3	0.625	0.375	1.5

Sign Background: Fluorescent orange, standard retroreflective sheeting.

Sign Legend: Black, non-reflective sheeting.

The END DETOUR sign should be used to inform motorists the detour has ended.

The MUTCD M4-8a sign may be used on low speed roads or off the state highway system.

The OTC approved the CG20-5 (END DETOUR) sign in June 1990. The sign was last updated in July 2014.

# CG20-6

Figure 147: Sign CG20-6 (DETOUR) Detail

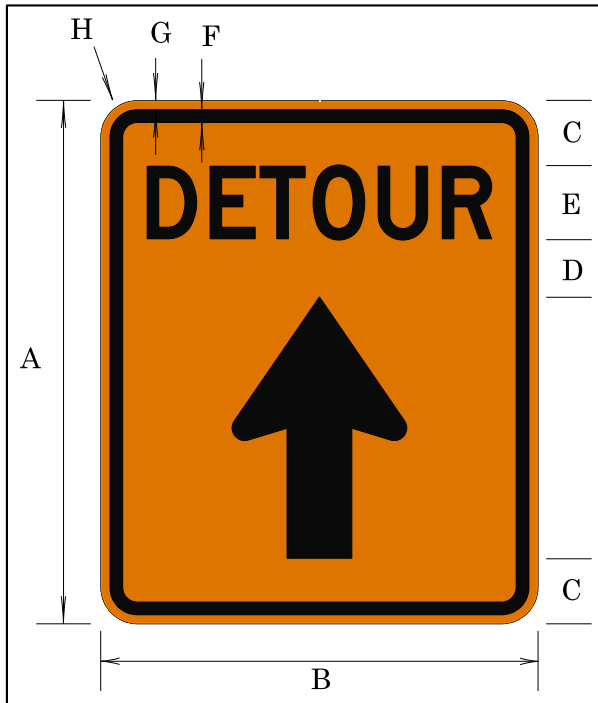

Table 144: Sign CG20-6 (DETOUR) Dimensions (inches)

A	B	C	D	E	F	G	H
36	30	4.5	4	5D	0.875	0.625	1.875

18" x 12" Arrow

Sign Background: Fluorescent orange, standard retroreflective sheeting.

Sign Legend: Black, non-reflective sheeting.

The DETOUR with vertical arrow sign may be used to guide the motorist through a detour. Only use this sign where extra guidance is required.

The OTC approved the CG20-6 (DETOUR) sign in January 1992. The sign was last updated in July 2014.



# CG20-8

Figure 148: Sign CG20-8 (Project Identification) Detail

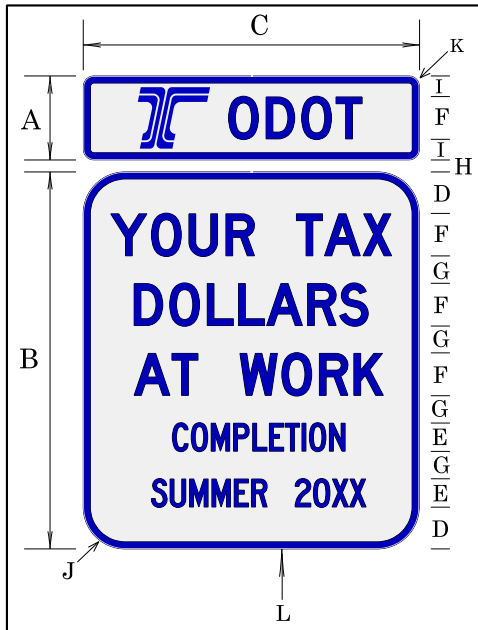

Table 145: Sign CG20-8 (Project Identification) Dimensions (inches)

A	B	C	D	E	F	G	H	I	J	K	L
12	54	48	6	6C	6D	4	2	3	6	1.5	1

Sign Background: White, standard retroreflective sheeting.

Sign Legend: Blue, standard retroreflective sheeting.

The Project Identification sign shall be used to identify ODOT construction projects meeting any of the following criteria:

- Project is on a freeway.
- Project duration is longer than one year.
- Engineer's estimate is \$5 million or more.
- Other high-profile projects as determined by the region.

Additional funding partners may be added with a revised sign design.

The state traffic engineer approved the CG20-8 (Project Identification) sign in July 1999. The sign was last updated in January 2016.

# CG20-10

Figure 149: Sign CG20-10 (EROSION CONCERNS) Detail

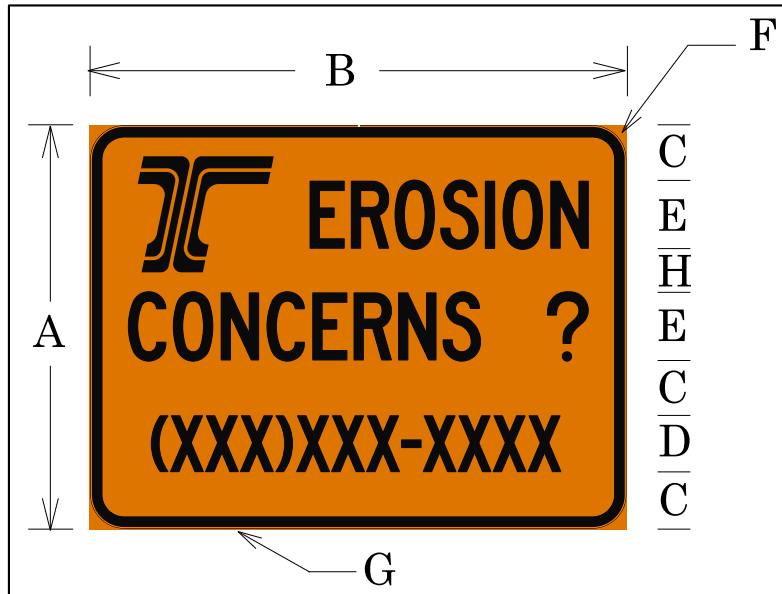

Table 146: Sign CG20-10 (EROSION CONCERNS) Dimensions (inches)

A	B	C	D	E	F	G
18	24	2.5	2.5C	3C	1.5	0.5

Sign Background: Fluorescent orange, non-reflective sheeting.

Sign Legend: Black, non-reflective sheeting.

The EROSION CONCERNS sign may be used on any construction project to provide a phone number to pedestrians so they can voice their concerns. The use of a phone number shall be in compliance of MUTCD guidance of section 2A.06 paragraph 16.

The state traffic engineer approved the CG20-10 (EROSION CONCERNS) sign in July 2001. The sign was last updated in July 2014.

# CG20-11

Figure 150: Sign CG20-11 (BUSINESS ACCESS) Detail

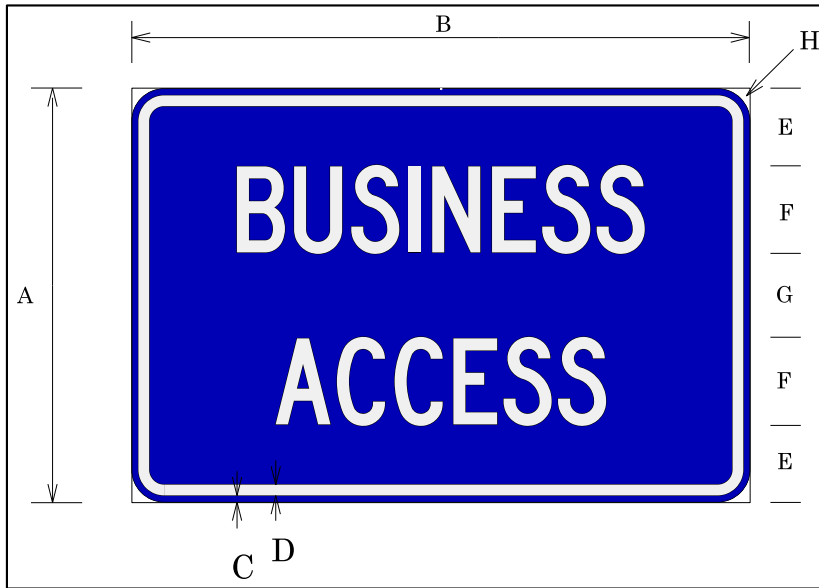

Table 147: Sign CG20-11 (BUSINESS ACCESS) Dimensions (inches)

A	B	C	D	E	F	G	H
24	36	0.375	0.625	4.5	5C	5	1.5

Sign Background: Blue, standard retroreflective sheeting.

Sign Legend: White, standard retroreflective sheeting.

The BUSINESS ACCESS sign may be used to inform the motorist where the business access is located during the construction work.

See section Business Access Signs in Construction Projects in this chapter for criteria and placement details.

The state traffic engineer approved the CG20-11 (BUSINESS ACCESS) sign in July 2001. The sign was last updated in July 2014.

# CG20-13

Figure 151: Sign CG20-13 (INTERMITTENT ROAD WORD NEXT XX MILES) Detail

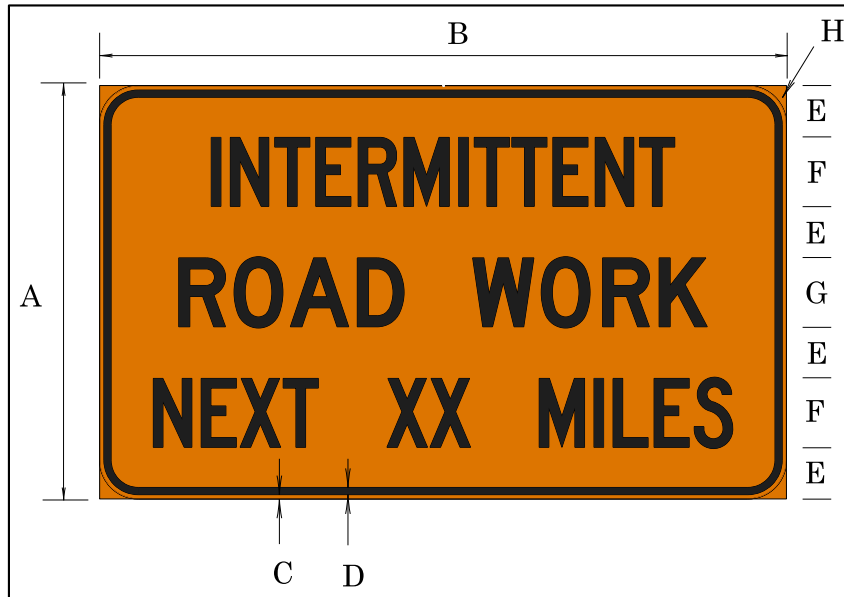

Table 148: Sign CG20-13 (INTERMITTENT ROAD WORD NEXT XX MILES) Dimensions (inches)

A	B	C	D	E	F	G	H
36	60	0.375	0.625	4.5	6C	6D	3

Sign Background: Fluorescent orange, standard retroreflective sheeting.

Sign Legend: Black, non-reflective sheeting.

The INTERMITTENT ROAD WORK NEXT XX MILES may be used to inform drivers of the nature of the work zone.

The distance shall be stated to the nearest whole mile.

The state traffic engineer approved the CG20-13 (INTERMITTENT ROAD WORK NEXT XX MILES) sign in July 2001. The sign was last updated in July 2014.

# CG20-20, CG20-20L, CG20-20R, CG20-20T, CG20-20LA, & CG20-20RA

Figure 152: Sign CG20-20, CG20-20L, CG20-20R, CG20-20T, CG20-20LA, & CG20-20RA (Pedestrian Event Route) Detail

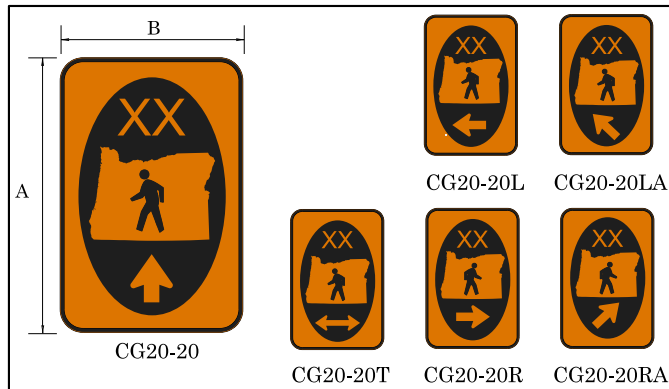

Table 149: Sign CG20-20, CG20-20L, CG20-20R, CG20-20T, CG20-20LA, & CG20-20RA (Pedestrian Event Route) Dimensions (inches)

A	B
17	11

Sign Background: Orange, non-reflective sheeting.

Oval Sign Background: Black, non-reflective sheeting.

Letters, Arrow, and State Sign Legend: Orange, non-reflective sheeting.

Pedestrian Symbol Sign Legend: Black, non-reflective sheeting.

The Pedestrian Event Route sign may be used for route marking of a permitted pedestrian event, as defined in OAR 734-056-0010 through 734-056-0050.

Each event will have its own unique letter/number designation, maximum three letters or numbers.

Signs shall be created by using word files available from the traffic standards unit. Please call 503-986-3568 to obtain them. Users can modify the unique letter/number designations, as appropriate. Print signs on 11x17 paper (or better) and laminate.

Signs may be installed a minimum of 2' below any traffic control device or on a separate path. Remove all signs as directed by the road authority after event concludes.

The state traffic engineer approved the CG20-20, CG20-20L, CG20-20R, CG20-20T, CG20-20LA, & CG20-20RA (Pedestrian Event Route) sign in December 2009. The sign was last updated in May 2010.

# CG20-21, CG20-21L, CG20-21R, CG20-21T, CG20-21LA, & CG20-21RA

Figure 153: Signs CG20-21, CG20-21L, CG20-21R, CG20-21T, CG20-21LA, & CG20-21RA (Bicycle Event Route) Detail

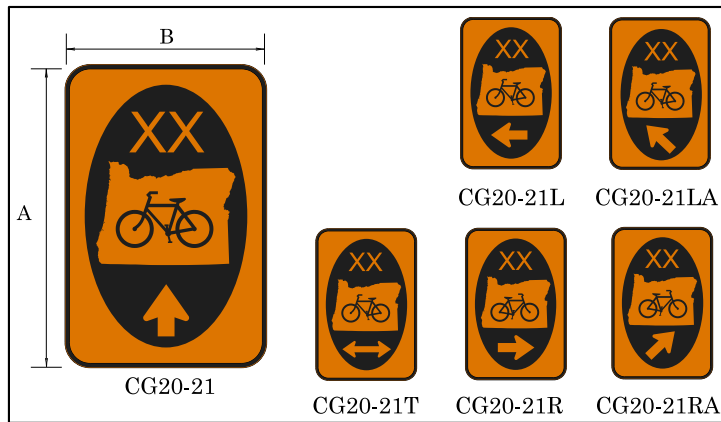

Table 150: Signs CG20-21, CG20-21L, CG20-21R, CG20-21T, CG20-21LA, & CG20-21RA (Bicycle Event Route) Dimensions (inches)

A	B
17	11

Sign Background: Orange, non-reflective sheeting.

Oval Sign Background: Black, non-reflective sheeting.

Letters, Arrow, and State Sign Legend: Orange, non-reflective sheeting.

Bike Symbol Sign Legend: Black, non-reflective sheeting.

The Bicycle Event Route sign may be used for route marking of a permitted bicycle event, as defined in OAR 734-056-0010 thru 734-056-0050.

Each event will have its own unique letter/number designation, maximum three letters or numbers, for example Cycle Oregon is CO and Cascade Cycling Classic is CCC.

Signs shall be created by using word files available from the traffic standards unit. Please call 503-986-3568 to obtain them. Users can modifying the unique letter/number designations as appropriate. Print signs on 11x17 paper (or better) and laminate.

Signs may be installed a minimum of 2' below any traffic control device or on a separate path. Remove all signs as directed by the road authority after event concludes.

The state traffic engineer approved the CG20-21, CG20-21L, CG20-21R, CG20-21T, CG20-21LA, & CG20-21RA (Bicycle Event Route) sign in December 2009. The sign was last updated in May 2010.



## CR1-1

Figure 154: Sign CR1-1 (STOP) Detail

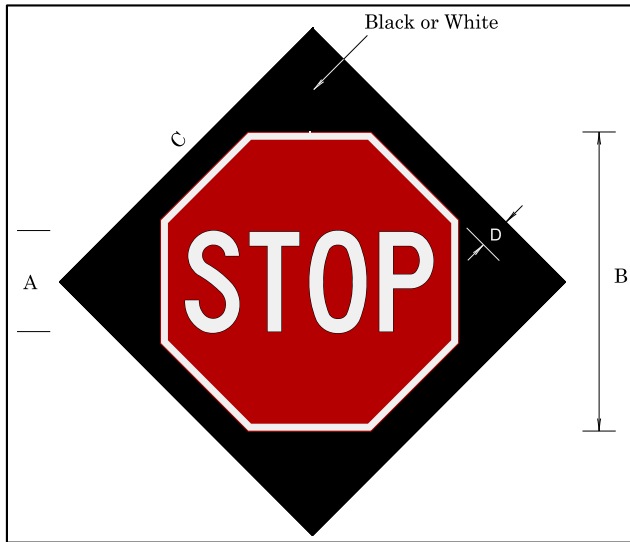

Table 151: Sign CR1-1 (STOP) Dimensions (inches)

A	B	C	D
10C	30 minimum	36 minimum	3

Stop Symbol Sign Background: Red, standard retroreflective sheeting.

Sign Background: Black, non-reflective sheeting or white, standard retroreflective sheeting.

Sign Legend: White, standard retroreflective sheeting.

The STOP roll-up sign may be used for short term emergency or hazard situations only.

Background sheeting may be either non-reflective black or retroreflective silver-white. Black background sheeting is preferred to accent the border of the STOP symbol. Use an approved sheeting material from the ODOT Qualified Products List, Section 00225.27.

The STOP roll-up sign shall not be used:

- For a time exceeding 72 consecutive hours.
- On construction projects.

Orange Sign Flag Boards may accompany the STOP roll-up sign in order to draw special attention to it.

The state traffic engineer approved the CR1-1 (STOP) sign in September 2005.

## CR4-20

Figure 155: Sign CR4-20 (WAIT FOR PILOT CAR) Detail

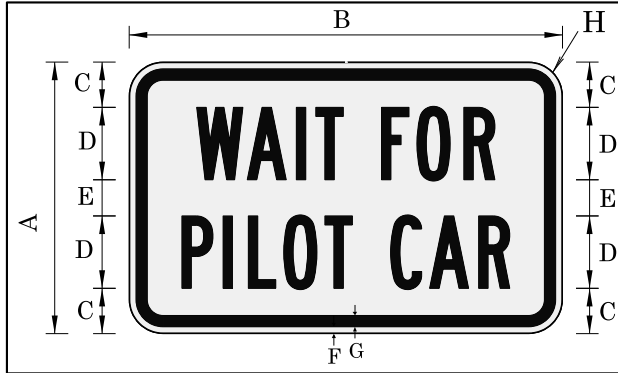

Table 152: Sign CR4-20 (WAIT FOR PILOT CAR) Dimensions (inches)

A	B	C	D	E	F	G	H
15	24	2.5	4B	2	0.375	0.625	1.5

Sign Background: White, standard retroreflective sheeting.

Sign Legend: Black, non-reflective sheeting.

Instead of flaggers, the WAIT FOR PILOT CAR sign may be posted on side roads or accesses intersecting state highways when using pilot cars to control traffic on the mainline through the work zone, provided:

- Access or side road traffic is stopped for no more than 20 minutes (per Section 00220 of the Oregon Standard Specifications for Construction, and Chapter 3 of the Oregon Temporary Traffic Control Handbook).
- Access or side road is a dead-end facility or has no immediate alternate access, has an ADT of 100 vehicles per day or less, and does not access public service facilities (e.g. parks, rest stops, waysides, ranger stations, landfills, utility hubs, treatment plants, etc.)

For private residential driveways, see sign CR4-20a.

Intersections or accesses using the WAIT FOR PILOT CAR sign should be checked regularly to ensure safe and effective traffic operations.

For a facility with an ADT greater than 100, but not exceeding 400 – the sign may be used only if closely monitored and frequently checked for traffic compliance, operation and safety. If operational issues are observed at these or any other location using the WAIT FOR PILOT CAR sign, the sign should be replaced by flagging or other traffic control measures as quickly as practical.

The state traffic engineer approved the CR4-20 (WAIT FOR PILOT CAR) sign in April 2011. The sign was last updated in January 2014.

## CR4-20a

Figure 156: Sign CR4-20a (WAIT FOR PILOT CAR) Detail

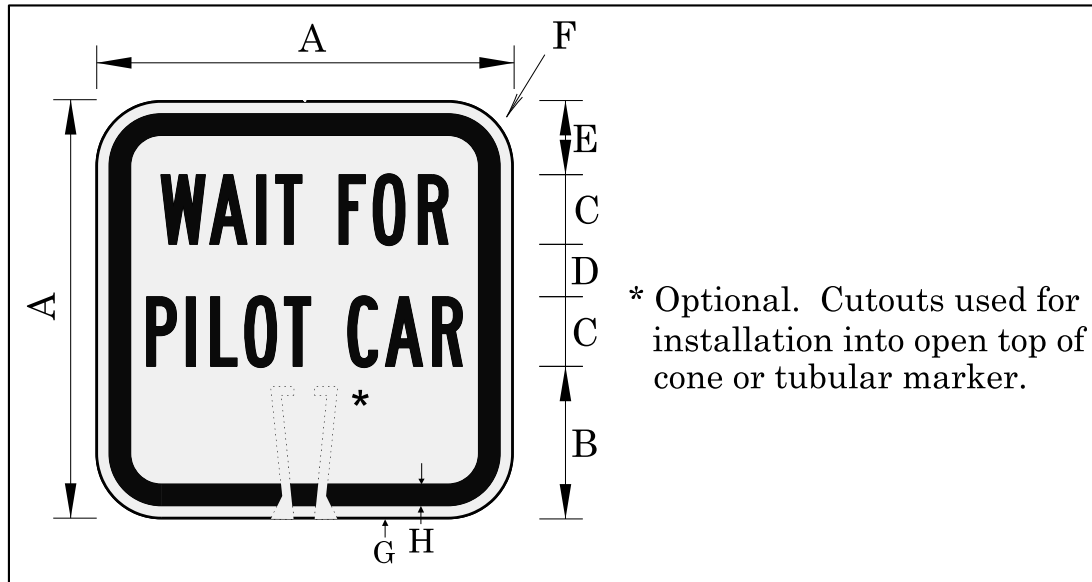

Table 153: Sign CR4-20a (WAIT FOR PILOT CAR) Dimensions (inches)

A	B	C	D	E	F	G	H
12	4.5	2B	1.5	2	1.5	0.375	0.625

Sign Background: White, standard retroreflective sheeting.

Sign Legend: Black, non-reflective sheeting.

The 1' x 1' WAIT FOR PILOT CAR sign may be used during ODOT maintenance operations where flaggers and pilot cars are controlling traffic (e.g. chip seals, paving, etc.).

Place the signs in private residential driveways only. Sign must face private residences only and not be visible to public traffic. Do not install the sign in driveways that have apartments or condominiums or in business accesses.

Signs may be fabricated using fiberboard or other lightweight substrate material. The sign may be installed into the top of a conical or tubular marker by cutting the bottom of the sign, as shown, to provide a snug fit into the top of the device.

Public notification (e.g. door hangers, fliers) may accompany the installation of the signs.

The state traffic engineer approved the CR4-20a (WAIT FOR PILOT CAR) sign in March 2013. The sign was last updated in January 2018.

## CR4-22a & CR4-22b

Figure 157: Sign CR4-22a & CR4-22b (KEEP LEFT (RIGHT)) Detail

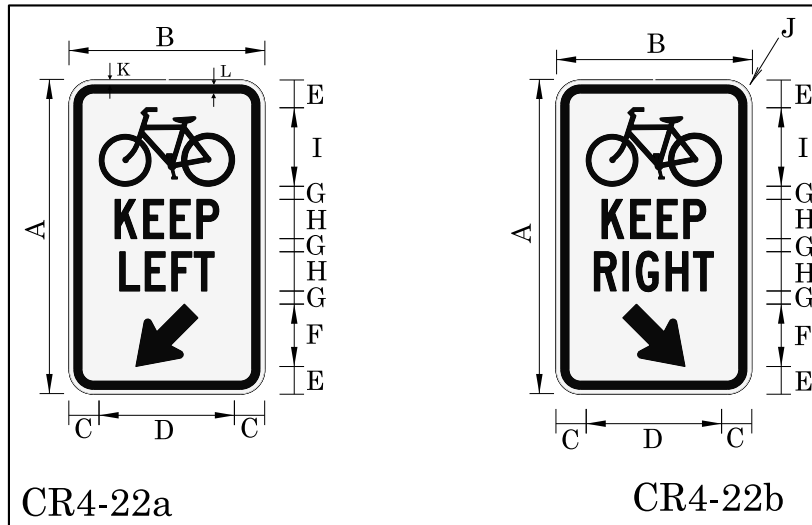

Table 154: Sign CR4-22a & CR4-22b (KEEP LEFT (RIGHT)) Dimensions (inches)

A	B	C	D	E	F	G	H	I	J	K	L
24	15	2.3	10.4	2.1	4.8	1	3C	6	1.5	0.375	0.625

\*4"X6" Arrows at 45 degrees

Sign Background: White, standard retroreflective sheeting.

Sign Legend: Black, non-reflective sheeting.

Use the Bicycles KEEP LEFT (RIGHT) sign (CR4-22a, CR4-22b) at the beginning of a section of temporary bicycle pathway within a construction work zone. The sign directs bicycle traffic into the temporary bicycle pathway and out of the active work area. The sign may be repeated at regular intervals throughout a longer work zone as a reminder to bicycle traffic.

See the ODOT Traffic Control Plans Design Manual for additional details.

The state traffic engineer approved the CR4-22a & CR4-22b (KEEP LEFT (RIGHT)) sign in March 2016. The sign was last updated in June 2017.

# CR4-23

Figure 158: Sign CR4-23 (WAIT FOR FLAGGER) Detail

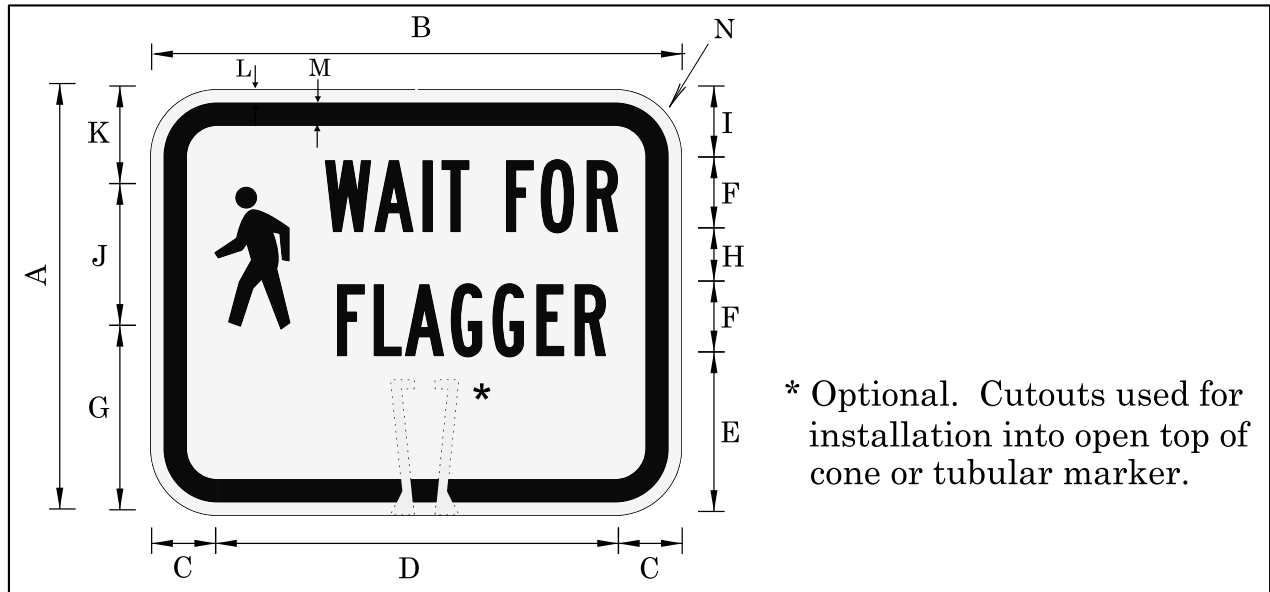

Table 155: Sign CR4-23 (WAIT FOR FLAGGER) Dimensions (inches)

A	B	C	D	E	F	G	H	I	J	K	L	M	N
12	15	1.8	11.4	4.5	2B	5.2	1.5	2	4	2.8	0.375	0.625	1.5

Sign Background: White, standard retroreflective sheeting.

Sign Legend: Black, non-reflective sheeting.

Use the 1' x 1'-3" Pedestrian WAIT FOR FLAGGER sign:

- In conjunction with flagging operations where pedestrians must cross live traffic lanes to access a temporary pedestrian access route (TPAR).
- Where "Pedestrian Flaggers" are used to guide/escort pedestrians across a TPAR bisecting an active work space.

The sign shall be placed at each flagger station facing incoming pedestrian traffic.

Signs shall be fabricated using retroreflective sheeting on aluminum, plywood, or lightweight substrate material (e.g. fiberboard, foam board). The sign may be installed into the top of a conical or tubular marker by cutting the bottom of the sign, as shown, to provide a snug fit into the top of the device.

The state traffic engineer approved the CR4-23 (WAIT FOR FLAGGER) sign in May 2017.

# CR4-24

Figure 159: Sign CR4-24 (WAIT FOR ASSISTANCE) Detail

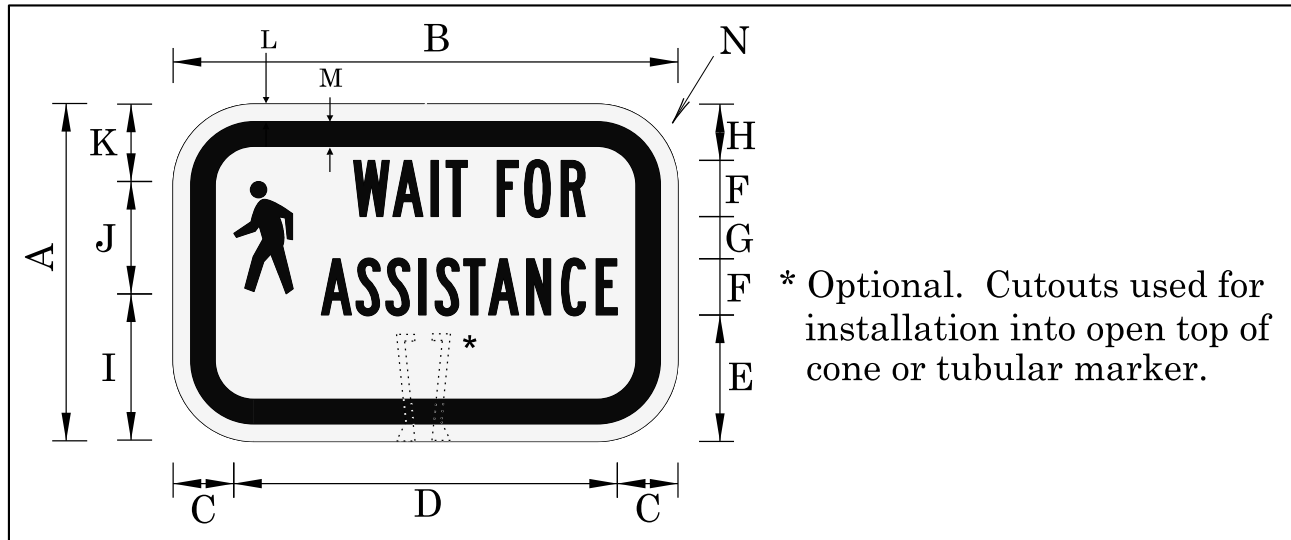

Table 156: Sign CR4-24 (WAIT FOR ASSISTANCE) Dimensions (inches)

A	B	C	D	E	F	G	H	I	J	K	L	M	N
12	18	2.15	13.7	4.5	2B	1.5	2	5.2	4	2.8	0.375	0.625	1.5

Sign Background: White, standard retroreflective sheeting.

Sign Legend: Black, non-reflective sheeting.

Use the 1' x 1'-6" Pedestrian WAIT FOR ASSISTANCE sign where pedestrians must access a TPAR within an active work space and where construction staff are used to guide/escort pedestrians through the TPAR.

Signs shall be placed at the starting point at each end of the TPAR facing incoming pedestrian traffic.

Signs shall be fabricated using retroreflective sheeting on aluminum, plywood, or lightweight substrate material (e.g. fiberboard, foam board). The sign may be installed into the top of a conical or tubular marker by cutting the bottom of the sign, as shown, to provide a snug fit into the top of the device.

The state traffic engineer approved the CR4-24 (WAIT FOR ASSISTANCE) sign in June 2017.

# CW11-1

Figure 160: Sign CW11-1 (Bicycles ON ROADWAY) Detail

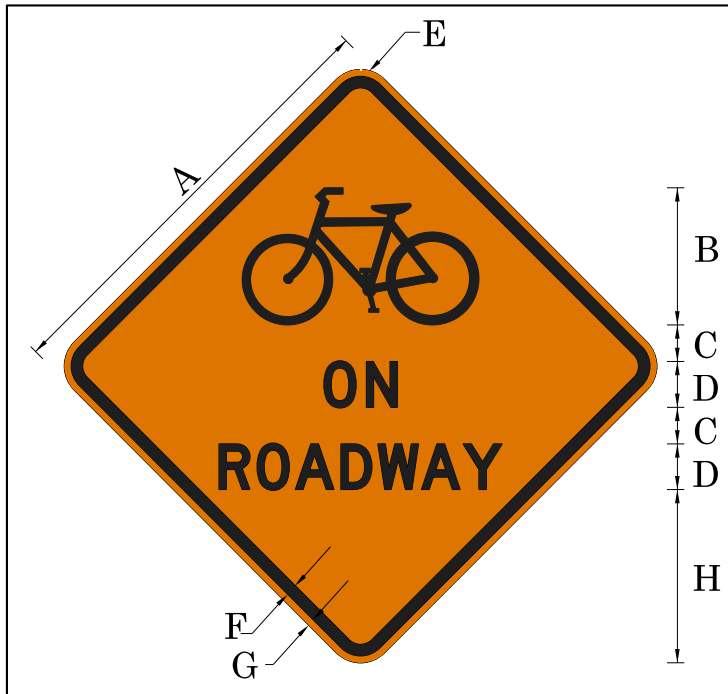

Table 157: Sign CW11-1 (Bicycles ON ROADWAY) Dimensions (inches)

Sign Size	A	B	C	D	E	F	G	H
Minimum	36	12	2.5	8C	2.25	0.875	0.625	15
Standard	48	16.5	3	6C	3	1.25	0.75	19

Sign Background: Fluorescent orange, standard retroreflective sheeting.

Sign Legend: Black, non-reflective sheeting.

The Bicycles ON ROADWAY symbol sign:

- May be used to warn motorists of the presence of bicycles in the traffic lane.
- Should be used when construction work, maintenance operations or other roadway activity prevents bicycles from using the shoulder or bike lane.

The state traffic engineer approved the CW11-1 (Bicycles ON ROADWAY) sign in December 2009. The sign was last updated in July 2014.



# CW11-1a

Figure 161: Sign CW11-1a (Bicycles CROSSING ROADWAY) Detail

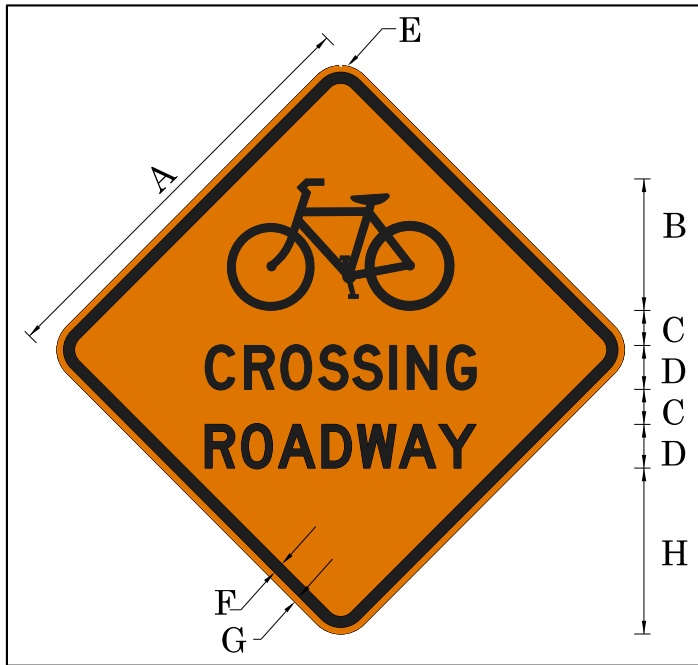

Table 158: Sign CW11-1a (Bicycles CROSSING ROADWAY) Dimensions (inches)

Sign Size	A	B	C	D	E	F	G	H
Minimum	36	10	3	4D	2.25	0.875	0.625	16
Standard	48	15	4	5D	3	1.25	0.75	19

Sign Background: Fluorescent orange, standard retroreflective sheeting.

Sign Legend: Black, non-reflective sheeting.

The Bicycles CROSSING ROADWAY sign may be used at, and in advance of, crossing locations within the limits of a permitted bicycle event, as defined in OAR 734-056-0010 through 734-056-0050.

The state traffic engineer approved the CW11-1a (Bicycles CROSSING ROADWAY) sign in December 2009. The sign was last updated in July 2014.

# CW11-2

Figure 162: Sign CW11-2 (Pedestrians ON ROADWAY) Detail

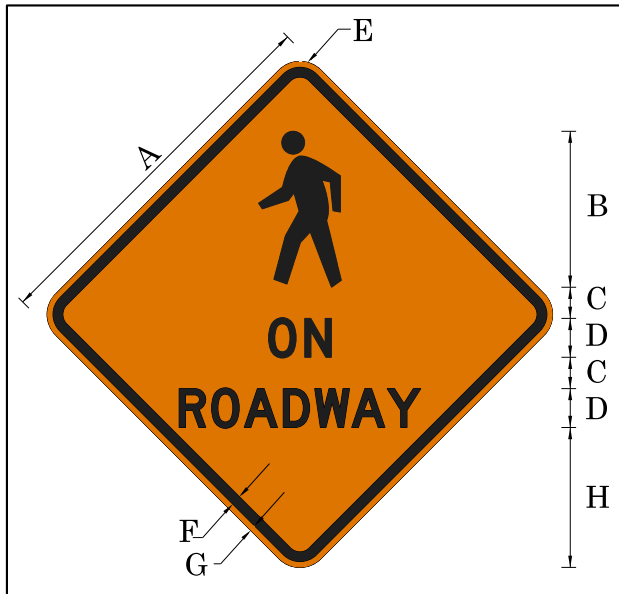

Table 159: Sign CW11-2 (Pedestrians ON ROADWAY) Dimensions (inches)

Sign Type	A	B	C	D	E	F	G	H
Minimum	36	15	3	4D	2.25	0.875	0.625	14
Standard	48	20	4	5D	3	1.25	0.75	18

Sign Background: Fluorescent orange, standard retroreflective sheeting.

Sign Legend: Black, non-reflective sheeting.

The Pedestrians ON ROADWAY may be used to inform motorists that pedestrians may be present in the roadway within the limits of a permitted pedestrian event, as defined in OAR 734-056-0010 through 734-056-0050.

The state traffic engineer approved the CW11-2 (Pedestrians ON ROADWAY) sign in December 2009. The sign was last updated in July 2014.

# CW11-2a

Figure 163: Sign CW11-2a (Pedestrians CROSSING ROADWAY) Detail

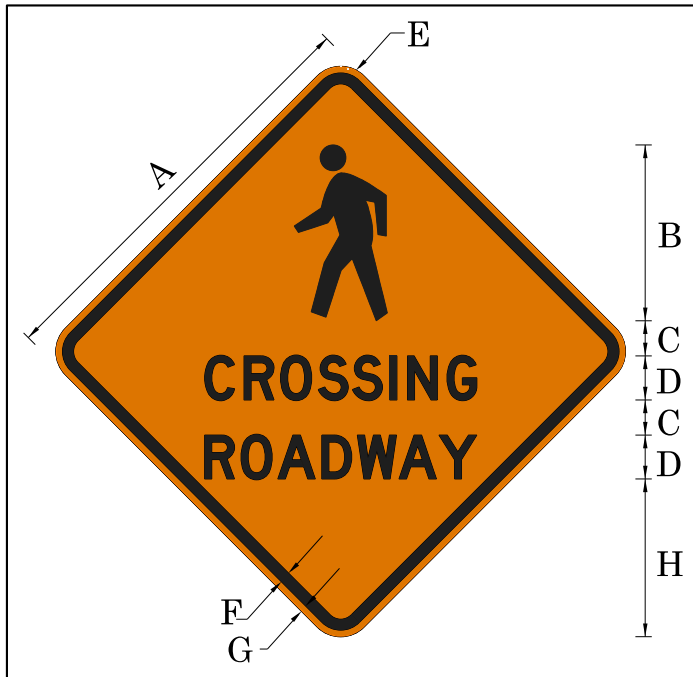

Table 160: Sign CW11-2a (Pedestrians CROSSING ROADWAY) Dimensions (inches)

Sign Type	A	B	C	D	E	F	G	H
Minimum	36	15	3	4D	2.25	0.875	0.625	14
Standard	48	20	4	5D	3	1.25	0.75	18

Sign Background: Fluorescent orange, standard retroreflective sheeting.

Sign Legend: Black, non-reflective sheeting.

The Pedestrians CROSSING ROADWAY sign may be used at, and in advance of, crossing locations within the limits of a permitted pedestrian event, as defined in OAR 734-056-0010 through 734-056-0050.

The state traffic engineer approved the CW22-2a (Pedestrians CROSSING ROADWAY) sign in December 2009. The sign was last updated in July 2014.

# CW11-3

Figure 164: Sign CW11-3 (SIDEWALK OPEN) Detail

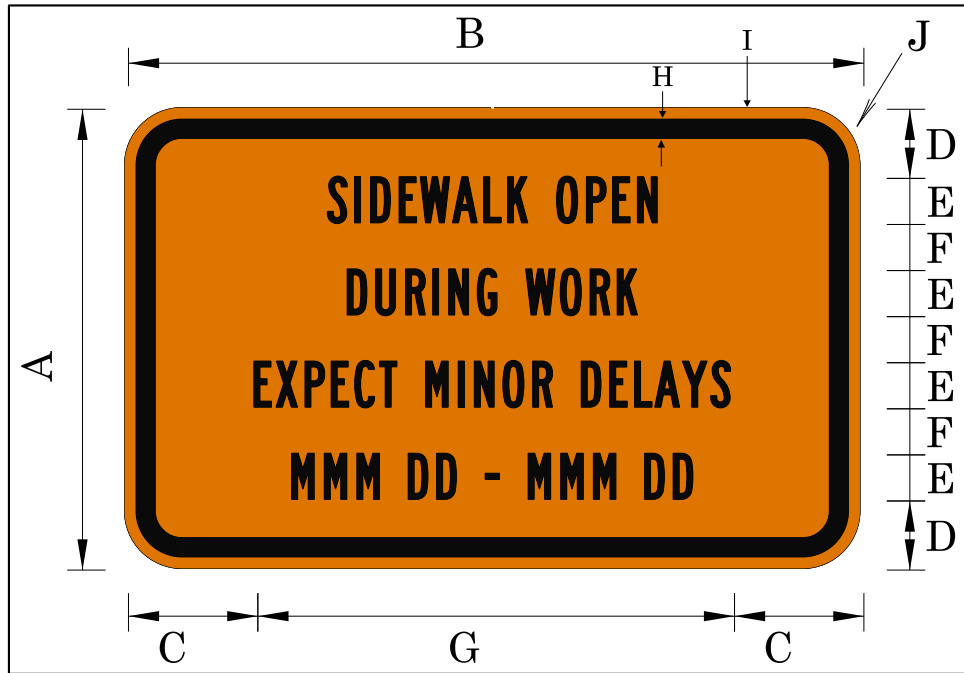

Table 161: Sign CW11-3 (SIDEWALK OPEN) Dimensions (inches)

A	B	C	D	E	F	G	H	I	J
15	24	4.2	2.25	1.5B	1.5	15.6	0.625	0.375	1.5

Sign Background: Fluorescent orange, standard retroreflective sheeting.

Sign Legend: Black, non-reflective sheeting.

The SIDEWALK OPEN sign shall be posted as advance notification to pedestrians when intermittent work may temporarily block the pedestrian pathway for short durations not exceeding five minutes in duration each.

Dates shown on the sign, should be a combination of alpha and numeric characters (e.g. APR 22). If the work spans two different years, convert lettering to a MM/DD/YY format and the time span rewritten as: MM/DD/YY - MM/DD/YY. For example: 10/31/17 - 02/05/18.

The state traffic engineer approved the CW11-3 (SIDEWALK OPEN) sign in March 2017. The sign was last updated in June 2017.

# CW11-4

Figure 165: Sign CW11-4 (SIDEWALK CLOSED) Detail

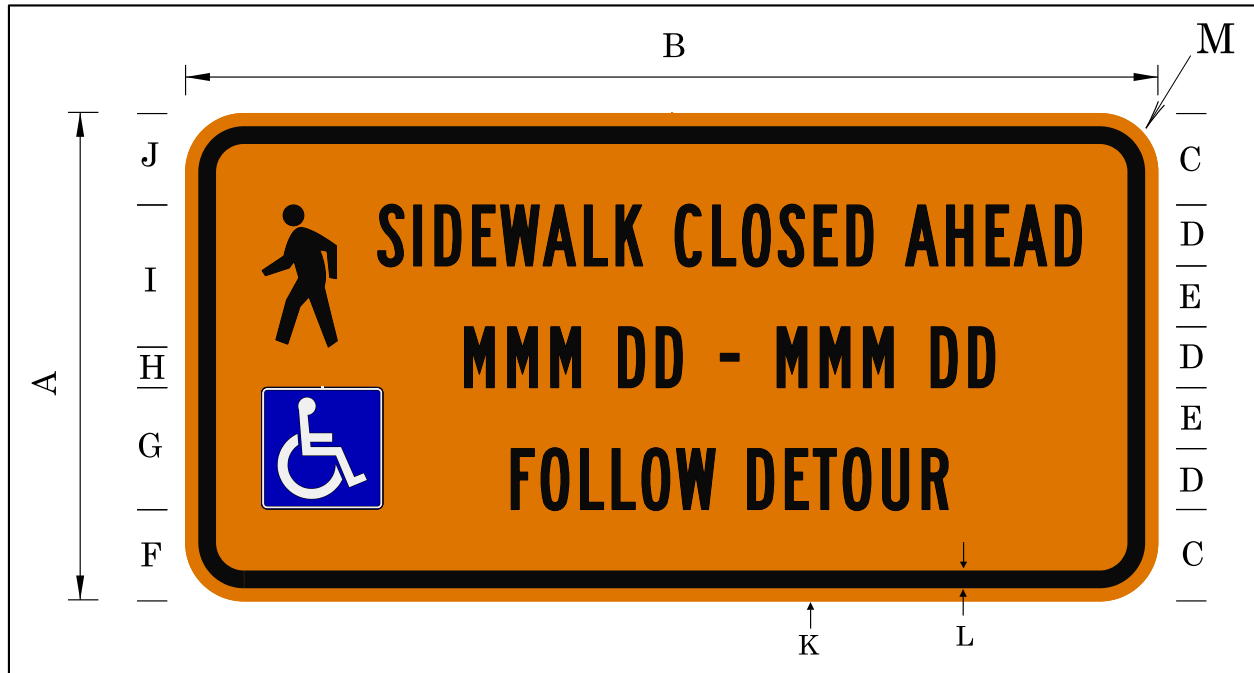

Table 162: Sign CW11-4 (SIDEWALK CLOSED) Dimensions (inches)

A	B	C	D	E	F	G	H	I	J	K	L	M
12	24	2.25	1.5B	1.5	2.2	3	1	3.5	2.3	0.375	0.625	1.5

Sign Background: Fluorescent orange, standard retroreflective sheeting.

Sign Legend:

- Black, non-reflective sheeting.
- White standard retroreflective sheeting with blue EC film overlay (wheelchair symbol).

The SIDEWALK CLOSED, Full Time sign shall be posted as advance notification to pedestrians when a sidewalk or pedestrian pathway is to be closed, full time, for a given period of time indicated on the sign.

Dates shown on the sign, should be a combination of alpha and numeric characters (e.g. APR 22). If the closure spans two different years, convert lettering to a MM/DD/YY format and the time span rewritten as: MM/DD/YY - MM/DD/YY. For example: 10/31/17 - 02/05/18.

The state traffic engineer approved the CW11-4 (SIDEWALK CLOSED) sign in March 2017. The sign was last updated in June 2017.

# CW11-5

Figure 166: Sign CW11-5 (SIDEWALK CLOSED) Detail

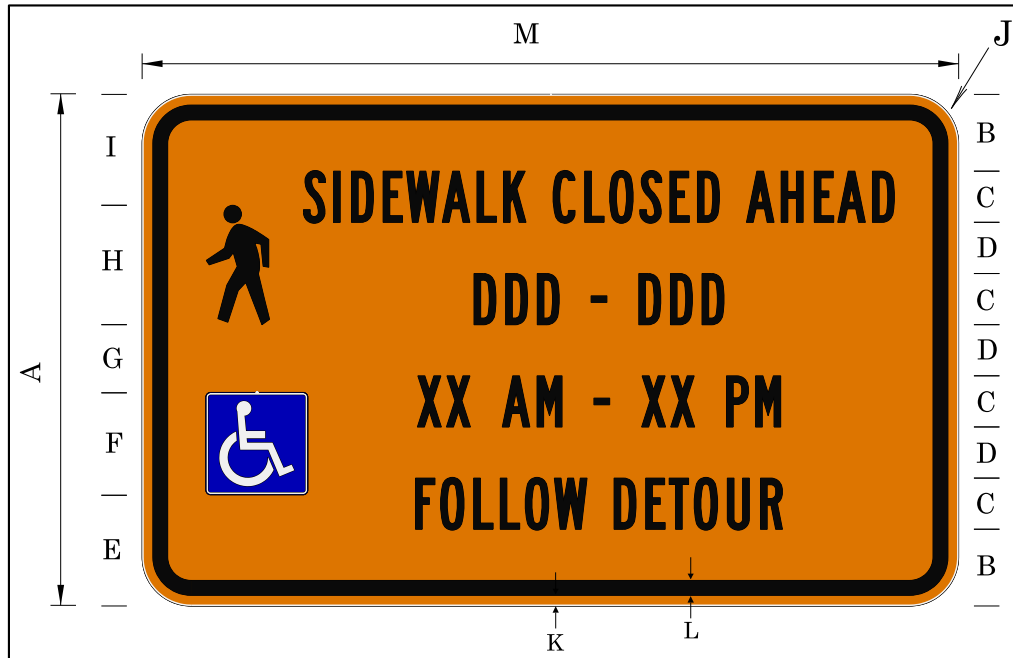

Table 163: Sign CW11-5 (SIDEWALK CLOSED) Dimensions (inches)

A	B	C	D	E	F	G	H	I	J	K	L	M
15	2.25	1.5B	1.5	3.2	3	2	3.5	3.3	1.5	0.375	0.625	24

Sign Background: Fluorescent orange, standard retroreflective sheeting.

Sign Legend:

- Black, non-reflective sheeting.
- White standard retroreflective sheeting with blue EC film overlay (wheelchair symbol).

The SIDEWALK CLOSED, Daily sign shall be posted as advance notification to pedestrians when a sidewalk or pedestrian pathway is to be closed on a daily basis where the route is reopened to pedestrian traffic at the end of each work shift, or on weekends, or on other specific days of the week.

Abbreviate the days shown on the sign. Adjust the "AM" and "PM" designation to reflect day or nighttime work.

The state traffic engineer approved the CW11-5 (SIDEWALK CLOSED) sign in March 2017. The sign was last updated in June 2017.

# CW15-10

Figure 167: Sign CW15-10 (WRECK AHEAD) Detail

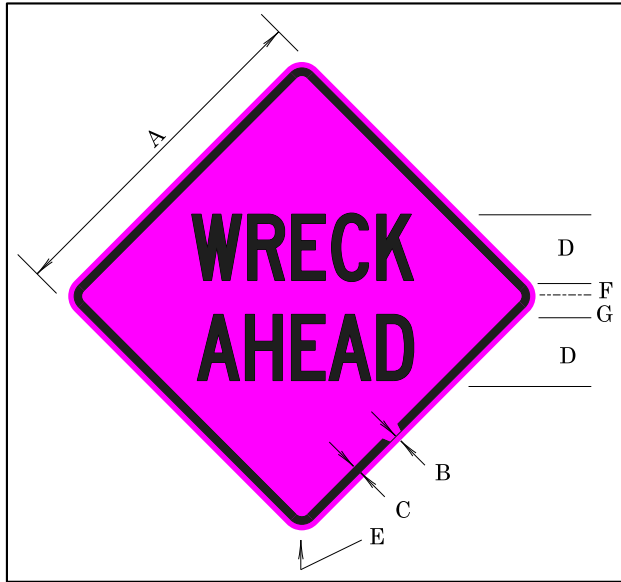

Table 164: Sign CW15-10 (WRECK AHEAD) Dimensions (inches)

Sign Type	A	B	C	D	E	F	G
Minimum	30	0.5	0.75	6C	1.875	1	2
Standard	36	0.625	0.875	7C	2.25	1.75	1.75
Special	48	0.75	1.25	8D	3	2.5	2.5
Special	60	0.75	1.25	11D*	3	3.5	4.5

\*Use 11C Spacing

Sign Background: Fluorescent pink, standard retroreflective sheeting.

Sign Legend: Black, non-reflective sheeting.

Road authorities, emergency vehicles and certified tow vehicle operations may temporarily use the WRECK AHEAD sign to meet the signing requirements of ORS 822.220. The signs shall be removed when the hazard no longer exists.

Existing WRECK AHEAD signs with orange retroreflective background may be used until damaged or worn out.

The OTC approved the CW15-10 (WRECK AHEAD) sign in January 1992. The sign was last updated in July 2014.

# CW15-15

Figure 168: Sign CW15-15 (EVENT AHEAD) Detail

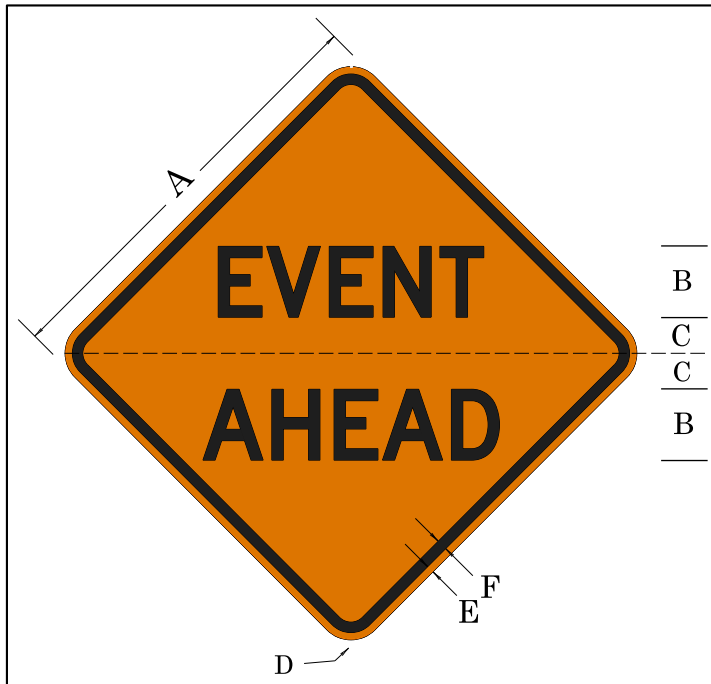

Table 165: Sign CW15-15 (EVENT AHEAD) Dimensions (inches)

A	B	C	D	E	F
36	6D	3	2.25	0.625	0.875

Sign Background: Fluorescent orange, standard retroreflective sheeting.

Sign Legend: Black, non-reflective sheeting.

The EVENT AHEAD sign:

- Shall be used to warn of pedestrian activity, per OAR 734-058-0010 through 734-058-0080.
- May be used to warn of a special event, per OAR 734-056-0010 through 734-056-0050.

The state traffic engineer approved the CW15-15 (EVENT AHEAD) sign in January 2009. The sign was last updated in July 2014.



# CW15-15a

Figure 169: Sign CW15-15a (Bicycle EVENT AHEAD) Detail

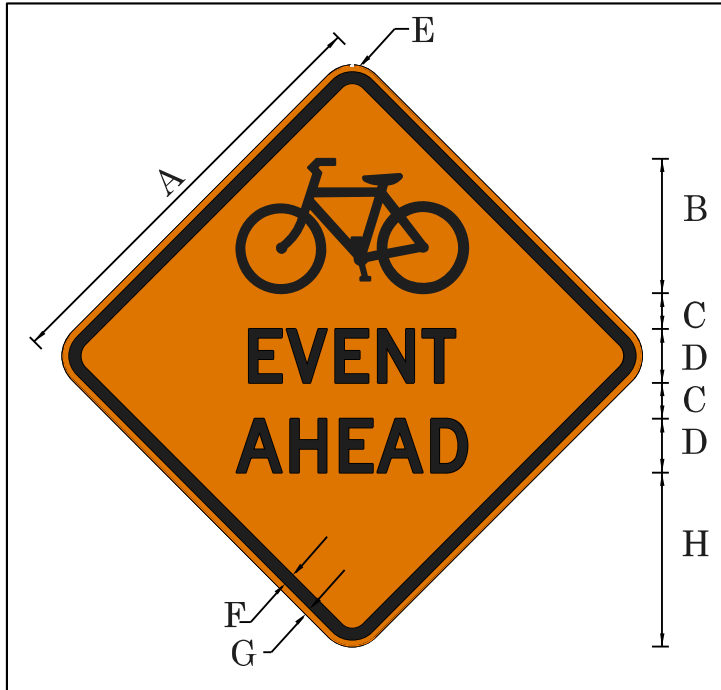

Table 166: Sign CW15-15a (Bicycle EVENT AHEAD) Dimensions (inches)

Sign Type	A	B	C	D	E	F	G	H
Minimum	36	10	3	4D	2.25	0.875	0.625	15
Standard	48	15	4	6D	3	1.25	0.75	19

Sign Background: Fluorescent orange, standard retroreflective sheeting.

Sign Legend: Black, non-reflective sheeting.

The Bicycle EVENT AHEAD sign may be used in advance of entry points of a permitted bicycle event as defined in OAR 734-056-0010 through 734-056-0050.

The EVENT AHEAD (CW15-15) sign may be used instead of sign CW15-15a.

The state traffic engineer approved the CW15-15a (Bicycle EVENT AHEAD) sign in December 2009. The sign was last updated in July 2014.

## CW15-15b

Figure 170: Sign CW15-15b (Pedestrian EVENT AHEAD) Detail



Table 167: Sign CW15-15b (Pedestrian EVENT AHEAD) Dimensions (inches)

Sign Type	A	B	C	D	E	F	G	H
Minimum	36	15	3	4D	2.25	0.875	0.625	13
Standard	48	20	4	6D	3	1.25	0.75	17

Sign Background: Fluorescent orange, standard retroreflective sheeting.

Sign Legend: Black, non-reflective sheeting.

The Pedestrian EVENT AHEAD sign may be used in advance of entry points of a permitted pedestrian event, as defined in OAR 734-056-0010 through 734-056-0050.

The EVENT AHEAD (CW15-15) sign may be used instead of sign CW15-15b.

The state traffic engineer approved the CW15-15b (Pedestrian EVENT AHEAD) sign in December 2009. The sign was last updated in July 2014.

# CW17-1

Figure 171: Sign CW17-1 (BICYCLE RACE IN PROGRESS) Detail

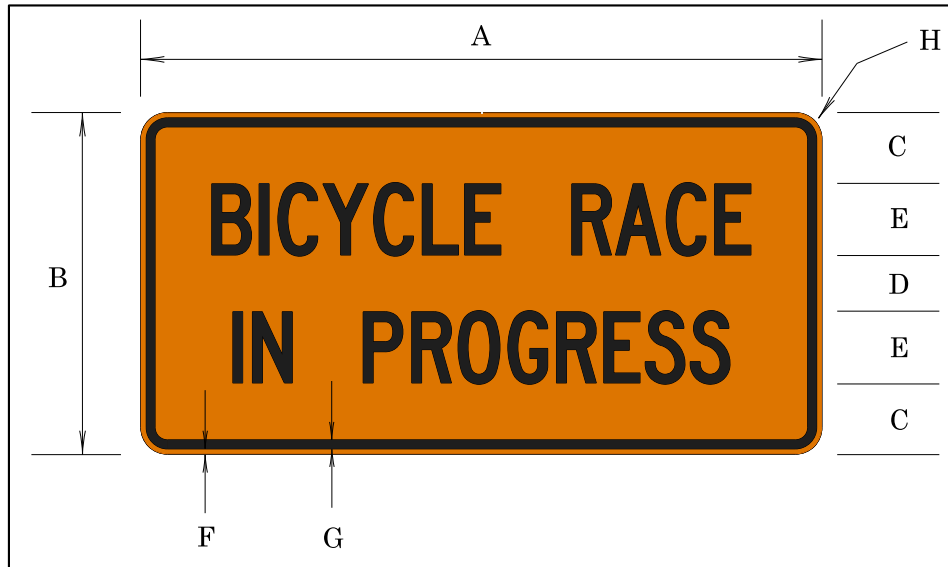

Table 168: Sign CW17-1 (BICYCLE RACE IN PROGRESS) Dimensions (inches)

Sign Type	A	B	C	D	E	F	G	H
Minimum	24	12	2.25	1.5	3B	0.25	0.25	0.5
Standard	48	24	5	4	5C	0.375	0.625	1.5

Sign Background: Fluorescent orange, standard retroreflective sheeting.

Sign Legend: Black, non-reflective sheeting.

The BICYCLE RACE IN PROGRESS sign shall be displayed on the bicycle race escort vehicles, if required by the race permit. See special events permits OAR 734-056-0010 through 734-056-0050.

The standard size sign should be used on state highways.

A lightweight sign substrate may be used.

The OTC approved the CW17-1 (BICYCLE RACE IN PROGRESS) sign in January 1992. The sign was last updated in July 2014.

# CW17-2

Figure 172: Sign CW17-2 (BICYCLE RIDE IN PROGRESS) Detail

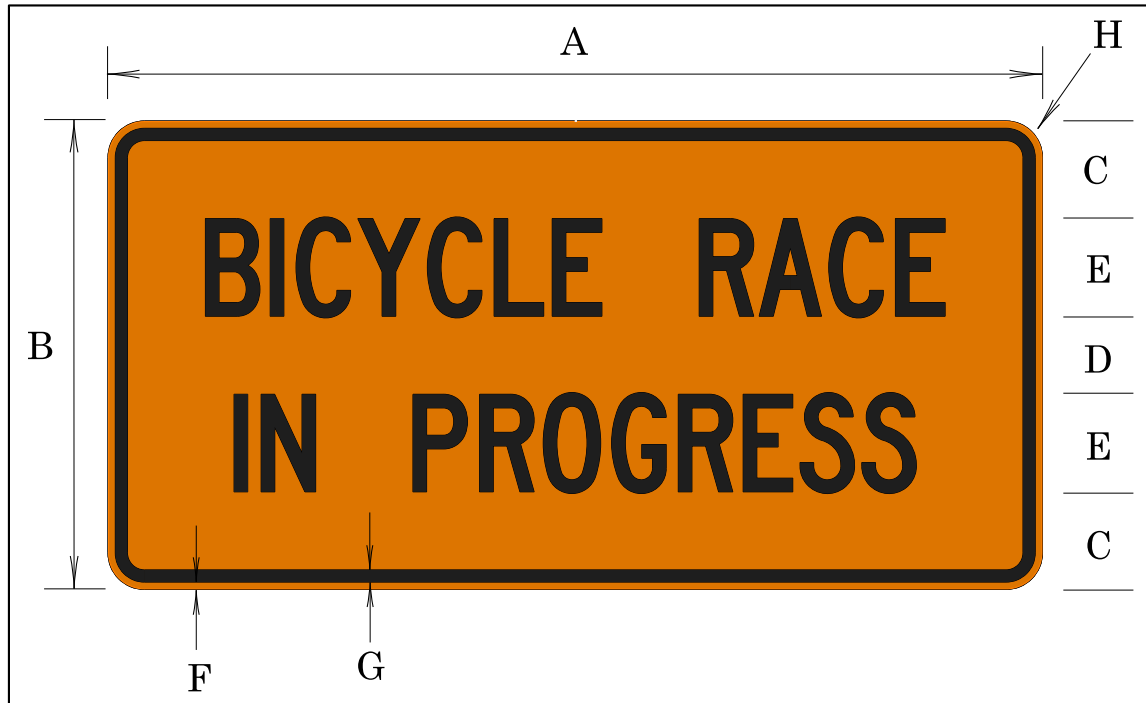

Table 169: Sign CW17-2 (BICYCLE RIDE IN PROGRESS) Dimensions (inches)

Sign Type	A	B	C	D	E	F	G	H
Minimum	24	12	2.25	1.5	3B	0.25	0.25	0.5
Standard	48	24	5	4	5C	0.375	0.625	1.5

Sign Background: Fluorescent orange, standard retroreflective sheeting.

Sign Legend: Black, non-reflective sheeting.

The "BICYCLE RIDE IN PROGRESS" sign shall be displayed on the bicycle ride escort vehicles, if required by the ride permit. See special event permits OAR 734-056-0010 through 734-056-0050. The standard size sign should be used on state highways.

A lightweight sign substrate may be used.

The OTC approved the CW17-2 (BICYCLE RIDE IN PROGRESS) sign in January 1992. The sign was last updated in July 2014.

## CW20-1a & CW8-7a

Figure 173: Signs CW20-1a & CW8-7a (ROAD WORK (LOOSE GRAVEL) XX MPH) Detail

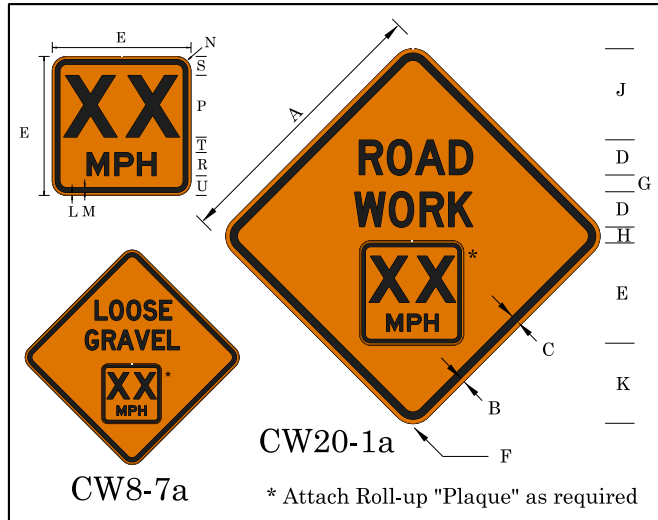

Table 170: Sign CW20-1a & CW8-7a (ROAD WORK (LOOSE GRAVEL) XX MPH) Dimensions (inches)

Sign Type	A	B	C	D	E	F	G	H	J	K
Minimum	36	0.625	0.875	5D	12	2.25	2.5	2.5	12.75	8.75
Standard	48	0.75	1.25	6D	18	3	3	4	15.875	11.875

Table 171: Speed Plaque Dimensions (inches)

Sign Type	L	M	N	P	R	S	T	U
Minimum	0.375	0.625	1.5	5E	2E	2.25	1	1.75
Standard	0.375	0.625	1.5	8E	3E	2.5	2	2.5

Sign Background: Fluorescent orange, standard retroreflective sheeting.

Sign Legend: Black, non-reflective sheeting.

The ROAD WORK (LOOSE GRAVEL) XX MPH roll-up sign may be used to advise motorists of the safe speed through a construction area. The sign shall be used only at the direction of the project manager/resident engineer of the contracting agency, and shall not be used to indicate any speed other than an advisory speed. Take care in determining the advisory speed, so as to obtain a safe and yet reasonable speed through the construction area.

The ROAD WORK (LOOSE GRAVEL) XX MPH roll-up sign shall be erected only in conjunction with, and immediately following, a ROAD WORK AHEAD sign (W20-1) and at intervals

through the construction area as needed. Make these signs with the intent and ability to accommodate removable XX MPH plaques, as appropriate.

The state traffic engineer approved the CW20-1a & CW8-7a (ROAD WORK (LOOSE GRAVEL) XX MPH) sign in May 2006. The sign was last updated in July 2014.

## CW20-5a

Figure 174: Sign CW20-5a (LEFT TWO LANES CLOSED AHEAD) Detail

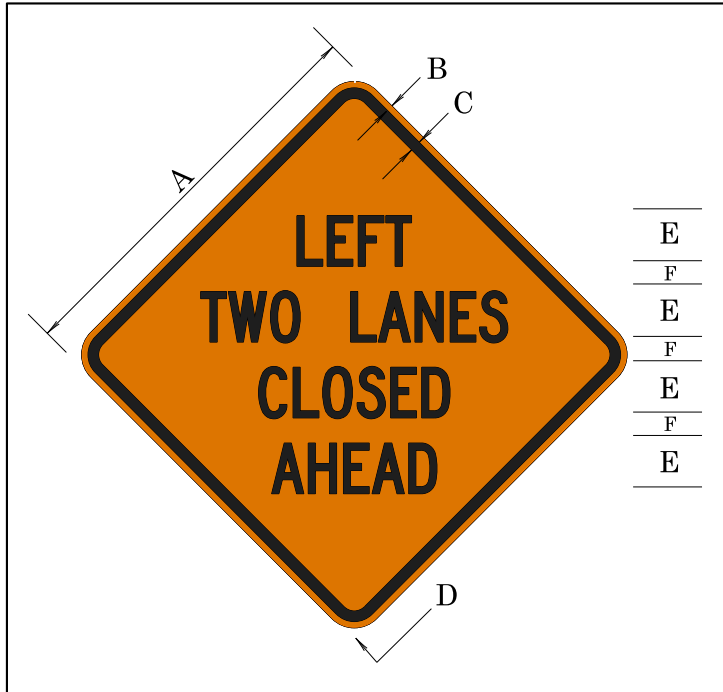

Table 172: Sign CW20-5a (LEFT TWO LANES CLOSED AHEAD) Dimensions (inches)

Sign Type	A	B	C	D	E	F
Minimum	36	0.625	0.875	2.25	5C	2
Standard	48	0.75	1.25	3	6C	3

Sign Background: Fluorescent orange, standard retroreflective sheeting.

Sign Legend: Black, non-reflective sheeting.

The LEFT TWO LANES CLOSED AHEAD sign shall be used in work zones in advance of locations where the left two adjacent lanes of a multi-lane roadway are closed.

The state traffic engineer approved the CW20-5a (LEFT TWO LANES CLOSED AHEAD) sign in September 2006. The sign was last updated in July 2014.

## CW20-5b

Figure 175: Sign CW20-5b (Flagger NEXT MILE) Detail

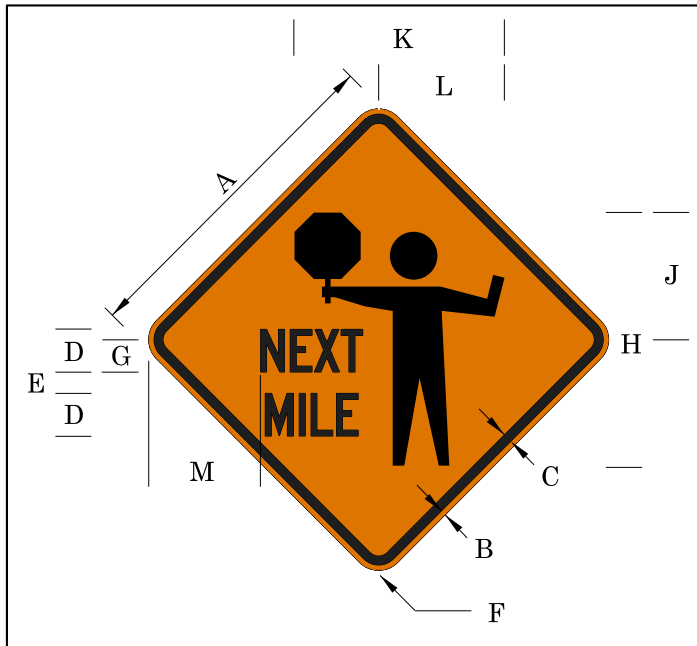

Table 173: Sign CW20-5b (Flagger NEXT MILE) Dimensions (inches)

Sign Type	A	B	C	D	E	F	G	H	J	K	L	M
Min.	36	0.625	0.875	5C	2.5	2.25	2.75	24	13	20	14.5	12.75
Std.	48	0.75	1.25	6C	3	3	4.25	36	17.5	30	17.25	15.5

Sign Background: Fluorescent orange, standard retroreflective sheeting.

Sign Legend: Black, non-reflective sheeting.

The Flagger NEXT MILE sign may be used to warn motorists of a flagger ahead for work zones moving along the road intermittently and with frequent short work durations. Only use this sign when the work can move through a one mile segment in three hours or less.

The Flagger NEXT MILE sign shall not be used for work zones that exceed one mile in length.

When the flagger is more than 1000 feet from the Flagger NEXT MILE sign, intermittent cones shall be placed on the shoulder. Cones should be placed at intervals indicated on diagram 325 of the Oregon Temporary Traffic Control Handbook.

The state traffic engineer approved the CW20-5b (Flagger NEXT MILE) sign in May 2006. The sign was last updated in July 2014.



# CW20-9

Figure 176: Sign CW20-9 (24-HOUR FLAGGING AHEAD) Detail



Table 174: Sign CW20-9 (24-HOUR FLAGGING AHEAD) Dimensions (inches)

A	B	C	D	E	F	G
48	6D	4	5	3	0.75	1.25

Sign Background: Fluorescent orange, standard retroreflective sheeting.

Sign Legend: Black, non-reflective sheeting.

The 24-HOUR FLAGGING AHEAD sign may be used for special emphasis when round-the-clock flagging operations are in place. This sign shall be removed when the condition no longer exists.

The state traffic engineer approved the CW20-9 (24-HOUR FLAGGING AHEAD) sign in May 2003. The sign was last updated in July 2014.

# CW21-7

Figure 177: Sign CW21-7 (ABRUPT EDGE) Detail

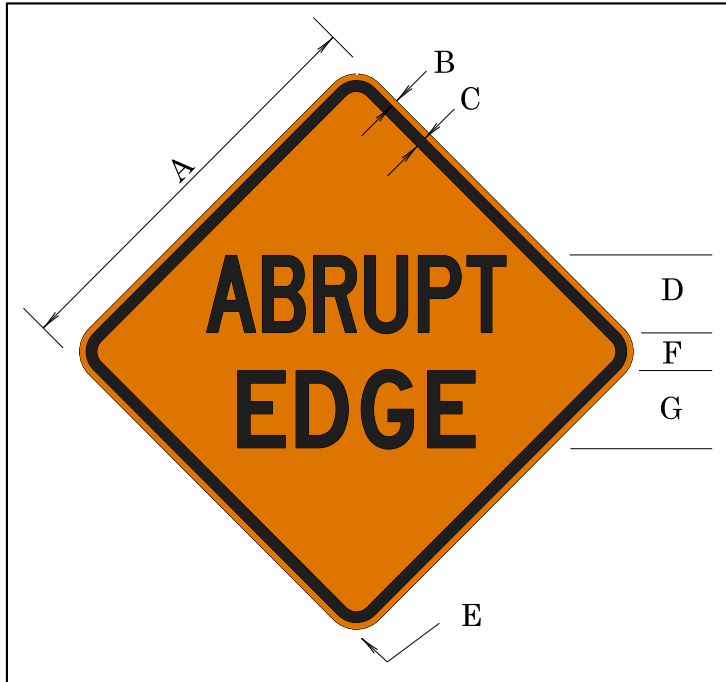

Table 175: Sign CW21-7 (ABRUPT EDGE) Dimensions (inches)

Sign Type	A	B	C	D	E	F	G
Minimum	36	0.625	0.875	7C	2.25	3.5	7D
Standard	48	0.75	1.25	9C	3	4.5	9D

Sign Background: Fluorescent orange, standard retroreflective sheeting.

Sign Legend: Black, non-reflective sheeting.

Use the ABRUPT EDGE sign in construction areas where the roadway is being repaved and paving operations are incomplete resulting in an abrupt pavement edge. Crews may also use the ABRUPT EDGE sign in construction areas where there is an area being excavated close to the travel lanes. When used in either circumstance, crews may supplement the sign with an appropriate rider (CW21-8a, CW21-8b or CW21-8c).

The OTC approved the CW21-7 (ABRUPT EDGE) sign in January 1990. The sign was last updated in July 2014.

## CW21-8A, CW21-8B, & CW21-8C

Figure 178: CW21-8A, CW21-8B & CW21-8C (Abrupt Edge Riders) Detail

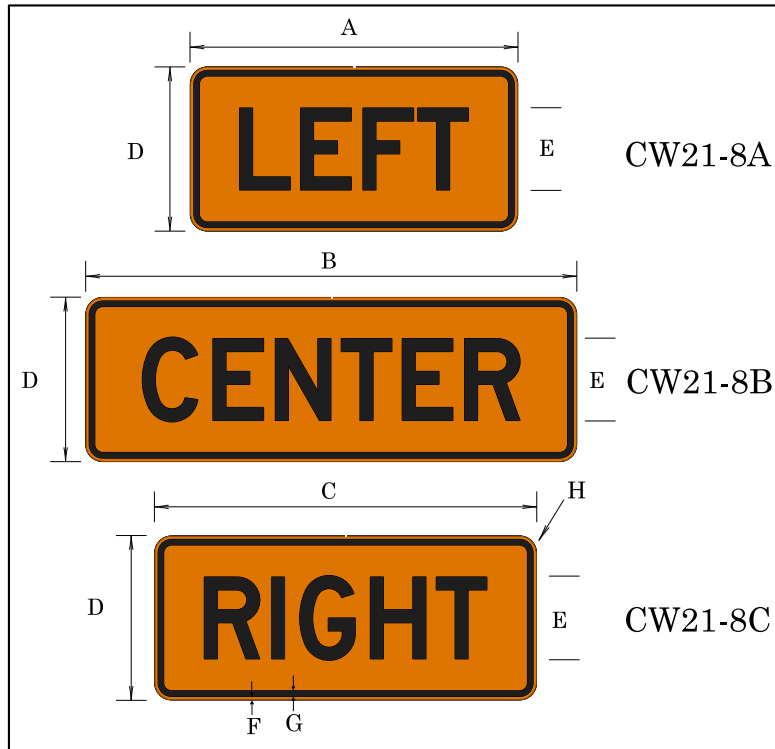

Table 176: CW21-8A, CW21-8B & CW21-8C (Abrupt Edge Riders) Dimensions (inches)

A	B	C	D	E	F	G	H
36	54	42	18	9D	0.375	0.625	1.5

Sign Background: Fluorescent orange, standard retroreflective sheeting.

Sign Legend: Black, non-reflective sheeting.

Abrupt Edge Riders: LEFT (CW21-8a), CENTER (CW21-8b), RIGHT (CW21-8c).

Use these riders to further identify the location of the abrupt pavement edge in relation to the lane of travel.

The OTC approved the CW21-8A, CW21-8B, CW21-9C (Abrupt Edge Riders) signs in January 1990. The sign was last updated in July 2014.

# CW21-9

Figure 179: Sign CW21-9 (ABRUPT EDGE) Detail

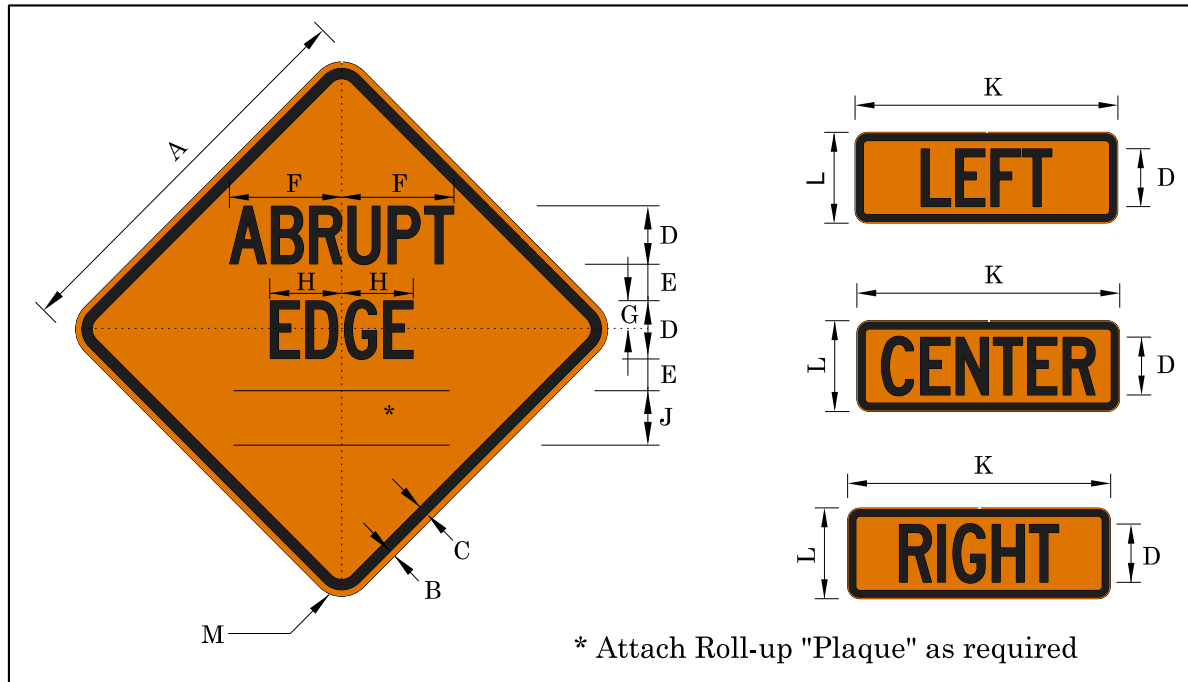

Table 177: Sign CW21-9 (ABRUPT EDGE) Dimensions (inches)

Sign Type	A	B	C	D	E	F	G	H	J	K	L	M
Minimum	36	0.625	0.875	5C	3.5	10.75	2.5	6.625	5	23	8	2.25
Standard	48	0.75	1.25	7C	4.5	15	3.5	9.25	7	32	11	3

Sign Background: Fluorescent orange, standard retroreflective sheeting.

Sign Legend: Black, non-reflective sheeting.

The ABRUPT EDGE roll-up sign may be used in lieu of sign CW21-7 and CW21-8 in construction areas where incomplete paving operations result in an abrupt edge. Make this sign with the intent and ability to accommodate removable LEFT, CENTER or RIGHT "Plaques."

The state traffic engineer approved the CW21-9 (ABRUPT EDGE) sign in October 2003. The sign was last updated in July 2014.

## CW21-10 & CW21-11

Figure 180: Sign CW21-10 & CW21-11 (BRIDGE WORK AHEAD) Detail

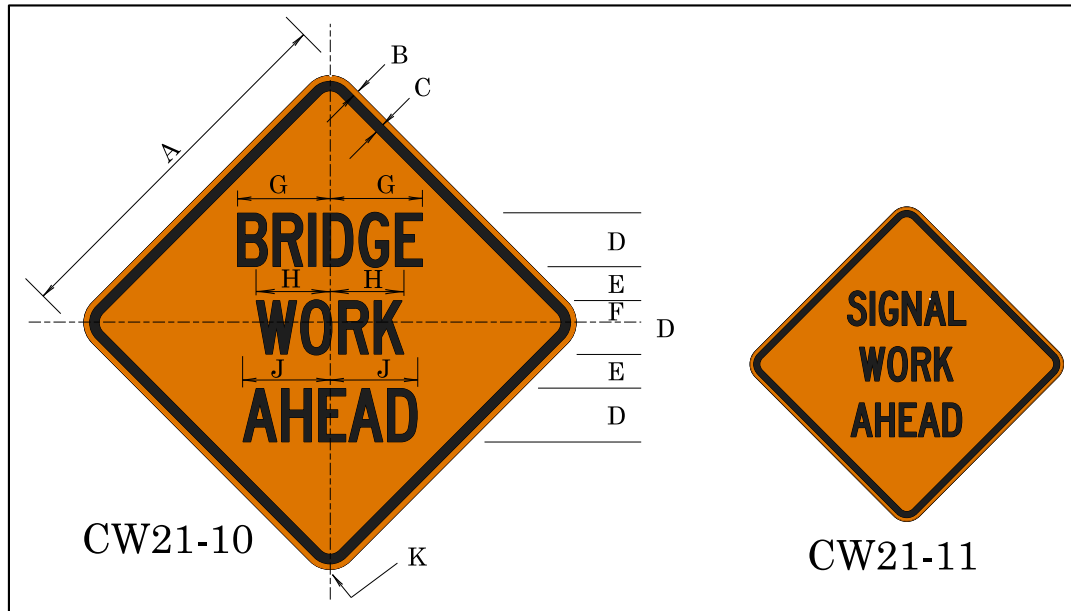

Table 178: Sign CW21-10 & CW21-11 (BRIDGE WORK AHEAD) Dimensions (inches)

Sign Type	A	B	C	D	E	F	G	H	J	K
Minimum	36	0.625	0.875	5C	3.25	2.125	9.563	7.5	8.75	2.25
Standard	48	0.75	1.25	7C	4.5	2.875	13.5	10.5	12.25	3

Sign Background: Fluorescent orange, standard retroreflective sheeting.

Sign Legend: Black, non-reflective sheeting.

The BRIDGE WORK AHEAD sign shall be used to warn motorists of bridge construction operations on, or adjacent to, the roadway when such construction is confined to the bridge itself.

When bridge construction is part of a continuous road construction zone, the use of this sign is optional. When used in conjunction with other signs, place it in advance of such signs.

The SIGNAL WORK AHEAD sign may be used in addition to all other required advance warning signs to inform motorists work is being performed on a traffic signal at an upcoming intersection, school crossing, etc.

The state traffic engineer approved the CW21-10 & CW21-11 (BRIDGE WORK AHEAD) sign in May 1995. The sign was last updated in July 2014.

# CW21-11

Figure 181: Sign CW21-11 (Horizontal Clearance) Detail

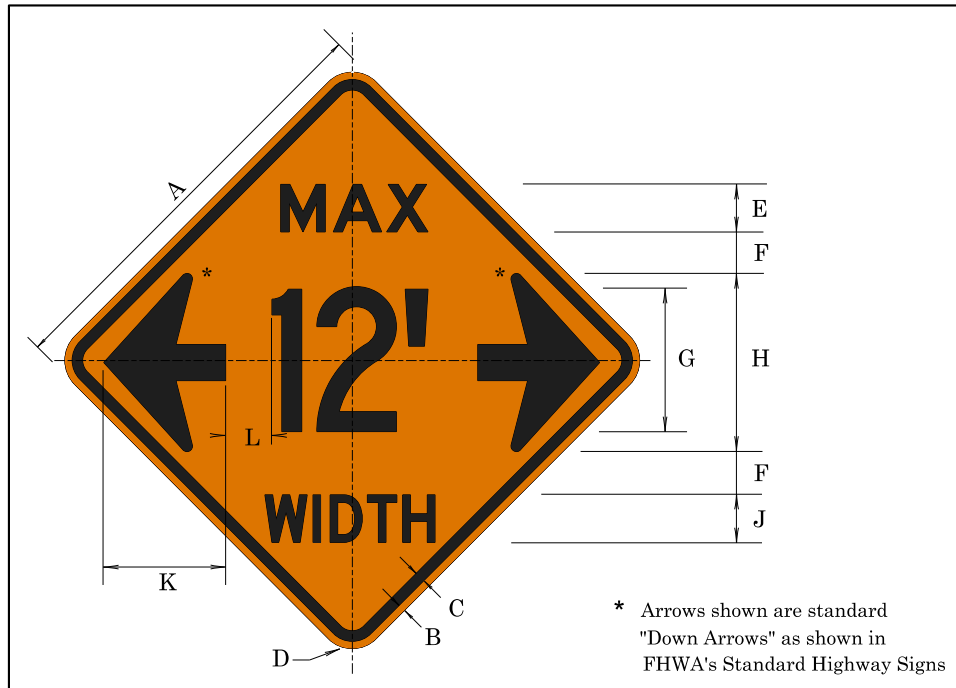

Table 179: Sign CW21-11 (Horizontal Clearance) Dimensions (inches)

Sign Type	A	B	C	D	E	F	G	H	J	K	L
Standard	36	0.625	0.875	2.25	4E	1.5	12C	15	4D	10.25	1.5
Special	48	0.75	1.25	3	6E	2	16C	20	6D	13.75	2

Sign Background: Fluorescent orange, standard retroreflective sheeting.

Sign Legend: Black, non-reflective sheeting.

The Horizontal Clearance sign may be used to warn motorists of road width reductions less than 19 feet between positive barriers on either side of the road (e.g. face of concrete barrier to face of concrete barrier, face of guardrail to face of guardrail). The actual width shall be shown to the nearest 1-foot, not exceeding the actual clearance.

The state traffic engineer approved the CW21-11 (Horizontal Clearance) sign in March 1994. The sign was last updated in July 2014.

## CW23-2

Figure 182: Sign CW23-2 (Flagger Ahead) Detail

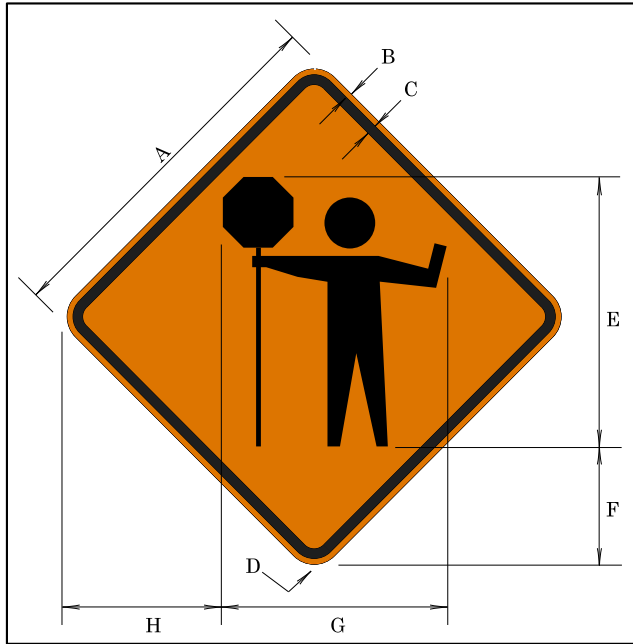

Table 180: Sign CW23-2 (Flagger Ahead) Dimensions (inches)

Sign Type	A	B	C	D	E	F	G	H
Minimum	36	0.625	0.875	2.25	24	12.25	20	16
Standard	48	0.75	1.25	3	36	14.75	30	20

Sign Background: Fluorescent orange, standard retroreflective sheeting.

Sign Legend: Black, non-reflective sheeting.

The Flagger Ahead symbol sign may be used as an alternate to the Flagger Ahead symbol sign W20-7a shown in the MUTCD. For ODOT highway construction contracts (maintenance, utility, and permit work), do not use the W20-7a sign.

The Flagger Ahead symbol sign shall also be used to warn motorists of an automated flagger assistance device (AFAD) when used in a work zone.

The state traffic engineer approved the CW23-2 (Flagger Ahead) sign in May 1998. The sign was last updated in July 2014.

# CW23-6

Figure 183: CW23-6 (PASSING LANE CLOSED AHEAD) Detail

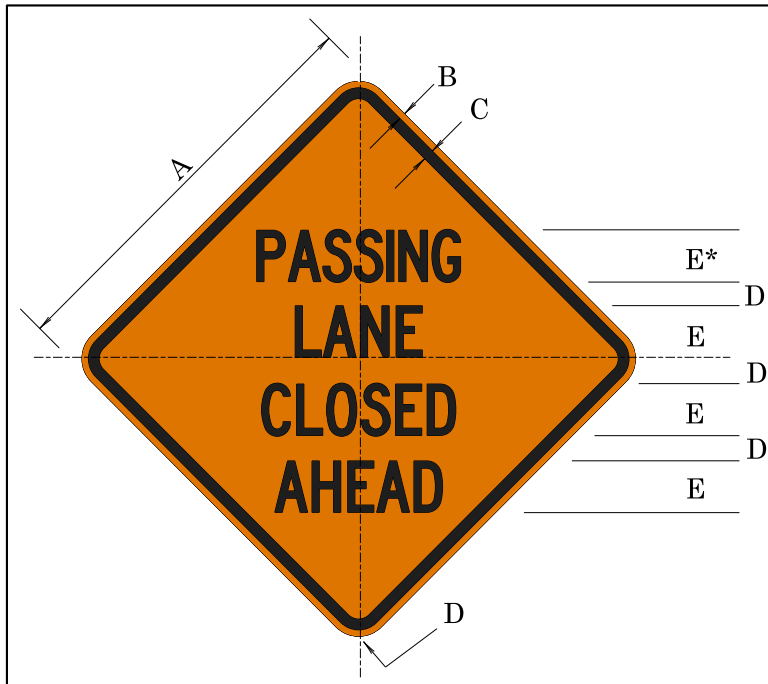

Table 181: CW23-6 (PASSING LANE CLOSED AHEAD) Dimensions (inches)

<b>A</b>	<b>B</b>	<b>C</b>	<b>D</b>	<b>E</b>
48	0.75	1.25	3	6C

Sign Background: Fluorescent orange, standard retroreflective sheeting.

Sign Legend: Black, non-reflective sheeting.

The PASSING LANE CLOSED AHEAD sign should be used to warn the motorist of this condition.

The OTC approved the CW23-6 (PASSING LANE CLOSED) sign in January 1990. The sign was last updated in July 2014.



# CW23-7

Figure 184: Sign CW23-7 (TRUCKS ENTERING HIGHWAY XXXX FT.) Detail

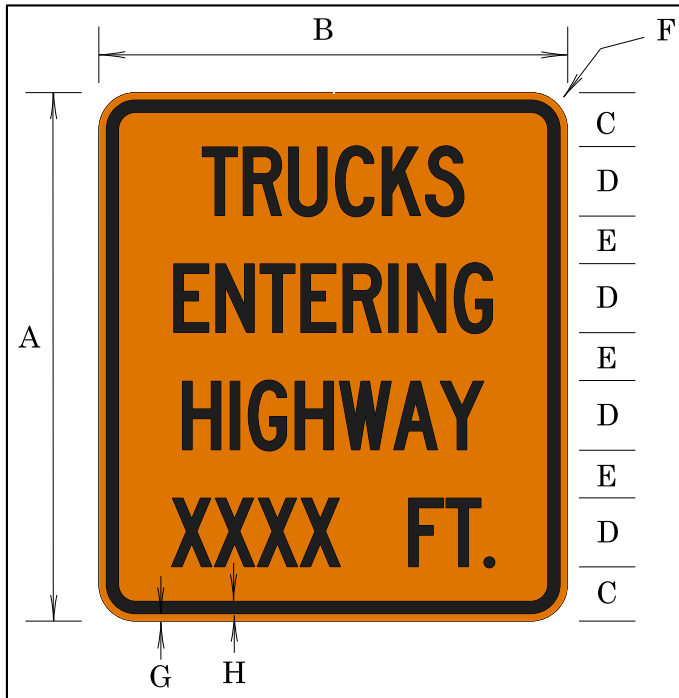

Table 182: Sign CW23-7 (TRUCKS ENTERING HIGHWAY XXXX FT.) Dimensions (inches)

A	B	C	D	E	F	G	H
54	48	5.5	7C	5	3	0.75	1.25

Sign Background: Fluorescent orange, standard retroreflective sheeting.

Sign Legend: Black, non-reflective sheeting.

The TRUCKS ENTERING HIGHWAY XXXX FT. sign should be used to warn motorists of trucks entering the highway at places other than a normal intersection.

The OTC approved the CW23-7 (TRUCKS ENTERING HIGHWAY XXXX FT.) sign in June 1990. The sign was last updated in July 2014.

# CW23-8

Figure 185: Sign CW23-8 (TRUCKS LEAVING HIGHWAY XXXX FT.) Detail

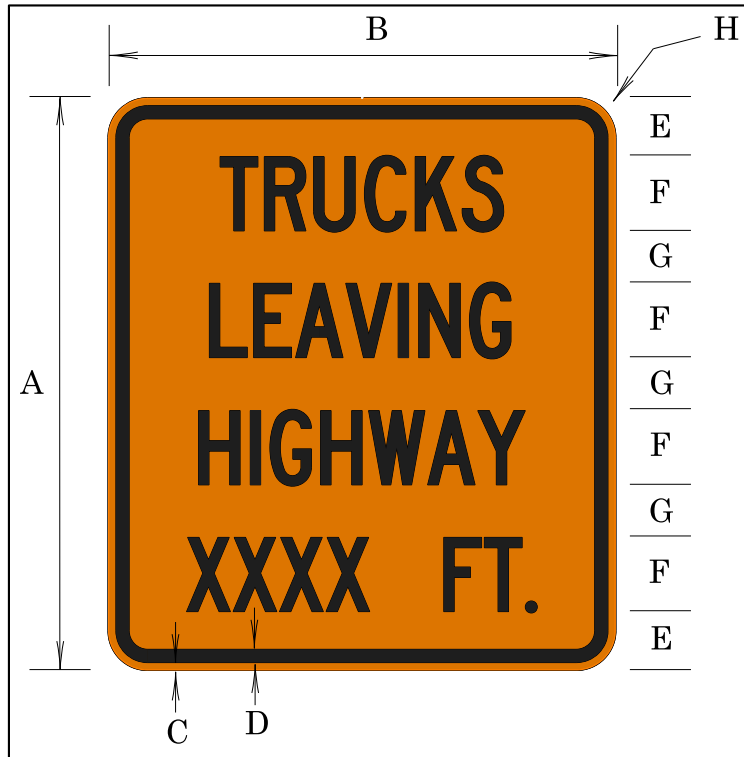

Table 183: Sign CW23-8 (TRUCKS LEAVING HIGHWAY XXXX FT.) Dimensions (inches)

A	B	C	D	E	F	G	H
54	48	0.75	1.25	5.5	7C	5	3

Sign Background: Fluorescent orange, standard retroreflective sheeting.

Sign Legend: Black, non-reflective sheeting.

The TRUCKS LEAVING HIGHWAY XXXX FT. sign should be used to warn motorists of trucks leaving the highway at places other than a normal intersection.

The OTC approved the CW23-8 (TRUCKS LEAVING HIGHWAY XXXX FT.) sign in June 1990. The sign was last updated in July 2014.

# CW23-12

Figure 186: Sign CW23-12 (LEFT TURN LANE CLOSED AHEAD) Detail

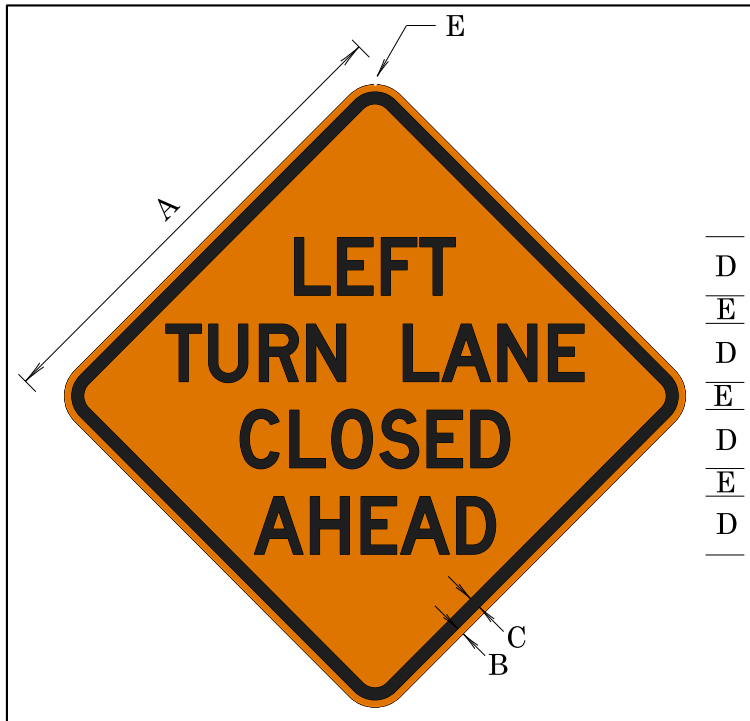

Table 184: Sign CW23-12 (LEFT TURN LANE CLOSED AHEAD) Dimensions (inches)

A	B	C	D	E
48	0.75	1.25	6D	3

Sign Background: Fluorescent orange, standard retroreflective sheeting.

Sign Legend: Black, non-reflective sheeting.

The LEFT TURN LANE CLOSED AHEAD sign may be used to warn motorists they cannot use a left turn lane ahead. Use this sign as the advance warning for the LEFT TURN LANE CLOSED sign when spacing allows.

The state traffic engineer approved the CW23-12 (LEFT TURN LANE CLOSED AHEAD) sign in October 2002. The sign was last updated in July 2014.

# CW23-13

Figure 187: Sign CW23-13 (LEFT TURN LANE CLOSED) Detail



Table 185: Sign CW23-13 (LEFT TURN LANE CLOSED) Dimensions (inches)

A	B	C	D	E	F	G
48	0.75	1.25	6D	4	5	3

Sign Background: Fluorescent orange, standard retroreflective sheeting.

Sign Legend: Black, non-reflective sheeting.

The LEFT TURN LANE CLOSED sign should be used where construction activities require the closing of a left turn lane. The LEFT TURN LANE CLOSED AHEAD sign (CW23-12) should be used as an advance warning, allowing motorists to think of alternate routes prior to reaching the LEFT TURN LANE CLOSED sign.

The state traffic engineer approved the CW13-13 (LEFT TURN LANE CLOSED) sign in October 2002. The sign was last updated in July 2014.

# CW23-14

Figure 188: CW23-14 (CONSTRUCTION VEHICLE DO NOT FOLLOW) Detail

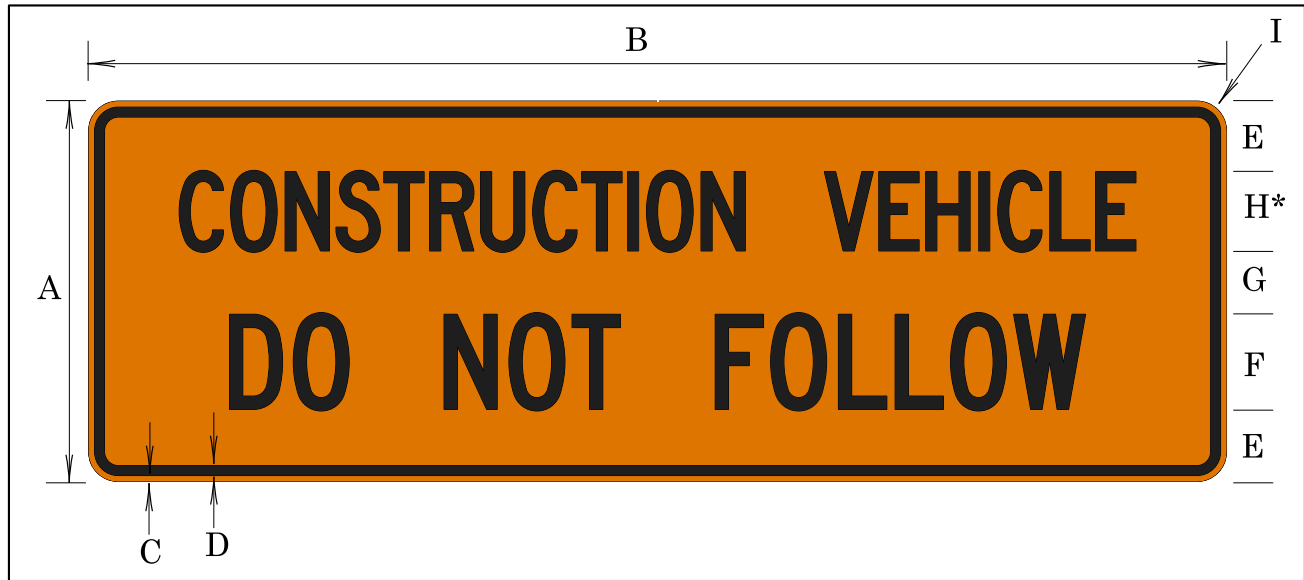

Table 186: CW23-14 (CONSTRUCTION VEHICLE DO NOT FOLLOW) Dimensions (inches)

A	B	C	D	E	F	G	H	I
24	72	0.375	0.625	4.5	6C	4	5C	1.5

\*Letter spacing reduced by 20%

Sign Background: Fluorescent orange, standard retroreflective sheeting.

Sign Legend: Black, non-reflective sheeting.

The CONSTRUCTION VEHICLE DO NOT FOLLOW sign may be used on the back of a construction vehicle to discourage motorists from following it out of the travel lane into a work area. A typical application: on asphalt trucks participating in paving operations.

The CONSTRUCTION VEHICLE/DO NOT FOLLOW sign shall be mounted on a rigid substrate.

The state traffic engineer approved the CW23-14 (CONSTRUCTION VEHICLE DO NOT FOLLOW) sign in January 2005. The sign was last updated in July 2014.

## **Chapter 7: School Area Signs**

### **Sign Color for School Warning Signs (MUTCD 7B.07)**

All new school-related warning signs shall be fluorescent yellow-green sheeting.

ODOT policy is to reserve the use of fluorescent yellow-green sign sheeting for school warning signs on state highways, including the “SCHOOL” portion of the School Speed Limit (S5-1) sign and any supplemental plaques used in association with these warning signs. Pedestrian and/or bicycle warning signs should use the standard yellow color. Fluorescent yellow sign sheeting may be used for pedestrian and/or bicycle crossing signs, if there is a need to call extra attention to a particular crossing.

The region traffic engineer may allow the use of fluorescent yellow-green for pedestrian/bicycle warning signs on a state highway, if the requesting jurisdiction can demonstrate an existing systematic approach to pedestrian signing which includes the fluorescent yellow-green sign background. However, other treatments must be considered before choosing fluorescent yellow-green sign sheeting (e.g. curb extensions, pedestrian refuge islands, rapid flash beacons, etc.).

The mixing of standard yellow and fluorescent yellow-green backgrounds for pedestrian/bicycle signs within a selected site area should be avoided.

### **School Zone Sign and Plaques and End School Zone Sign (S1-1, S4-3P, S4-7P, & S5-2) (MUTCD 7B.09)**

At each location a jurisdiction wishes to establish a school zone, a School Zone sign (S1-1) shall be installed. A school zone can be established with or without a reduced school speed limit. Oregon Revised Statute defines school zones as:

#### **801.462 “School zone.”**

(1) “School zone” means both of the following:

- a. A specific segment of highway that is adjacent to school grounds and that is marked by signs described in subsection (2) of this section.
- b. A crosswalk that is not adjacent to school grounds and that is marked by signs described in subsection (2) of this section.

(2) Signs marking a school zone may include any words, symbols or combination of words and symbols that gives notice of the presence of the school zone. [2003 c.397 §2]

The END SCHOOL ZONE sign (S5-2) shall be used to make the end of a school zone when using the FINES HIGHER signing.

## **Higher Fines Zone Signs (MUTCD 7B.10)**

A BEGIN HIGHER FINES ZONE (R2-10) sign or a FINES HIGHER (R2-6P) plaque may be posted in school zones where WHEN FLASHING or WHEN CHILDREN ARE PRESENT supplemental plaques are also used. Requests and funding for sign installations shall be through the school district.

Where a BEGIN HIGHER FINES ZONE (R2-10) sign or a FINES HIGHER (R2-6P) plaque is posted, an END SCHOOL ZONE sign shall be installed on the downstream end of the zone to notify users of the termination of the increased fines zone.

## **School Advance Crossing Assembly (MUTCD 7B.11)**

The School Advance Crossing Assembly signs may be omitted in advance of a school crossing.

## **School Crossing Assembly (MUTCD 7B.12)**

An Overhead Pedestrian Crossing Sign (R1-9a) may be used to remind road users of the state law to stop for pedestrians. The sign may be modified to replace the standard pedestrian symbol with the standard school children symbol. The sign may be used at un-signalized school crossings.

Figure 189: Overhead Pedestrian Crossing Sign (R1-9a)



If the overhead signs are mounted in combination with flashing beacons, the flashing beacons shall not continuously flash (24 hr./day) if the following is true:

The overhead flashing beacons are in a school zone with flashing beacons operated periodically during the day to indicate when children are scheduled to arrive or leave school.

Flashing beacons, when used, shall be on the same assembly as the WHEN FLASHING plaque (S4-4P).

## **School Speed Limit Assembly (S4-1, S4-2, S4-3, S4-4, S4-6, & S5-1) and End School Speed Limit Sign (S5-3) (MUTCD 7B.15)**

When a 20-mph school speed zone is established in accordance with ORS 811.111, the School Speed Limit Assembly shall be used. **Oregon Revised Statutes specify two conditions under which different supplemental plaques may be used on the School Speed Limit Assembly** (shown on the following page).

A 36" School Speed Limit assembly shall be used on all 4-lane highways and rural highways. A 24" assembly may be used on urban 2-lane streets.

The beginning point of the reduced school speed limit should be at least 200 feet in advance of school grounds or a school crossing, unless otherwise determined by engineering study.

Use the END SCHOOL SPEED LIMIT Sign (S5-3) unless a FINES HIGHER Sign is used. If using a FINES HIGHER Sign, an END SCHOOL ZONE Sign (S5-2) shall be used.

## **Reduced Speed School Zone Ahead Sign (S4-5 & S4-5a) (MUTCD 7B.16)**

In areas where the posted speed is 35 mph or higher, a REDUCED SPEED SCHOOL ZONE AHEAD (S4-5) sign may be used. If used, this sign should be placed 150 to 250 feet prior to the School Zone (S1-1) sign.

## **General Information**

For recommendations and guidance on the appropriate use and locations of signs in school zones, use the ODOT Traffic-Roadway Section publication "A Guide to School Area Safety," with the layouts provided on figures 194 -199.



## School Zone Conditions

Figure 190: School Zone Condition A (Adjacent to School Grounds)



Figure 191: School Zone Condition B (Crosswalk/Non-adjacent to School Grounds)



## School Zone Signing Layouts

Standard signing layouts for school zones are shown in figures 194-199. All school zone signing shall follow the standards on these pages.

Figure 192: Overhead School Crossing Sign (Optional)

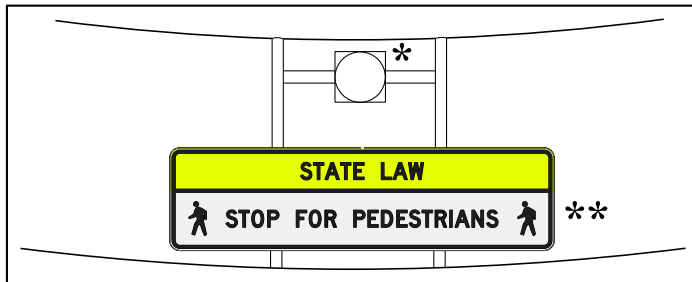

\*Continuously flashing (24 Hrs./day) overhead beacons, as shown here, shall not be used in school zones with WHEN FLASHING sign assemblies.

\*\*The Overhead Ped Crossing sign may be modified to replace the standard pedestrian symbol with the standard school children symbol (from S1-1).

Figure 193: Ground-Mounted Overhead School Crossing Sign (Optional)

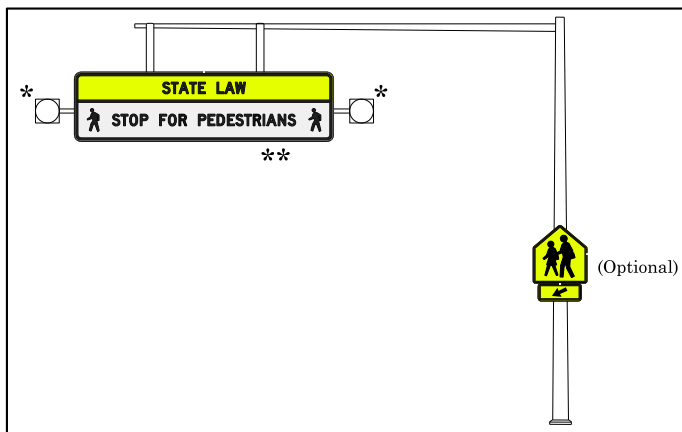

Note: The Overhead Pedestrian Crossing (R1-9a) sign shown here is optional and may be supplemented with the standard ground-mounted School Crosswalk Warning Assembly (S1-1 with diagonal arrow).

Note: Existing overhead installations using either the School (S1-1) sign or the School Crossing sign with crosswalk lines (S2-1 from the 1988 MUTCD) may remain in place for the duration of their service life, at which time they must be replaced with the Overhead Pedestrian Crossing (R1-9a) sign.

The state traffic engineer approved these signs in May 2004. The sign was last updated in May 2012.

Figure 194: Condition "A" Layout without School Crosswalk

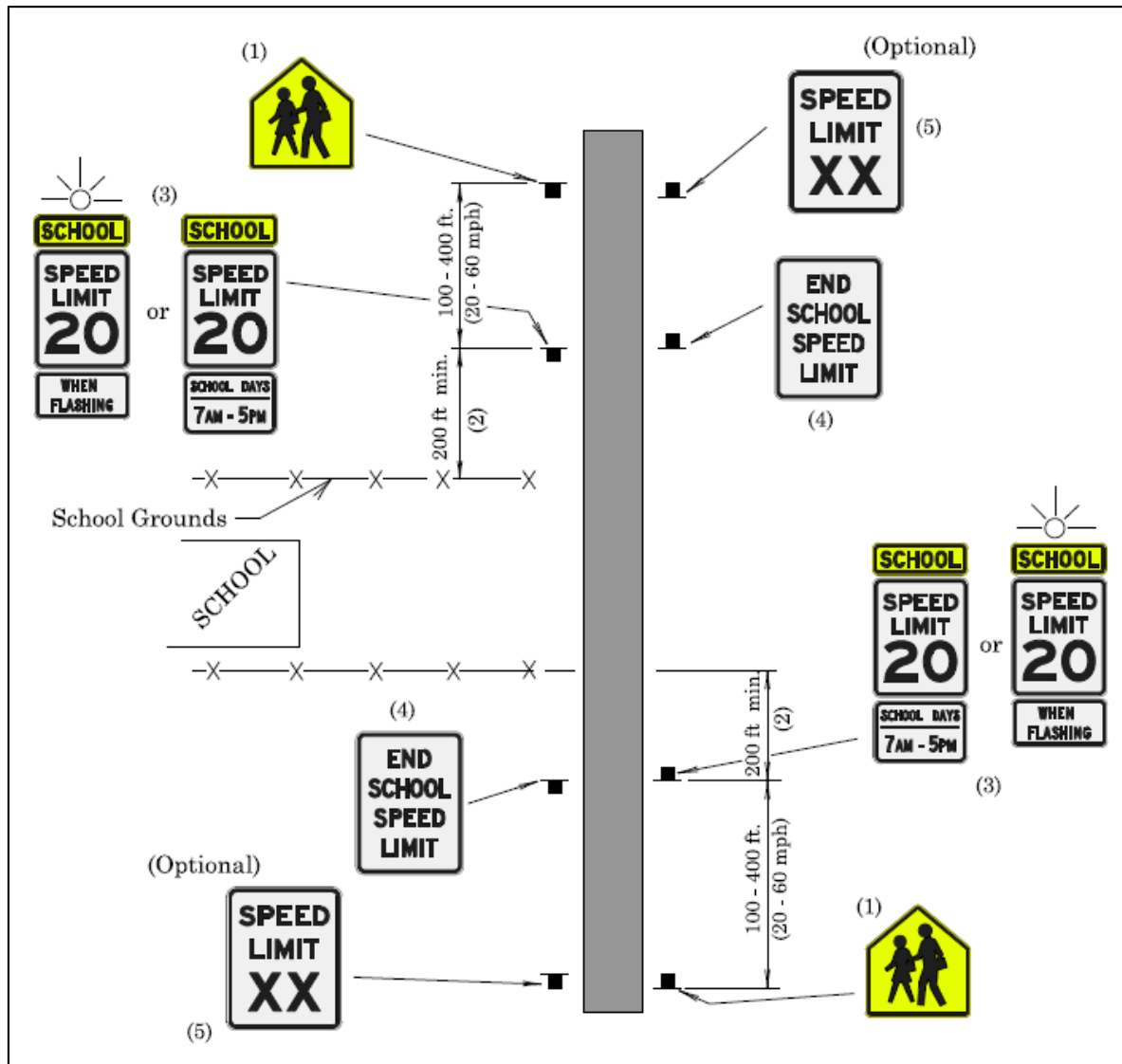

1. SCHOOL/FINES HIGHER sign assemblies may be used in Condition "A" school zones only with SCHOOL/SPEED LIMIT 20/WHEN FLASHING sign assemblies.
2. Locate the SCHOOL/SPEED LIMIT 20 sign assembly at the beginning of the school speed zone. This location is typically 200 feet min. from the school grounds, or as established by an engineering study.

3. Use of a rear-facing flasher is optional for situations where side road traffic enters from within the designated school zone. See standard detail DET 4416 for more information on rear-facing flasher units.
4. Use END SCHOOL ZONE sign for zones that include FINES HIGHER signing. Otherwise, use the END SCHOOL SPEED LIMIT sign.
5. SPEED LIMIT XX sign may instead be installed at the same location as, and on the same support with, the END SCHOOL SPEED LIMIT sign.

The state traffic engineer approved this layout in May 2004. The layout was last updated in May 2012.

Figure 195: Condition "A" Layout with School Crosswalk

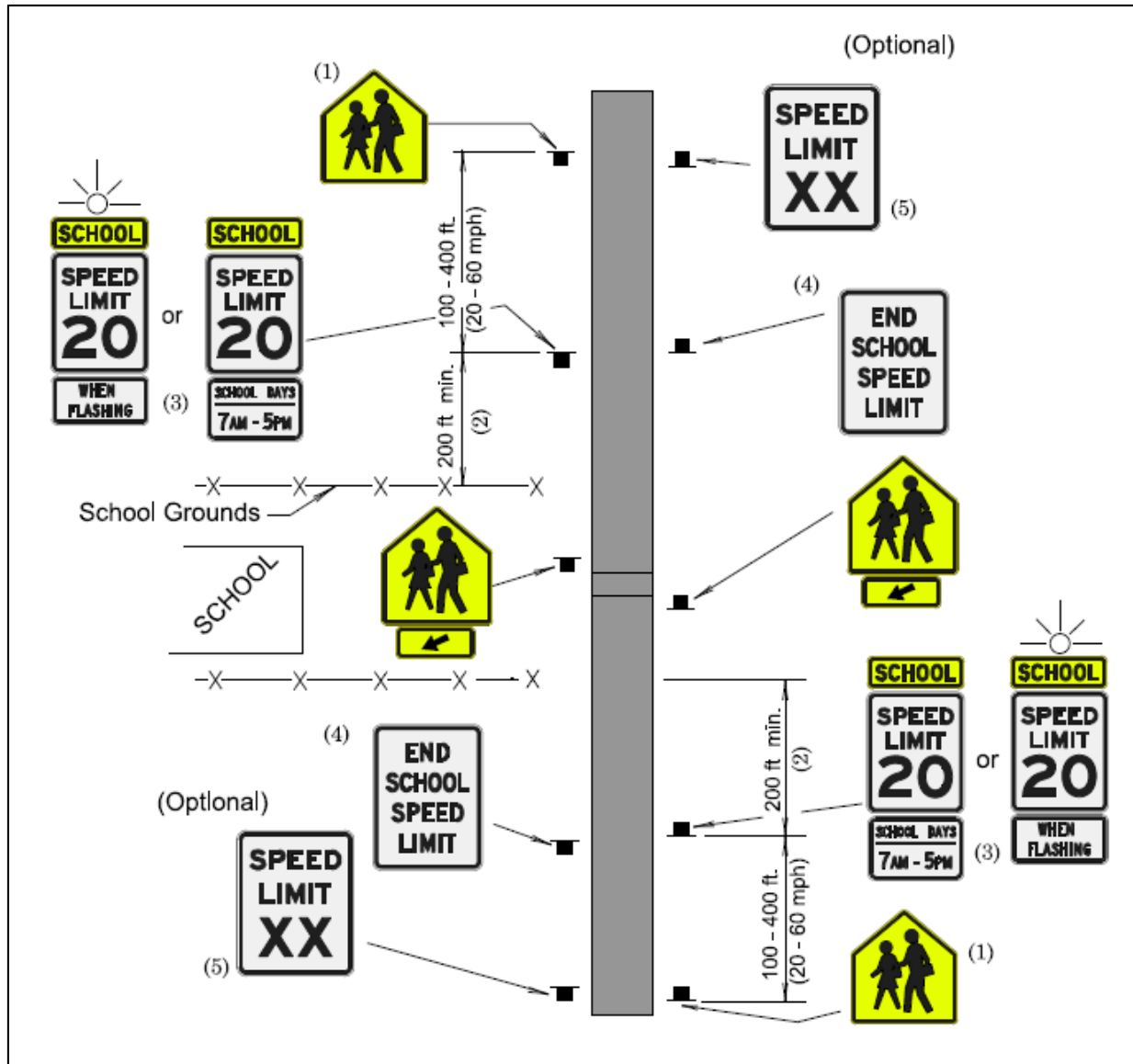

1. SCHOOL/FINES HIGHER sign assemblies may be used in Condition "A" school zones only with SCHOOL/SPEED LIMIT 20/WHEN FLASHING sign assemblies.
2. Locate the SCHOOL/SPEED LIMIT 20 sign assembly at the beginning of the school speed zone. This location is typically 200 feet min. from the school grounds or the school crosswalk, or as established by an engineering study.
3. Using a rear-facing flasher is optional for situations where side road traffic enters from within the designated school zone. See standard detail DET 4416 for more information on rear-facing flasher units.

4. Use END SCHOOL ZONE sign for zones that include FINES HIGHER signing. Otherwise use the END SCHOOL SPEED LIMIT sign.
5. SPEED XX OR SPEED LIMIT XX sign may instead be installed at the same location as, and on the same support with, the END SCHOOL SPEED LIMIT sign.

The state traffic engineer approved this layout in May 2004. The layout was last updated in May 2012.

Figure 196: Condition "B" School Crosswalk Not Adjacent To School Grounds

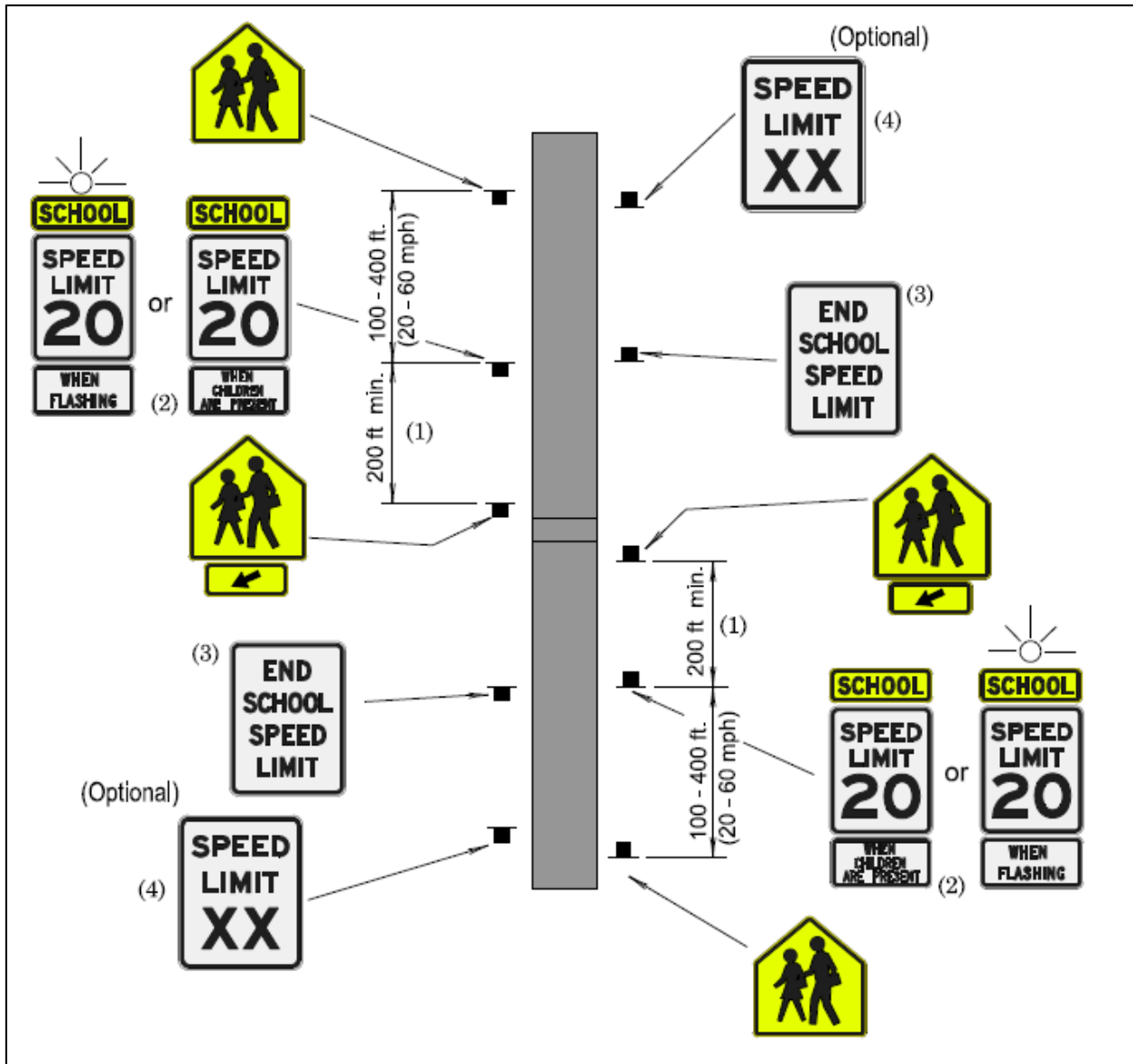

1. Locate the SCHOOL/SPEED LIMIT 20 sign assembly at the beginning of the school speed zone. This location is typically 200 feet min. from the school crosswalk, or as established by an engineering study.
2. Use of a rear-facing flasher is optional for situations where side road traffic enters from within the designated school zone. See standard detail DET 4416 for more information on rear-facing flasher units.
3. Use END SCHOOL ZONE sign for zones that include FINES HIGHER signing. Otherwise use the END SCHOOL SPEED LIMIT sign.

4. SPEED XX or SPEED LIMIT XX sign may instead be installed at the same location as, and on the same support with, the END OF SCHOOL SPEED LIMIT sign.

The state traffic engineer approved this layout in May 2004. The layout was last updated in May 2012.



Figure 197: School Crosswalk Away From School at Signalized Intersection (Optional)

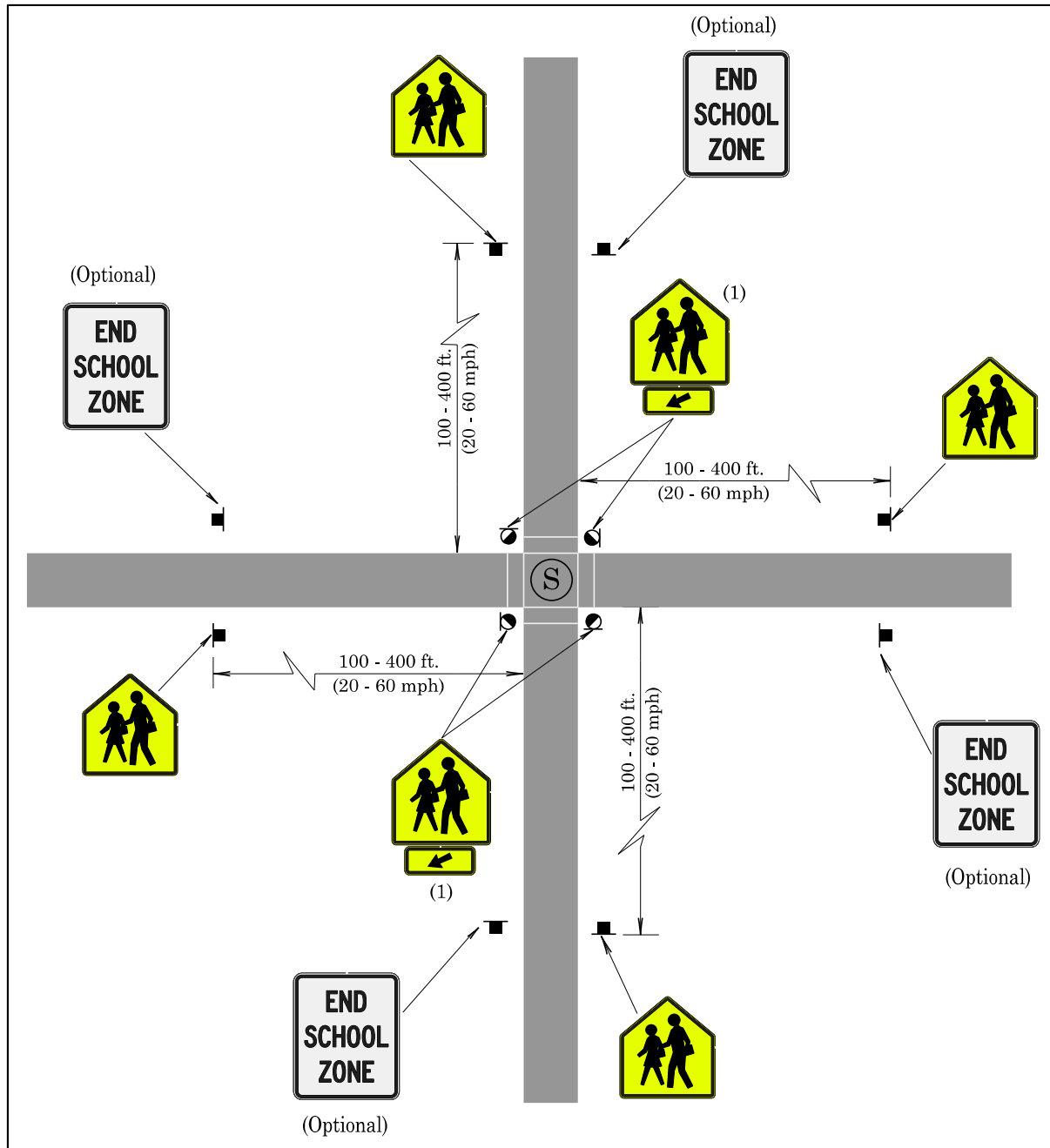

1. Use only at established school crossings, if engineering study determines need for signs.

The state traffic engineer approved this layout in July 1999. The layout was last updated in May 2012.

Figure 198: School Building Away From Highway or School Grounds Fenced (Optional)

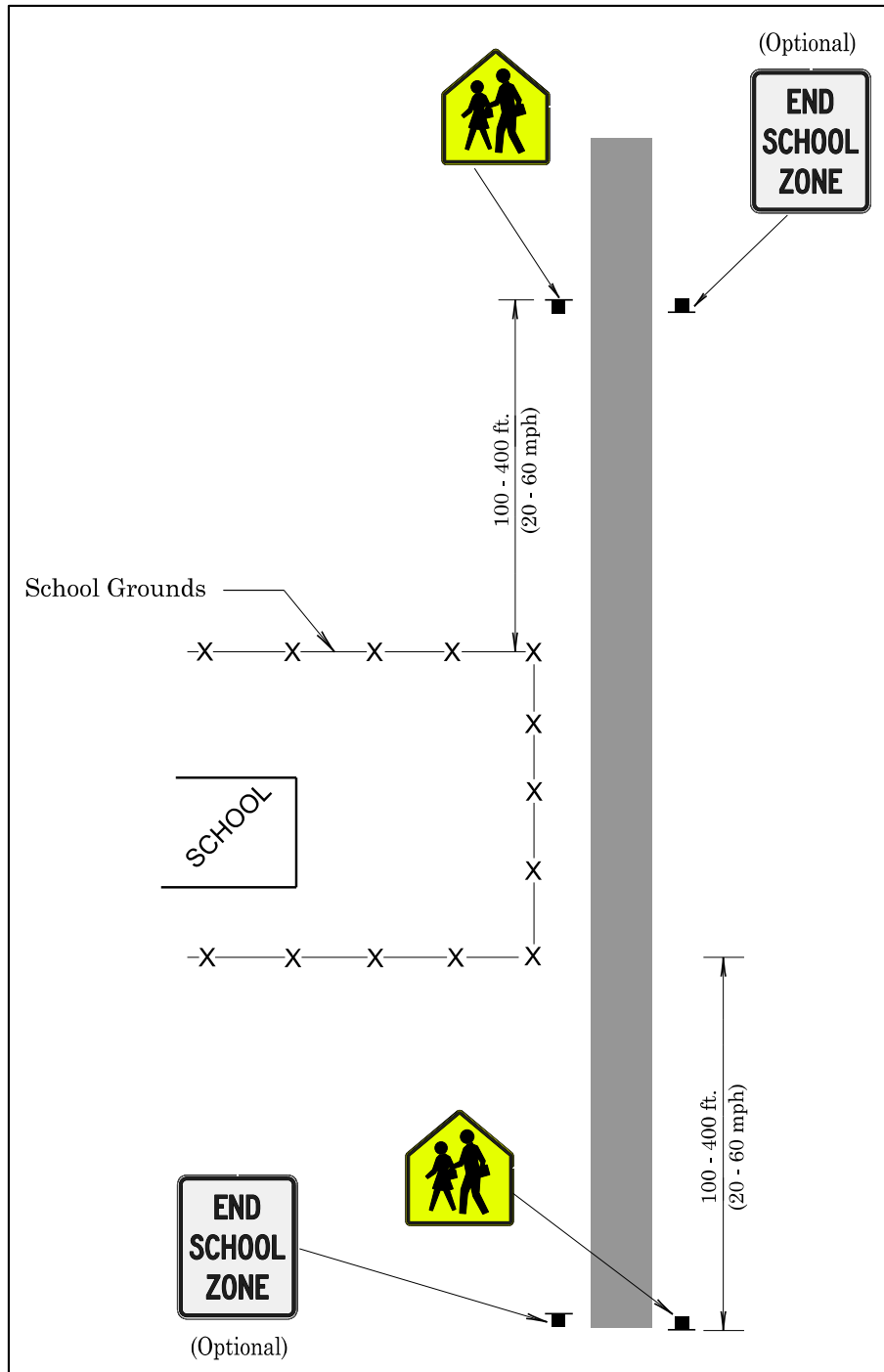

The state traffic engineer approved this layout in May 2004. The layout was last updated in May 2012.

Figure 199: School Crosswalk Away From School (Optional)

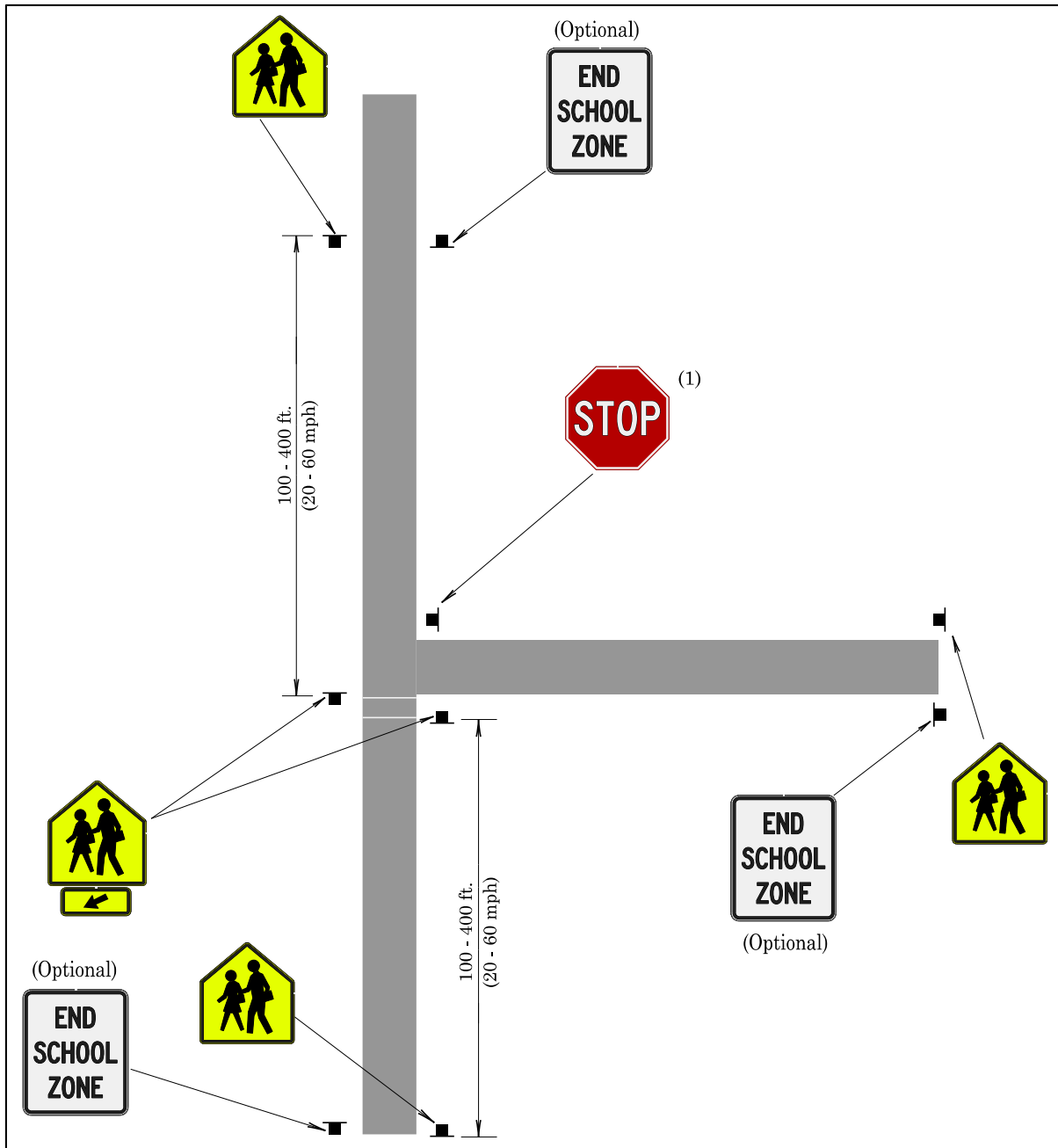

1. School Crossing Assembly shall not be used at approaches controlled by STOP.

Note: For further guidance and recommendations on the location and use of School Advance Warning Assemblies and School Speed Limit Assemblies, consult ODOT Traffic Engineering publication "A Guide to School Area Safety."

The state traffic engineer approved this layout in March 2006. The layout was last updated in May 2012.

# Oregon School Area Sign Details

## OS3-2

Please note: Do not use sign OS3-2 for new installations along state highways.

Figure 200: Sign OS3-2 (SCHOOL BUS TURN AROUND) Detail

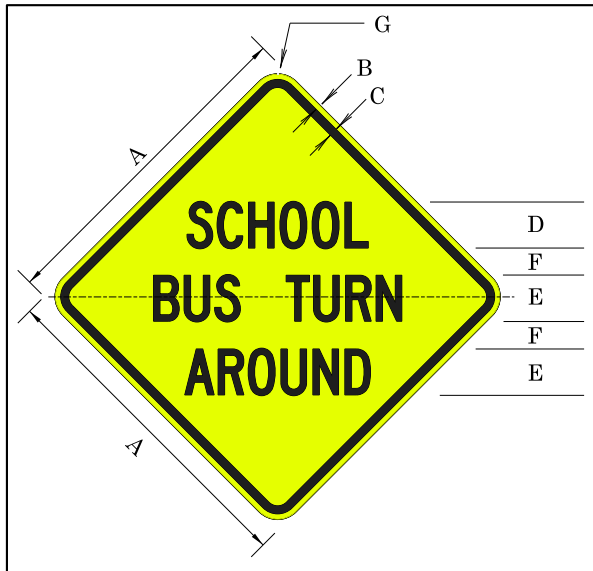

Table 187: Sign OS3-2 (SCHOOL BUS TURN AROUND) Dimensions (inches)

Sign Type	A	B	C	D	E	F	G
Minimum	30	0.5	0.75	4C	4C	2.5	1.875
Standard	36	0.625	0.875	5C	5C	3	2.25
Special	48	0.75	1.25	7C	7C	4	3

Sign Background: Fluorescent yellow-green, standard retroreflective sheeting.

Sign Legend: Black, non-reflective sheeting.

The SCHOOL BUS TURN AROUND sign may be used to warn motorists that school buses may be turning around and re-entering the roadway.

For state highways, use MUTCD sign S3-2.

The state traffic engineer approved the OS3-2 (SCHOOL BUS TURN AROUND) sign in January 2000. The sign was last updated in February 2016.

# OS4-8

Figure 201: Sign OS4-8 (SCHOOL DAYS with Time of Day) Detail

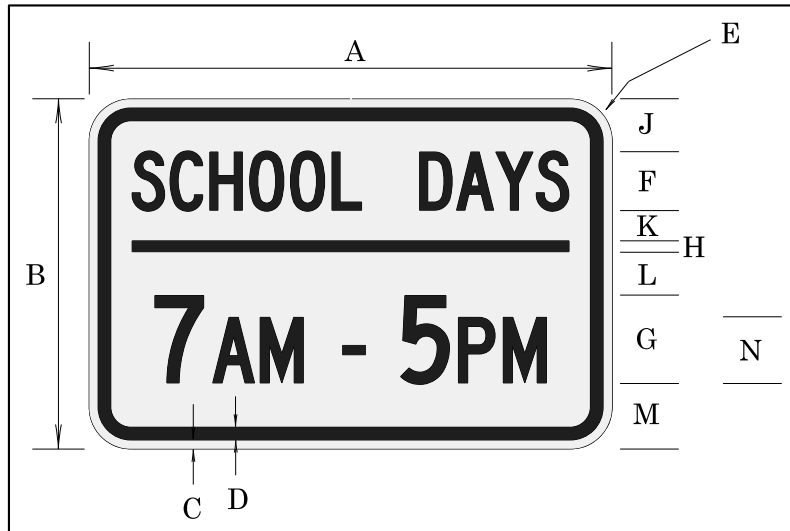

Table 188: Sign OS4-8 (SCHOOL DAYS with Time of Day) Dimensions (inches)

Sign Type	A	B	C	D	E	F	G	H	J	K	L	M	N
Minimum	24	18	0.375	0.625	1.5	2.5C	4C	0.5	3	2	2.5	3.5	3C
Standard	36	24	0.625	0.875	2.25	4C	6C	0.75	3.625	2.125	3	4.5	4.5C
Special	48	30	0.75	1.25	3	5C	8C	1	4.5	2.5	3.5	5.5	6C

Sign Background: White, standard retroreflective sheeting.

Sign Legend: Black, non-reflective sheeting.

The SCHOOL DAYS with Time of Day sign may be posted as part of a School Speed Assembly (with SCHOOL + SPEED LIMIT 20 signs) in specific school zones, in accordance with ORS 811.111. Limit the use of the SCHOOL DAYS with Time of Day sign to school zones on highways adjacent to school grounds (see [Condition "A"](#)).

The School Speed Assembly shall be located at the beginning of the designated school speed zone, based on an engineering investigation and according to the layouts shown in figures 194-199.

The special size sign shall be used only with region traffic manager approval.

The state traffic engineer approved the OS4-8 (SCHOOL DAYS with Time of Day) sign in May 2004. The sign was last updated in April 2006.

# OS4-9

Figure 202: Sign OS4-9 (SCHOOL IN SESSION) Detail

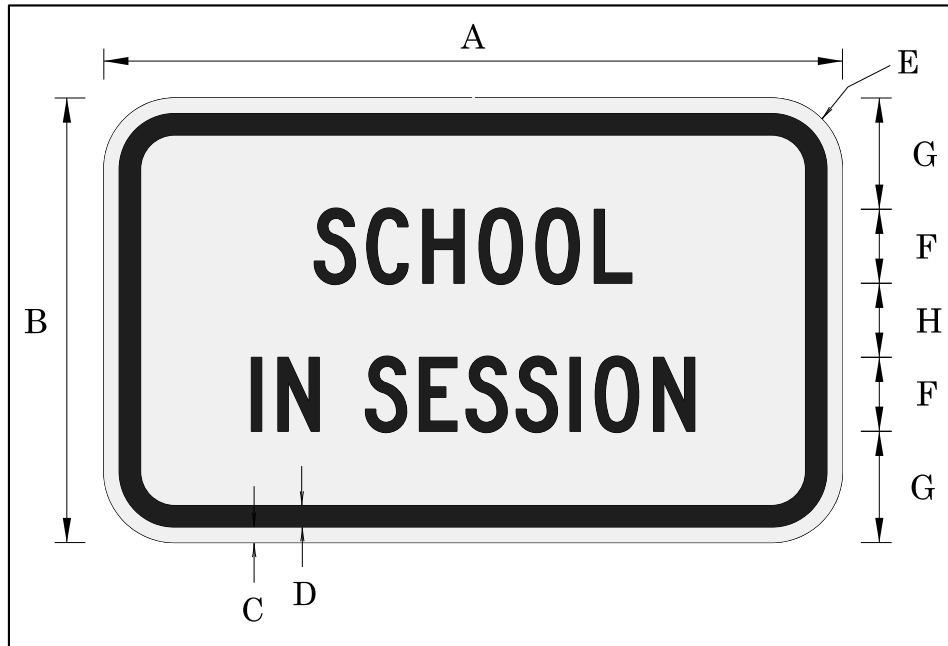

Table 189: Sign OS4-9 (SCHOOL IN SESSION) Dimensions (inches)

Sign Type	A	B	C	D	E	F	G	H
Minimum	30	18	0.625	0.875	2.25	6C	4.5	3
Standard	36	24	0.75	1.258	3	4C	6	4

Sign Background: White, standard retroreflective sheeting.

Sign Legend: Black, non-reflective sheeting.

The SCHOOL IN SESSION sign shall only be used in a school zone not marked by flashing beacons according to ORS 810.438.

The SCHOOL IN SESSION sign shall be installed as a supplemental sign below the TRAFFIC LAWS PHOTO ENFORCED sign (R10-18).

The SCHOOL IN SESSION supplemental sign shall be a minimum of 2 feet above the ground.

The state traffic engineer approved the OS4-9 (SCHOOL IN SESSION) sign in April 2010.

# OS5-5

Figure 203: Sign OS5-5 (SCHOOL SPEED LIMIT 20) Detail

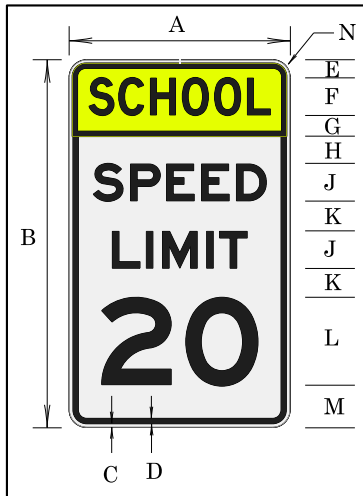

Table 190: Sign OS5-5 (SCHOOL SPEED LIMIT 20) Dimensions (inches)

Sign Type	A	B	C	D	E	F	G	H	J	K	L	M	N
Minimum	24	36	0.375	0.625	2	4D	1	3	4E	2	10E	4	1.5
Standard	36	60	0.625	0.875	4	6D	2.5	5.5	6E	5	14E	6	2.25
Special	48	72	0.75	1.25	4.5	8D	3	5.5	8E	6	16E	7	3

Sign Background: White, standard retroreflective sheeting.

School Panel Sign Background: Fluorescent yellow-green, standard retroreflective sheeting.

Sign Legend: Black, non-reflective sheeting.

Note: This sign shall only be installed with one of the following riders as appropriate, per ORS 811.111: WHEN FLASHING, WHEN CHILDREN ARE PRESENT, or SCHOOL DAYS/7 AM - 5PM.

Note: In lieu of three separate signs or an all-in-one School Speed Assembly, this SCHOOL/SPEED 20 combination sign may be used with a supplemental plaque to inform motorists of the speed limit in a designated school speed zone.

Locate the SCHOOL SPEED LIMIT 20 sign with supplemental plaque at the beginning of the designated school speed zone, based on an engineering investigation and according to the layouts shown in figures 194-199. The special size sign shall only be used with region traffic manager approval.

The state traffic engineer approved the OS5-5 (SCHOOL SPEED LIMIT 20) sign in May 2004. The sign was last updated in February 2016.



## **Chapter 8: Bicycle Signs**

### **Bicycle Warning and combined Bicycle/Pedestrian Signs (W11-1 & W11-15) (MUTCD 9B.18)**

The Bicycle Warning Sign (W11-1) may be used to advise motorists of the possible presence of bicycles on the roadway. The appropriate rider (“XING”, “ON ROADWAY”) should be included with all bicycle warning signs to indicate where the bicycles are likely to be encountered.

### **Other Bicycle Warning Signs (MUTCD 9B.19)**

The Traffic Engineering and Operations Section provides designs for the bicycle warning signs listed in the MUTCD that do not appear in the Standard Highway Signs Manual.

### **Bicycle Racing**

The Traffic Engineering and Operations Section provides designs for required signs listed in the “Guidelines for Administration of Bicycle Racing on Oregon Roads.” Also see designs for OBW16-2, W3-4, and W20-7.

### **Bicycle Routes**

The OREGON BIKE CENTENNIAL ROUTE sign should be removed from our highway system, as it is no longer supported by other organizations

See chapter 6 of this policy for additional bicycle warning signs for temporary events.

# Oregon Bicycle Sign Details

## OBR1-1

Figure 204: Sign OBR1-1 (Bicycle (Symbol) STOP symbol) Detail

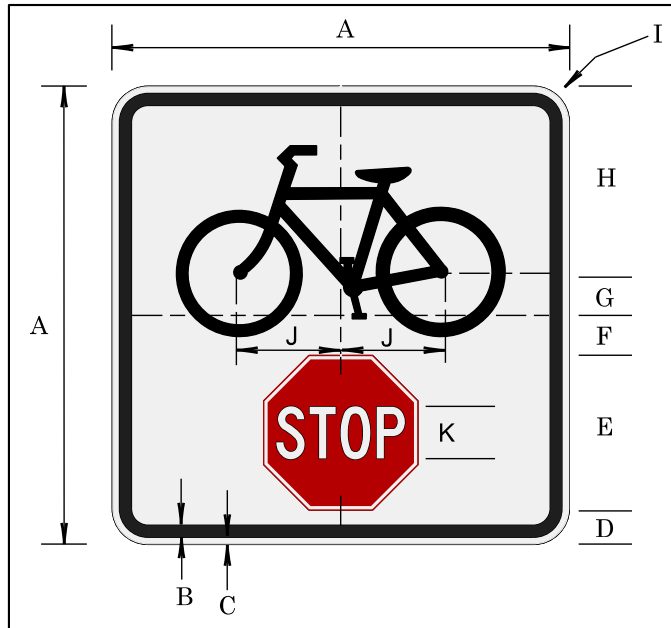

Table 191: Sign OBR1-1 (Bicycle (Symbol) STOP symbol) Dimensions (inches)

A	B	C	D	E	F	G	H	I	J	K
24	0.625	0.375	1.75	8	2.25	2	10	1.5	5.5	3C

Sign Background: White, standard retroreflective sheeting.

Bicycle Symbol Sign Legend: Black, non-reflective sheeting.

Stop Sign Legend: White, standard retroreflective sheeting.

Stop Sign Symbol: Red, standard retroreflective sheeting.

The Bicycle (Symbol) STOP symbol sign shall be used on bicycle paths at connections with roadways and roadway crossings where an 18" bicycle STOP sign (R1-1) could be visible to the motorist. At locations where the motorist cannot see the bicycle STOP sign, the R1-1 sign should be used.

The OTC approved the OBR1-1 (Bicycle (Symbol) STOP symbol) sign in January 1990. The sign was last updated in May 1998.

# OBR1-2

Figure 205: OBR1-2 (Bicycle (Symbol) YIELD) Detail

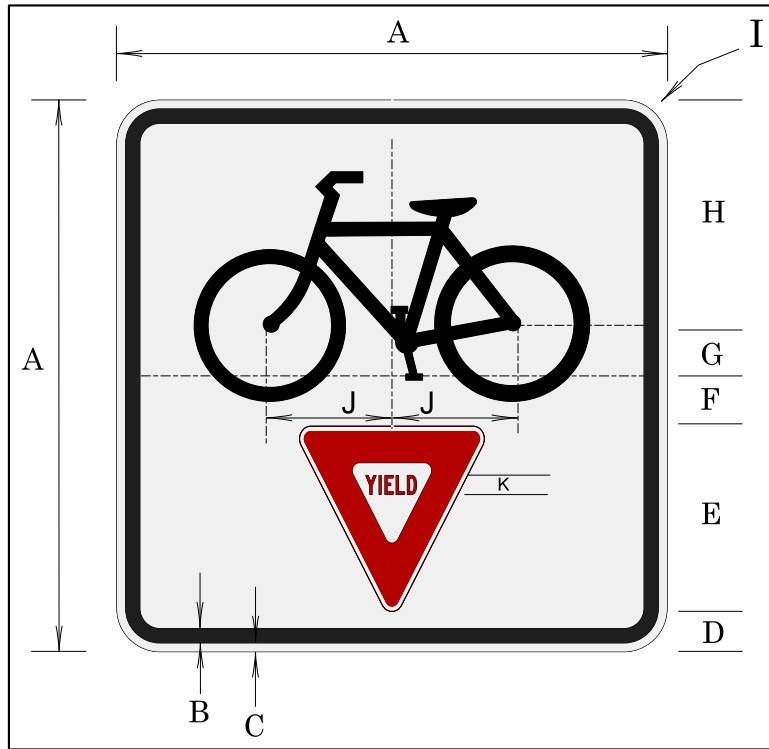

Table 192: OBR1-2 (Bicycle (Symbol) YIELD) Dimensions (inches)

A	B	C	D	E	F	G	H	I	J	K
24	0.625	0.375	1.75	8	2.25	2	10	1.5	5.5	1C

Sign Background: White, standard retroreflective sheeting.

Bicycle Symbol Sign Legend: Black, non-reflective sheeting.

Yield Sign Symbol: Red, standard retroreflective sheeting.

The Bicycle (Symbol) YIELD sign shall be used on bicycle paths at roadway connections with roadways and crossings where a 24" Bicycle YIELD sign (R1-2) could be visible to the motorist.

At locations where the motorists cannot see the bicycle YIELD sign, the (R1-2) sign should be used.

The OTC approved the OBR1-2 (Bicycle (Symbol) YIELD) sign in January 1990. The sign was last updated in May 2006.

# OBR10-13

Figure 206: Sign OBR10-13 (SIDEWALK USERS WALK BIKES) Detail

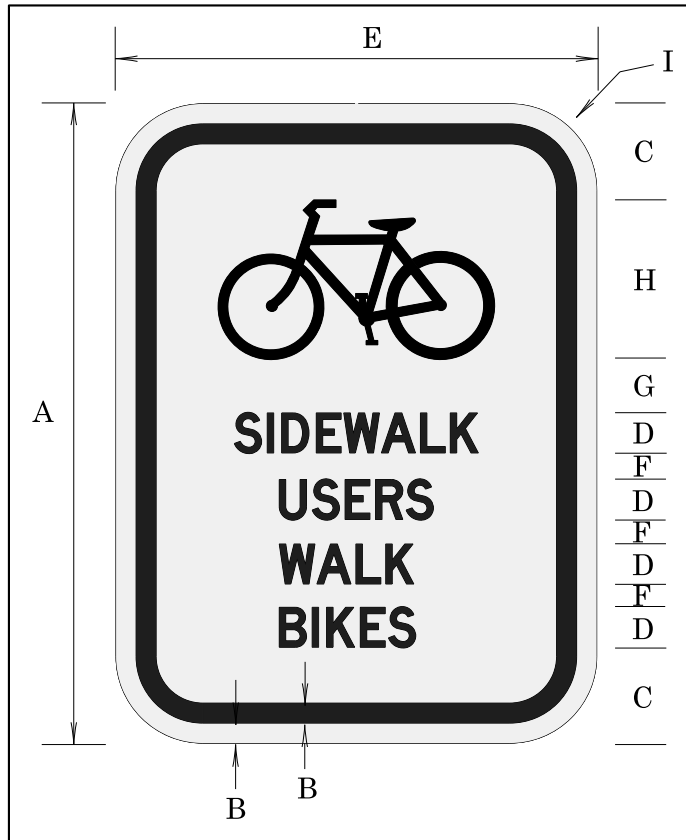

Table 193: Sign OBR10-13 (SIDEWALK USERS WALK BIKES) Dimensions (inches)

A	B	C	D	E	F	G	H	I
12	0.375	1.75	0.75D	9	0.5	1	3	1.25

Sign Background: White, standard retroreflective sheeting.

Sign Legend: Black, non-reflective sheeting.

The SIDEWALK USERS WALK BIKES sign may be used where winds or sidewalk width could make bicycle riding hazardous.

The OTC approved the OBR10-13 (SIDEWALK USERS WALK BIKES) sign in January 1990. The sign was last updated in May 2006.

# OBW1-8

Figure 207: Sign OBW1-8 (BIKES IN TUNNEL WHEN LIGHTS FLASH) Detail

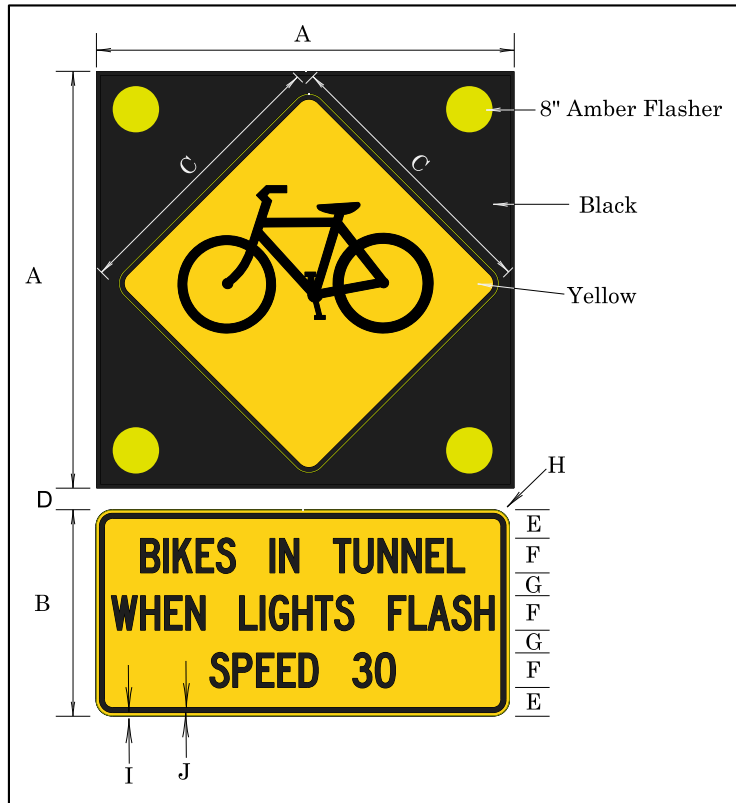

Table 194: Sign OBW1-8 (BIKES IN TUNNEL WHEN LIGHTS FLASH) Detail

A	B	C	D	E	F	G	H	I	J
72	36	48	2	5	6C	4	2.25	0.625	0.875

Sign Background: Yellow, standard retroreflective sheeting.

Upper Square Sign Background: Black, non-reflective sheeting.

Sign Legend: Black, non-reflective sheeting.

The BIKES IN TUNNEL WHEN LIGHTS FLASH sign shall be placed at tunnel entrances to warn the motorists they may encounter bikes in the tunnel.

Use 48" W11-1 Bike Warning Sign on a square non-reflective black background sign.

The OTC approved the OBW1-8 (BIKES IN TUNNEL WHEN LIGHTS FLASH) sign in May 1990. The sign was last updated in May 1998.

## OBW1-9

Figure 208: Sign OBW1-9 (Bike Lane Ends Symbol) Detail

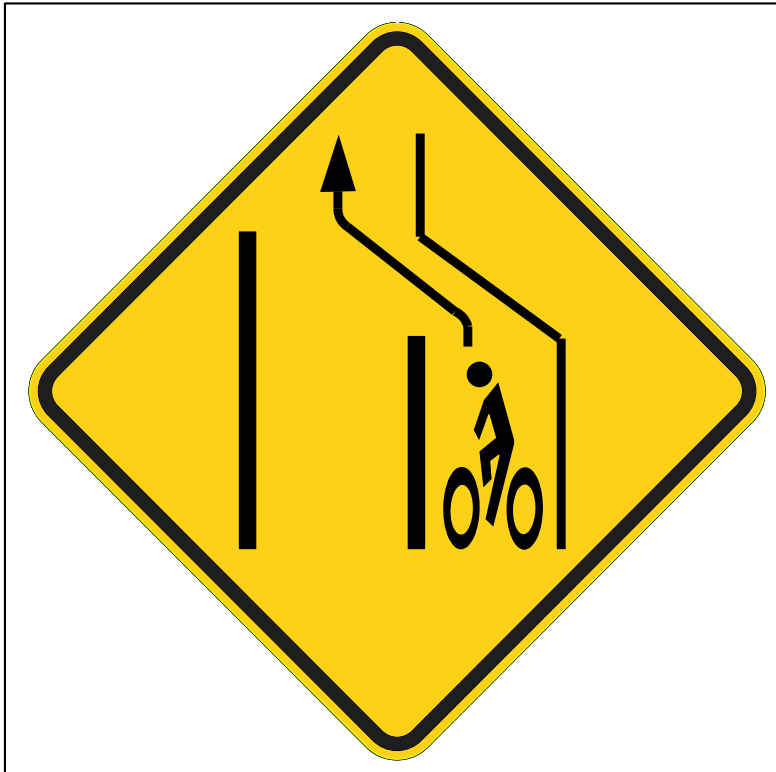

30" Minimum.

36" Standard.

Sign Background: Yellow, standard retroreflective sheeting.

Sign Legend: Black, non-reflective sheeting.

The Bike Lane Ends Symbol sign may be used where a bicycle lane is abruptly terminated and the rider must merge with the through lane of traffic.

The state traffic engineer approved the OBW1-9 (Bike Lane Ends Symbol) sign in February 1997. The sign was last updated in July 2014.

## OBW8-19L & OBW8-19R

Figure 209: Sign OBW8-19L & OBW8-19R (Bike Railroad Crossing Symbol) Detail

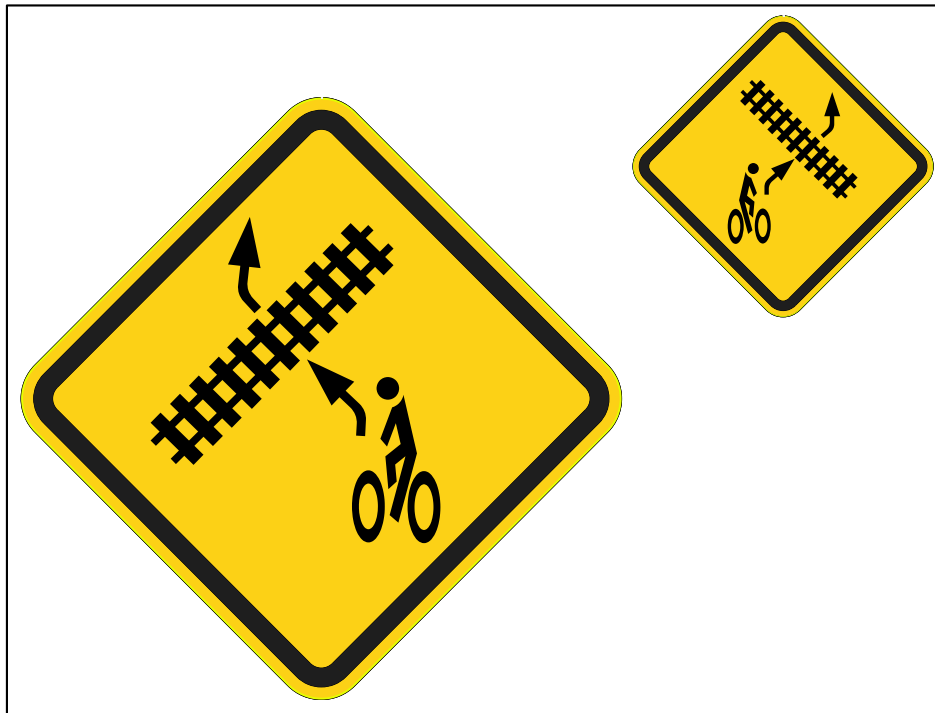

18" Standard.

Sign Background: Yellow, standard retroreflective sheeting.

Sign Legend: Black, non-reflective sheeting.

The Bike Railroad Crossing Symbol sign may be used where the path of the bicyclist crosses railroad tracks at an angle, which may create the potential to deflect a bicycle wheel.

The state traffic engineer approved the OBW8-19 L OBW8-19R (Bike Railroad Crossing Symbol) sign in January 2000. The sign was last updated in May 2006.

## OBW8-22

Not for use on state highways.

Figure 210: Sign OBW8-22 (Bike-Ped Warning) Detail



Available in 30", 36", and 48" sizes.

Sign Background: Yellow, standard retroreflective sheeting.

Sign Legend: Black, non-reflective sheeting.

The Bike-Ped Warning sign may be interchanged with the Bike Warning sign (W11-1) at, and in advance of, crossing locations where crossing activities will likely include pedestrians or cyclists.

When used at the crossing location, the sign shall be accompanied with the diagonal downward pointing arrow.

When used in advance of the crossing, it shall be accompanied with a supplemental plaque containing the legend AHEAD or XXX FEET.

For state highways, use MUTCD sign W11-15.

The state traffic engineer approved the OBW8-22 (Bike-Ped Warning) sign in March 1996. The sign was last updated in December 2011.



# OBW15-1

Figure 211: Sign OBW15-1 (SLOW (Bikes)) Detail

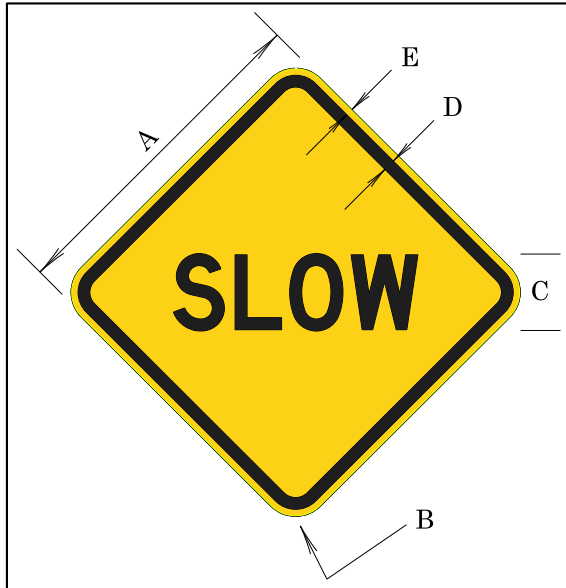

Table 195: Sign OBW15-1 (SLOW (Bikes)) Dimensions (inches)

A	B	C	D	E
18	1.5	4D	0.625	0.375

Sign Background: Yellow, standard retroreflective sheeting.

Sign Legend: Black, non-reflective sheeting.

The SLOW (Bikes) sign shall be restricted to locations on bicycle paths which require utmost caution and generally an appreciable reduction in speed by the bicyclist.

The OTC approved the OBW15-1 (SLOW (Bikes)) sign in January 1990. The sign was last updated in May 1998.

## OBD1-1c, OBD1-2c, & OBD1-3c

Figure 212: Sign OBD1-1c, OBD1-2c, & OBD1-3c Detail

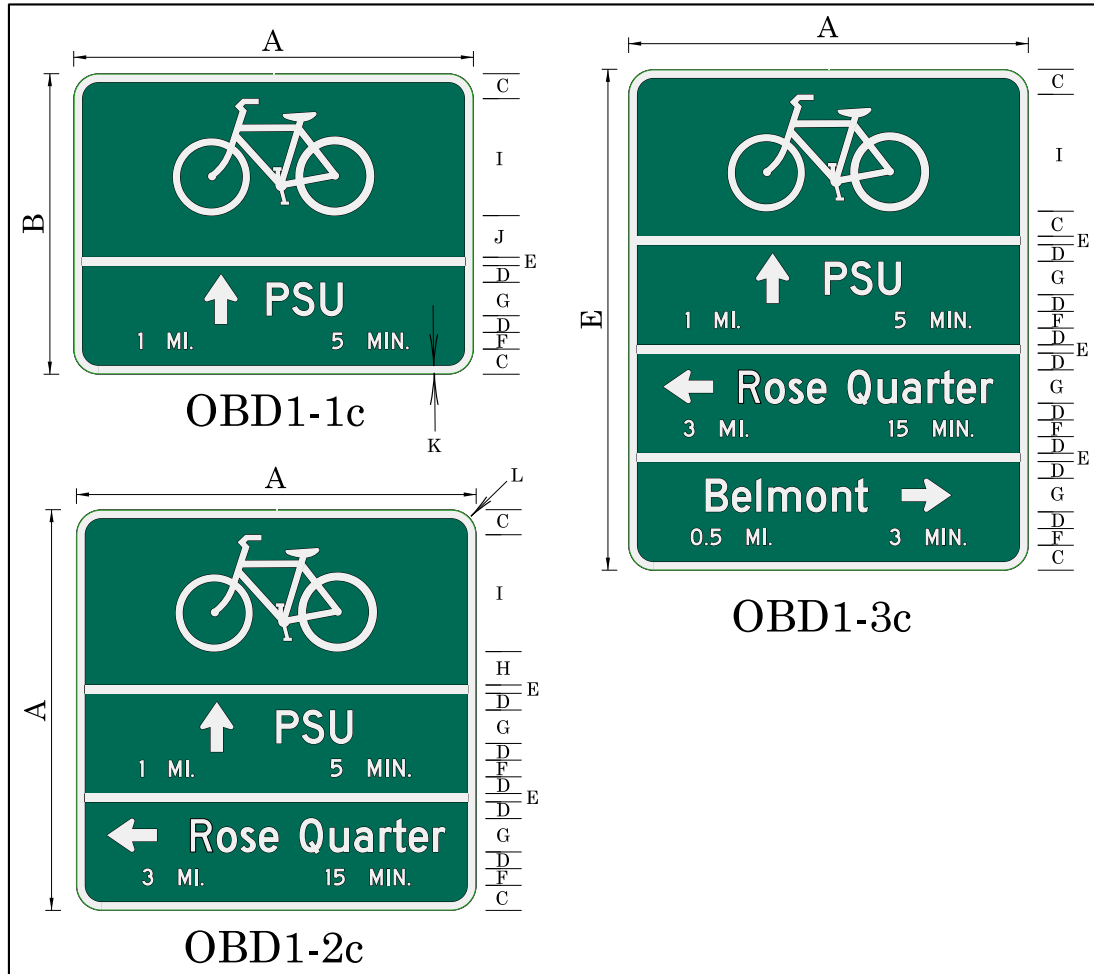

Table 196: Sign OBD1-1c, OBD1-2c, & OBD1-3c Dimensions (inches)

A	B	C	D	E	F	G	H	I	J	K	L
24	18	1.5	1	0.5	1D	2D	2	7	2.5	0.5	1.5

2" x 3" Arrows.

Sign Background: Green, standard retroreflective sheeting.

Sign Legend: White, standard retroreflective sheeting.

The bike directional signs can be used as a replacement for the D1-1c, D1-2c and D1-3c signs shown in the MUTCD.

The state traffic engineer approved the OBD1-1c, OBD1-2c, & OBD1-3c signs in July 2008. The sign was last updated in December 2011.

# OBD11-3

Figure 213: Sign OBD11-3 (OREGON COAST BIKE ROUTE) Detail

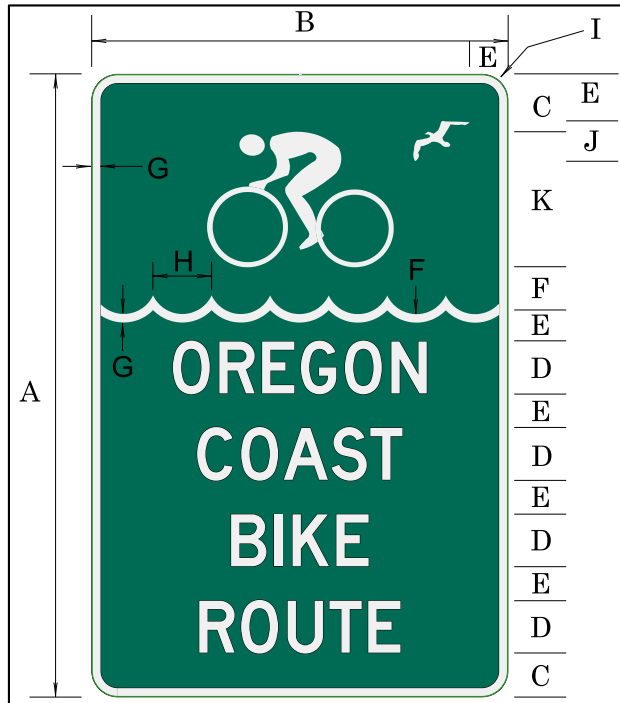

Table 197: Sign OBD11-3 (OREGON COAST BIKE ROUTE) Dimensions (inches)

A	B	C	D	E	F	G	H	I	J	K
36	24	2.5	3D	2	3	0.5	4	1.5	2.25	8

Sign Background: Green, standard retroreflective sheeting.

Sign Legend: White, standard retroreflective sheeting.

The OREGON COAST BIKE ROUTE sign should be used in lieu of any other bike route sign on the Oregon Coast Highway.

The OTC approved the OBD11-3 (OREGON COAST BIKE ROUTE) sign in June 1990. The sign was last updated in May 1998.

# OBD11-3a

Figure 214: Sign OBD11-3a (XXXX TRAIL) Detail

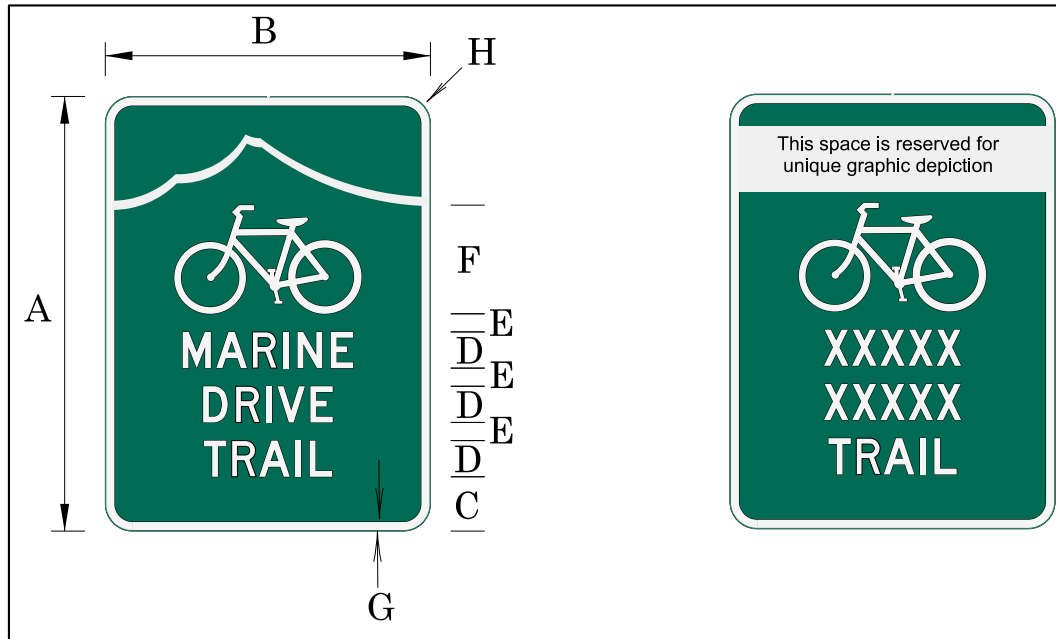

Table 198: Sign OBD11-3a (XXXX TRAIL) Dimensions (inches)

A	B	C	D	E	F	G	H
24	18	3	2D	1	6	0.5	1.5

Sign Background: Green, standard retroreflective sheeting.

Sign Legend: White, standard retroreflective sheeting.

The XXXX TRAIL bike sign may be used in lieu of any other bike route sign when used along an officially designated bike trail. Do not use it on state designated scenic bike routes (use OBM1-8).

Any graphic depiction at the top of the sign shall be consistent with the colors and design principles in the MUTCD. If used, the road authority shall approve the graphic depiction.

The state traffic engineer approved the OBD11-3a (XXXX TRAIL) sign in January 2014.

# OBM1-8 & OBM1-8a

Figure 215: Signs OBM1-8 & OBM1-8a (SCENIC BIKEWAY Route) Detail

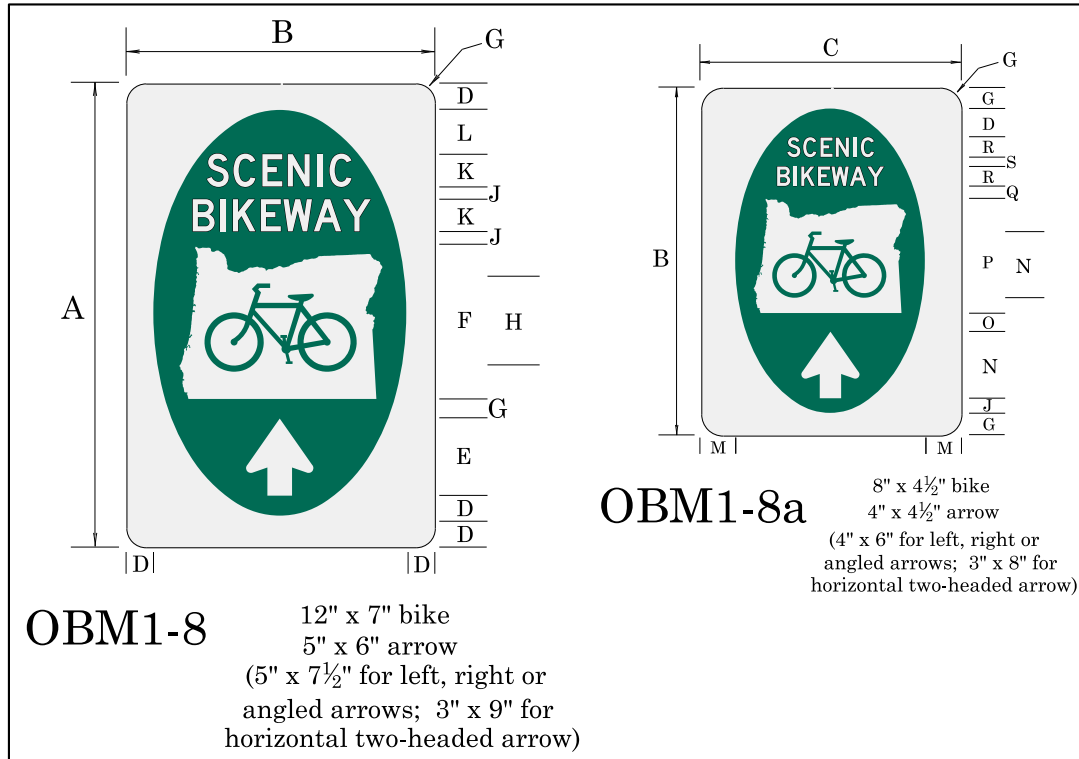

Table 199: Signs OBM1-8 & OBM1-8a (SCENIC BIKEWAY Route) Dimensions (inches)

A	B	C	D	E	F	G	H	J
36	24	18	2	6	12	1.5	7	1

K	L	M	N	O	P	Q	R	S
2.5D	3.5	2.5	4.5	1.25	8	0.75	1.5D	0.5

Sign Background: White, standard retroreflective sheeting.

Oval Sign Background: Green, standard retroreflective sheeting.

Letters, Arrow and State Sign Legend: White, standard retroreflective sheeting.

Bicycle Symbol: Green, standard retroreflective sheeting.

Note: Bike symbol should face right when arrow orientation is to the right.

The SCENIC BIKEWAY Route signs can be used in lieu of any other bike route sign, when it is used on a state designated bike route.

Use the 24" x 36" version (OBM 1-8) where the bike route is physically adjacent to or part of the highway. Use the 18" x 24" version (OBM 1-8a) where the bike route is physically removed from the highway.

The state traffic engineer approved the OBM1-8 & OBM1-8a (SCENIC BIKEWAY Route) sign in May 2005. The sign was last updated in January 2014.

# Appendix A: US Forest Service and ODOT Signing Agreement

The following items of agreement cover the signing portion of Memorandum of Understanding FS Agreement No. 18-MU-11062751-045 and ODOT Misc. Contracts & Agreements No. 32935, entered into June 21, 2018 by and between State of Oregon Department of Transportation (ODOT) and the USDA Forest Service (USFS), Pacific Northwest Region:

1. **Installing and Maintaining Signs.** ODOT has authority and responsibility for the installation and maintenance of all signs within the right of way/easement of the state highway system, except as noted in paragraph 3 in this section. All such signing will be in accordance with Oregon Standard Specifications, the Manual on Uniform Traffic Control Devices (MUTCD), the Oregon Supplements to the MUTCD, the “ODOT Sign Policy and Guidelines for the State Highway System” and Sign and Poster Guidelines for the Forest Service EM 7100-15 as appropriate.
2. **Signs Furnished by ODOT.** ODOT is financially responsible for and will furnish, install, and maintain guide signs within the right of way/easement as requested by the USFS and approved by ODOT, for the following sign categories (examples shown in Figure 216). Sign requests will be made to the ODOT district manager at least 60 calendar days in advance by the USFS forest supervisor. A proposed sign plan will be provided by the USFS showing the signs and their proposed locations. ODOT will review, modify, and approve or deny the request.
  - a. Approach signs for national forest administrative facilities such as ranger district and supervisor offices that provide public services or functions.
  - b. Junction signs for important national forest arterial routes
  - c. Directional signs to important destinations within the national forest. The following conditions apply:
    - i. Messages will be limited to no more than three destinations at any single location, using location names identified on public use maps.
    - ii. At areas where there are more than one agency’s facilities from one point on the highway, a generic recreation sign will be used with the represented agencies’ logos below the generic message.
    - iii. Up to four symbol plaques may be used on single destination signs, but they will not be used on generic multi-agency signs.
    - iv. Local road numbers as well as agency road numbers may be used where appropriate. USFS provided distinctive route marker(s) may be used.

- v. Advance destination signs will only be used where special emphasis is required. Examples are limited sight distance, high traffic volumes, multi-lane (more than two) highways, and high speed areas.
  - vi. Agencies are encouraged to work together to develop specific signing to multiple destinations.
3. **Signs Furnished by USFS.** The USFS is financially responsible for and will furnish, install, and maintain the following sign categories:
- a. Signs with pedestal bases such as large boundary or administrative site signs (examples shown in Figure 217).
  - b. The following signs are included in this category: National forest boundary (FE or FL); recreation site (RS); headquarters (A or AS); and special interpretive signs. These signs are normally located outside the highway right of way/easement or at parking areas. A permit from ODOT is required for placement within the highway rights of way/easement. All signs within the highway right of way/easement shall be installed on breakaway sign supports, or protected by barrier, or shall be removed by USFS when requested by ODOT.
  - c. USFS will furnish, install, and maintain all temporary warning, regulatory, and guide signs; other traffic control devices (such as delineators, barricades, and temporary pavement markings); and all other appropriate devices which are needed to warn and control traffic during emergencies, construction, or maintenance activities, for which the USFS is responsible.
4. **ODOT and USFS Cooperative Signing.** ODOT and the USFS will cooperate in the installation and maintenance of the following categories of signs (examples shown in Figure 218). Sign requests will be made to the ODOT district manager at least 60 calendar days in advance by the USFS forest supervisor. A proposed sign plan will be provided by the USFS that shows the signs and their proposed locations. ODOT will review, modify, and approve or deny the request.
- a. Recreation Fee signs and logos will be furnished by the USFS. ODOT will maintain the signs and logos including installing new signs and logos on existing posts as appropriate to inform motorists when recreation fees will be charged. This maintenance will be provided at ODOT expense. Installations requiring new posts will be charged to the USFS. Logos on existing guide signs that direct motorists to national forest facilities where fees are required will be installed and maintained at ODOT expense.
  - b. National Forest Scenic Byway signs will be furnished by the USFS. ODOT will install and maintain the signs at ODOT expense. Installations requiring new posts will be charged to the USFS.



- c. USFS administrative and recreation signs within the state highway right-of-way/easement not covered in other categories will be furnished by the USFS. ODOT will install and maintain these signs. Installations requiring new posts will be charged to the USFS. The USFS and ODOT will agree in a separate project agreement as to how maintenance and other installation expenses will be shared.
5. **Highway Advisory Radio Signs.** USFS will coordinate with and abide by ODOT requirements to obtain a permit for highway advisory radio (HAR) signs. Requirements are listed in ODOT's "Guidelines for Highway Advisory Radios" and in the "Sign Policy and Guidelines for the State Highway System." These signs will provide the USFS the capability to communicate forest information to motorists using the vehicle's AM radio receiver. The forest service shield, "National Forest" logo, and "Northwest Forest Pass" logo may be incorporated into the HAR sign layout. USFS will reimburse ODOT for all costs involved in the fabrication, installation, and maintenance of the HAR signs. Any reimbursement(s) will be authorized by a separate appropriate document.
6. **Signs Off the Right of way/easement.** Signs installed off the right of way/easement, and visible to highway travelers, will comply with The Federal Highway Beautification Act of 1965, Part 750, Subpart B, National Standards for Official and Directional Signs (750.153 and 750.154); the Oregon Motorist Information Act; and ORS 377.505 to 377.545. Permits for such signage will be obtained from ODOT's Outdoor Advertising Program.
7. **USFS Shield.** The parties recognize the USFS "shield" and "National Forest" script logo are copyrighted by the Department of Agriculture and will be allowed and should be used as USFS identification as approved by the USFS. The USFS logo is not needed on a sign if specific words such as "national forest" are used.

Figure 216: Examples of signs where ODOT is responsible for installation and maintenance

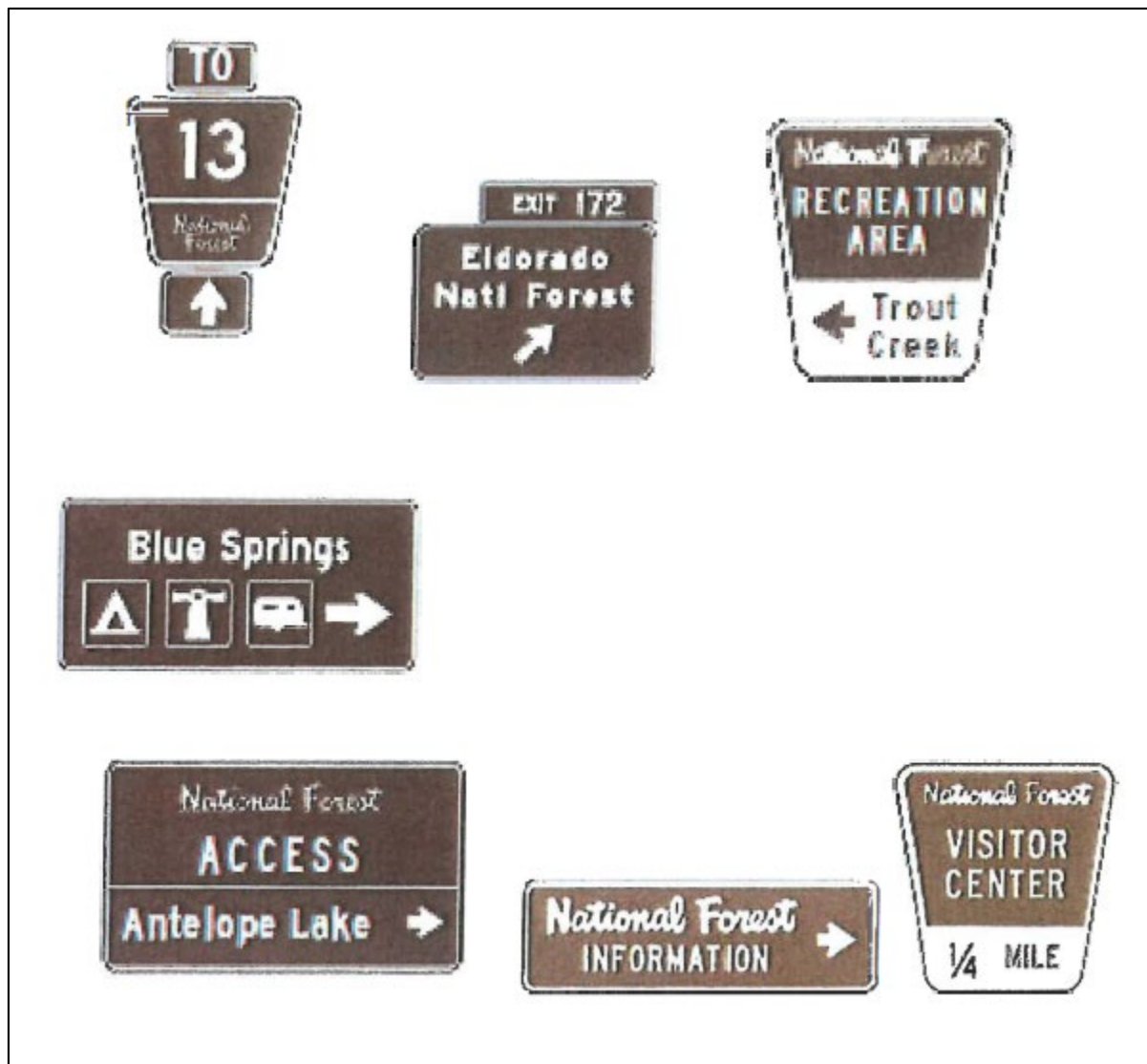

Figure 217: Examples of signs where USFS is responsible for installation and maintenance

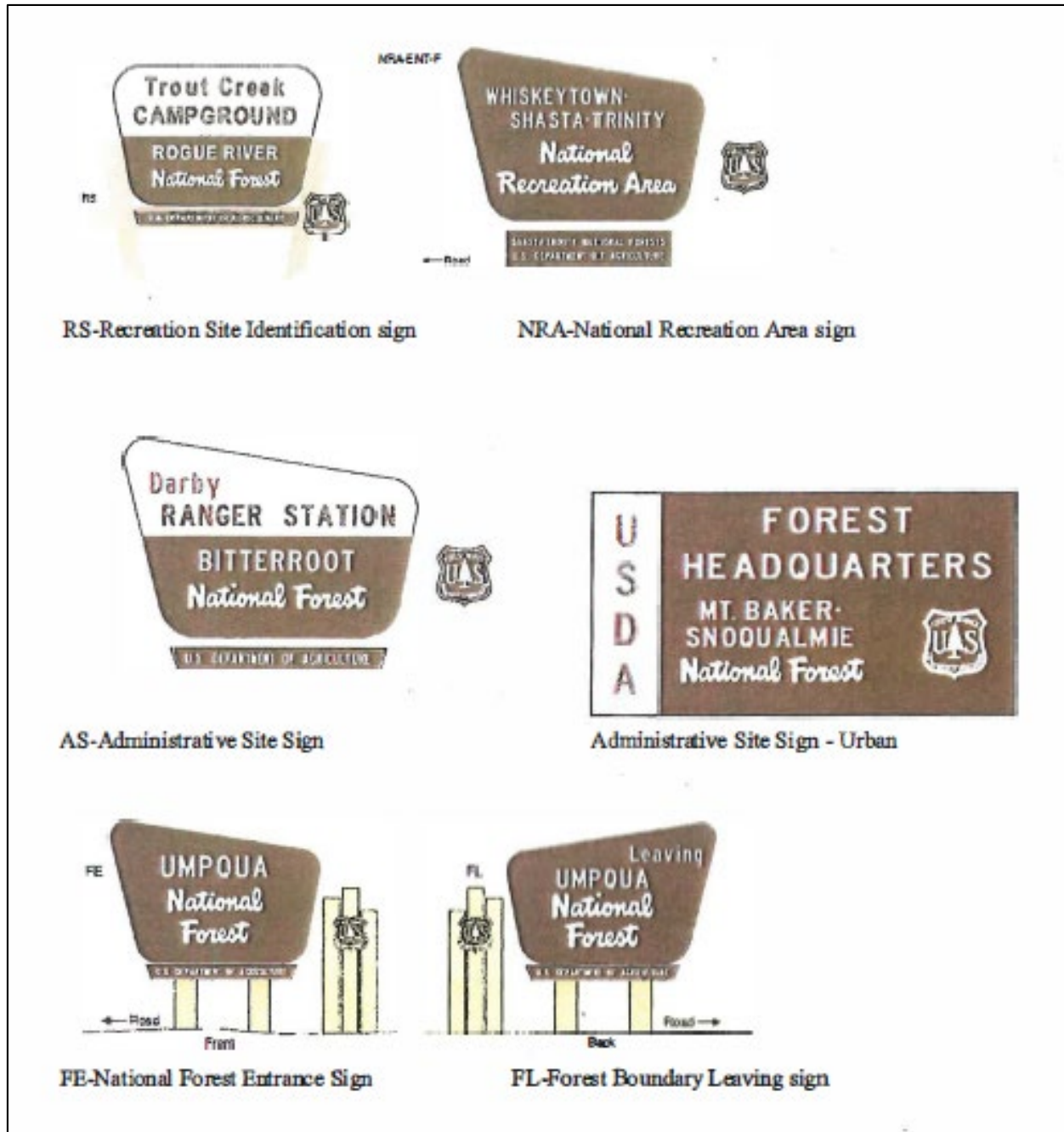

Figure 218: Examples of signs where USFS/ODOT share financial performance responsibility for installation and maintenance

National Forest Scenic Byway (Chapter 3A.13.1)



Note: Department of Transportation designated byways prevail in priority over Forest Service byway designations and should be signed according to the MUTCD, Section 2D.55.

Recreation Fee Sign Examples and Fee Logo



# Appendix B: Oregon Sign Detail Index

Table 200: Oregon Sign Detail Index

<b>Sign Legend or Purpose</b>	<b>Sign No.</b>	<b>Chapter</b>
ABRUPT EDGE	CW21-7	6
Abrupt Edge Riders	CW21-8A CW21-8B CW21-8C	6
ABRUPT EDGE roll-up sign	CW21-9	6
ADOPT-A HIGHWAY	OD417	5
ADOPT-A LANDSCAPE	OD418	5
ALL TRUCKS OVER 20,000 GVW NEXT RIGHT	OR22-4	3
APPLEGATE TRAIL	OI7-9	5
APPLEGATE TRAIL SITE	OI7-8	5
APPLEGATE TRAIL INFO. CTR.	OI7-11	5
APPLEGATE TRAIL INTERP. CTR.	OI7-10	5
BARLOW ROAD ROUTE	OI7-6	5
Bicycle EVENT AHEAD	CW15-15a	6
Bicycle Event Route	CG20-21	6
BICYCLE RACE AHEAD	OBW16-2	6
BICYCLE RACE IN PROGRESS	CW17-1	6
BICYCLE RIDE IN PROGRESS	CW17-2	6
Bicycle (Symbol) STOP	OBR1-1	8
Bicycle (Symbol) YIELD	OBR1-2	8
Bicycles CROSSING ROADWAY	CW11-1a	8
Bicycles KEEP LEFT	CR4-22a	8
Bicycles KEEP RIGHT	CR4-22b	8
Bicycles ON ROADWAY	CW11-1	8
Bike Directional Signs	OBD1-1c OBD1-2c OBD1-3c	8
Bike Lane Ends Symbol	OBW1-9	8
Bike - Ped Warning	OBW8-22	8
Bike Railroad Crossing Symbol	OBW8-19	8

Sign Legend or Purpose	Sign No.	Chapter
BIKES IN TUNNEL WHEN LIGHTS FLASH SPEED 30	OBW1-8	8
BRAKE CHECK AREA Signs	OW21-4 OW21-5 OW21-6	4
Bridge Weight Limit	OR12-6	3
BRIDGE WORK AHEAD	CW21-10	6
BUSINESS ACCESS	CG20-11	6
BYPASS PHOTO ENFORCED	OW16-10	4
CALIFORNIA TRAIL	OI6-1	5
CHAIN REMOVAL AREA Signs	OW22-4a OW22-5 OW22-6	4
CHAIN-UP AREA Signs	OW22-1a OW22-2 OW22-3	4
CONGESTION	OW15-6	4
CONSTRUCTION VEHICLE DO NOT FOLLOW	CW23-14	6
CROSSWALK CLOSED	OR22-7	3
DETOUR w / Vertical Arrow	CG20-6	6
DIVING OR JUMPING FROM BRIDGE PROHIBITED	OR21-2a	3
DO NOT DRIVE BESIDE TRUCKS	OR4-22	3
DO NOT PASS SNOWPLOWS ON THE RIGHT	OR22-9	3
DON'T LITTER MAX. FINE \$6250	OR21-3a	3
END DETOUR	CG20-5	6
END ROAD WORK	CG20-2A	6
END SAFETY CORRIDOR	OD-449	5
END SPEED ZONE	OR2-6a	3
ENTERING XX City	OD-411A	5
ENTERING XX County	OD-412	5
ENTERING WINTER RECREATION AREA PARKING PERMITS REQUIRED IN SNO-PARKS NOV 1 TO APRIL 30	OD11-1	5
ENTERING WINTER RECREATION PARKING PERMITS REQUIRED BEYOND THIS POINT NOV. 1 TO APRIL 30	OR18-1	3
EROSION CONCERNS	CG20-10	6
EVENT AHEAD	CW15-15	6

<b>Sign Legend or Purpose</b>	<b>Sign No.</b>	<b>Chapter</b>
EXCEPT BUS	OR3-7a	3
Flagger Ahead Symbol	CW23-2	6
Flagger NEXT MILE	CW20-7b	6
FORM 2 LANES WHEN METERED	OR20-5	3
GEOLOGICAL MARKER AHEAD	D-424a	5
HELMETS REQUIRED	OR22-2	3
Heritage Site	ORG-010	5
HIGH WATER	OW15-12	4
Highway Advisory Radio Sign	OW22-7	4
HISTORICAL MARKER AHEAD	D-424	5
Horizontal Clearance Sign	CW21-12	6
Hydrant Marker	OD450	5
INTERMITTENT ROAD WORK NEXT XX MILES	CG20-13	6
Lane Restriction Signs	OR5-11	3
Left and Right Arrow	OR3-5TD	3
LEFT LANE, BUS & LEFT TURN ONLY	OR3-11c	3
LEFT LANE, BUS ONLY	OR3-11b	3
LEFT TURN LANE CLOSED	CW23-13	6
LEFT TURN LANE CLOSED AHEAD	CW23-12	6
Left Turn ONLY	OR3-5L	3
LEFT TURN YIELD TO ONCOMING TRAFFIC	OR17-1	3
LEFT TWO LANES CLOSED AHEAD	CW20-5a	6
LENGTH LIMIT	OR12-8	3
LEWIS AND CLARK TRAIL	OI5-1	5
LONG LOAD	OW15-17 OW15-17a	4
LOOSE GRAVEL XX MPH	CW8-7a	6
Low Clearance Sign	OW12-2P	4
MAX WIDTH (Horizontal Clearance)	CW21-12	6
MOBILE DEVICE USE PROHIBITED WHILE DRIVING	OR21-4a	3
Motor Carrier Pilot Car STOP Marker	OR14-6	3
MOTORCYCLISTS STATE LAW REQUIRES USE OF LIGHTS AT ALL TIMES	OR22-1	3
NO FISHING FROM BRIDGE	OR21-1	3

Sign Legend or Purpose	Sign No.	Chapter
NO LANE CHANGES AHEAD	OW22-15	4
NO LANE CHANGES NEXT XXXX FT	OR22-16	3
NO LANE CHANGES NEXT X/X MILE	OR22-17	3
NO OVERNIGHT PARKING	OR7-1	3
No Parking in Access Aisle	OR7-9	3
No Parking in Access Aisle supplemental Arrow	OR7-9a	3
NO PARKING FOR UNATTENDED VEHICLES	OR8-4a	3
NO PARKING FOR UNATTENDED VEHICLES NOV. 1 TO APR. 30	OR18-2	3
NO PARKING VEHICLES OVER X FT. HIGH	OR7-20	3
NON-MOTORIZED VEHICLES USE NEXT EXIT	OR5-3a	3
ON ROADWAY	OW11-1a	4
ONE VEHICLE PER GREEN	OR20-1	3
ONE WAY TRAFFIC FOR TRUCKS AND BUSES	OR5-11	3
OPEN RANGE	OW11-7	4
OREGON COAST BIKE ROUTE	OBD11-3	8
OREGON HISTORIC ROUTE	D-485	5
Oregon Scenic Byway	D-480 to 483	5
OREGON THANKS YOU COME BACK SOON	D461	5
Oregon Tour Route	D-484	5
Oregon Trail Signs	OI7-1 to OI7-6	5
OVERSIZE LOAD	OW15-16	4
PASSING LANE CLOSED AHEAD	CW23-6	6
Pedestrian EVENT AHEAD	CW15-15b	6
Pedestrian Event Route	CG20-20	6
Pedestrians CROSSING ROADWAY	CW11-2a	6
Pedestrians ON ROADWAY	CW11-2	6
POPULATION	OD-413a	5
PREPARE TO STOP WHEN LIGHTS FLASH	OW15-14	4
PRIVATE DR	OW14-3	4
Project Identification Sign	CG20-8	6
PULL OUT	OD12-1	4
PULL OUT X MILE	OD12-2	4



Sign Legend or Purpose	Sign No.	Chapter
PUSH BUTTON FOR PEDESTRIANS (SYMBOL)	OR10-3L OR10-3R OR10-4bL OR10-4bR	3
PUSH BUTTON FOR Peds HOLD FOR 2 SECOND FOR EXTRA CROSSING TIME	OR10-32L OR10-32R	3
PUSH BUTTON TO TURN ON WARNING LIGHTS	OR10-25L OR10-25R	3
RAMP CLOSED	OR22-18	3
Right Turn ONLY	OR3-5R	3
RIVER ROUTE	OI7-4	5
ROAD CLOSED TO THRU TRAFFIC LOCAL ACCESS ONLY	OR11-4a	3
ROAD WORK NEXT XX MILES	CG20-1	6
ROAD WORK XX MPH	CW20-1a	6
SAFETY BELTS (symbol) IT'S THE LAW	OR22-3	3
SAFETY CORRIDOR NEXT XX MILES	D447	5
SCENIC BIKEWAY Route	OBM1-8 OBM1-8a	8
Scenic Byway Signs	D-481 to D-483	5
SCHOOL BUS TURN AROUND	OS3-2	7
SCHOOL DAYS with Time of Day rider	OS4-8	7
SCHOOL IN SESSION	OS4-9	7
SCHOOL SPEED LIMIT 20	OS5-5	7
SIDEWALK CLOSED, Daily	CW11-5	6
SIDEWALK CLOSED, Full Time	CW11-4	6
SIDEWALK OPEN	CW11-3	6
SIDEWALK USERS WALK BIKES	OBR10-13	8
SIGNAL WORK AHEAD	CW21-11	6
SLIDES	OW15-19	4
SLOW	OW15-1	4
SLOW (For Bikes)	OBW15-1	8
SLOW TRUCKS	OW7-4	4
SNO PARK AHEAD 1/4 MILE	OD11-2	5
SNO-PARK PARKING PERMITS REQUIRE NOV 1 TO APRIL 30	OR18-3	3

Sign Legend or Purpose	Sign No.	Chapter
SNO-PARK PARKING PERMITS REQUIRE NOV 1 TO APRIL 30	OR18-4	3
Snow Lane Control	OR3-10a OR3-10b	3
SNOW ZONE	OW15-15	4
Snow Zone Riders	OR15-15	3
Speed Reduction	OW3-5	4
STATE LAW MOVE OVER OR SLOW DOWN	OR4-20a	3
STATE LAW TRUCKS-CAMPERS-TRAILERS-BUSES UNLAWFUL TO USE LEFT LANE(S) EXCEPT WHEN PASSING ON 4(6) LANE HIGHWAYS	OR4-18 OR4-19	3
STATE LAW UNMUFFLED ENGINE BRAKING PROHIBITED	OR22-10	3
STOP AHEAD	OW21-1	4
STOP Roll-up Sign	CR1-1	6
Through, Left & Right Arrow	OR3-5TT	3
TOUR ROUTE	OI7-4a	4
Tour Route, State Entrance	D-484	4
TRAIL SITE	OI7-3	4
TRAVEL ADVISORY TUNE RADIO 1XXX AM WHEN LIGHTS FLASH	OW22-7	4
TRUCKS-CAMPERS-TRAILERS-BUSES UNLAWFUL TO USE LEFT LANE(S) EXCEPT WHEN PASSING	OR4-16 OR4-17	3
TRUCKS ENTERING HIGHWAY XXXX FT.	CW23-7	4
TRUCKS LEAVING HIGHWAY XXXX FT.	CW23-8	4
TRUCKS RIGHT TWO LANES ONLY	OR4-5	3
TRUCK WEIGHING AHEAD With ON SHOULDER plaque	OW7-5	4
Tsunami Signs	OD-462 to OD-466	5
TUNNEL	OW15-11	4
TURNING VEHICLES stop FOR bikes & peds	OR10-15a	3
TURNING VEHICLES stop FOR peds	OR10-15	3
TURNING VEHICLES yield TO bikes	OR10-15b	3
UNLAWFUL TO THROW AWAY BURNING MATERIAL	OR16-6	3
UNMUFFLED ENGINE BRAKING PROHIBITED	OR22-11	3
U-TURN PERMITTED	OR3-12	3
WAIT FOR ASSISTANCE	CR4-24	6

<b>Sign Legend or Purpose</b>	<b>Sign No.</b>	<b>Chapter</b>
WAIT FOR FLAGGER	CR4-23	6
WAIT FOR PILOT CAR	CR4-20 CR4-20a	6
WEIGHT LIMIT REDUCED	OR12-5	3
WEIGHT LIMIT REDUCED FOR LEGAL LOADS	OR12-5f	3
WEIGHT LIMIT REDUCED FOR SINGLE UNIT VEHICLES ONLY	OR12-5g	3
Weight Limits	OR12-5d OR12-5e	3
WELCOME CENTER	OD9-10a	5
WELCOME TO XX City	OD-413	5
WELCOME TO XX County	OD-414	5
WELCOME TO OREGON	OD460	5
WHEELCHAIR USER ONLY	OR7-8c	3
WIDE LOAD	OW15-18	4
WRECK AHEAD	CW15-10	5
XX TON BRIDGE WEIGHT LIMIT XX MILES AHEAD	OR12-6	3
XXXX TRAIL Bike Sign	OBD11-3a	8
YIELD (For Bikes)	OBR1-2	8
YIELD CENTER LANE TO OPPOSING TRAFFIC	OR4-11a	3
YIELD CENTER LANE TO UPHILL TRAFFIC	OR4-11	3
YIELD TO ONCOMING TRAFFIC	OR22-6	3
24-HOUR FLAGGING AHEAD	CW20-9	6



ODOT provides a safe and reliable multimodal transportation system that connects people and helps Oregon's communities and economy thrive.

[www.oregon.gov/ODOT](http://www.oregon.gov/ODOT)

