



Pavement Marking Design Guidelines

Delivery & Operations Division | Traffic-Roadway Section
January 2022

ODOT is an Equal Employment Opportunity and Affirmative Action Employer.

This information can be made available in alternative format by contacting 503-986-3568

ODOT does not discriminate on the basis of disability in admission or access to our programs, services, activities, hiring and employment practices. Questions: 1-877-336-6368 (EEO-ODOT) or through Oregon Relay Service at 7-1-1.

Oregon Department of Transportation
Engineering & Technical Services Branch
Traffic-Roadway
4040 Fairview Industrial Drive SE
Salem, Oregon 97302
503-986-3568
Traffic Engineering Website

Table of Contents

Preface 1

Chapter 1: General Information 2

1.1 Responsibility for Pavement Marking Plans 2

1.2 When Pavement Marking Plans are Required 2

1.3 Useful Information for Plan Development 3

1.4 Coordination with Other Disciplines 4

Chapter 2: Survey Needs 7

2.1 General 7

2.2 Limits of Survey 7

Chapter 3: Plans, Specifications & Estimate Process 8

3.1 Scoping/Pre-DAP/Proof of Concept 8

3.2 Design Acceptance Plans 8

3.3 Preliminary Plans 9

3.4 Advanced Plans 9

3.5 Final Plans Review 10

3.6 PS&E Package 10

3.7 State Force Work 10

Chapter 4: Standard Drawings & Details 11

4.1 Standard Drawings 11

4.2 Standard Details 12

Chapter 5: Material Selection 13

5.1 General 13

5.2 Longitudinal Marking Materials 16

5.3 Transverse Marking Materials 17

5.4 Material Type Based on Project Type 18

5.5 Non-Standard Material and Applications 18

Chapter 6: Specifications & Special Provisions 20

6.1 General 20

6.2 Preparing the Special Provisions 21

Chapter 7: Estimate 23

7.1 General..... 23

7.2 Engineer’s Cost Estimate..... 23

Chapter 8: Post Bid Letting..... 24

8.1 Addenda..... 24

8.2 Construction Support 25

8.3 As-Constructed Plans 28

Chapter 9: Drafting Standards – General 29

9.1 Creating Pavement Marking Design Files..... 29

9.2 File Naming Convention..... 33

9.3 ODOT Pavement Marking Drafting Tool..... 35

9.4 Base File Augmentation 36

9.5 Reference Files 37

9.6 Borders and Title Block 37

9.7 Sheet Size and Scale 40

9.8 V-Number 40

9.9 Order of Pavement Marking Plans..... 40

Chapter 10: Drafting Standards – Plan Sheet Specific..... 41

10.1 Pavement Marking Details 41

10.2 Pavement Marking Plan..... 42

10.3 Striping Removal Plan..... 52

10.4 Pavement Marking Design Shown on Other Discipline’s Plan Sheets..... 53

10.5 Temporary Striping Plan Sheets 53

Appendix A – References 55

Appendix B – Designer Checklist..... 56

Appendix C – Example Project Title and Index Sheets 58

Appendix D – Example As-Constructed Plans..... 60

Appendix E – Examples of Pavement Marking Plans..... 63

This page has been intentionally left blank.

Preface

The purpose of this manual is to:

- Provide information and guidance to the designer regarding the pavement marking (striping, rumble strips, and delineators) contract plan development process.
- Provide drafting standards for pavement marking (striping, rumble strips, and delineators) plans.
- Ensure statewide consistency in contract plan development.

For information on pavement marking design standards and policies, the designer should refer to the current version of:

- The ODOT Traffic Line Manual.
- The Manual on Uniform Traffic Control Devices (MUTCD).
- The Oregon Supplement to the MUTCD.
- Oregon Standard Drawings and Standard Details.
- The ODOT Traffic Manual.
- Technical directives, bulletins and advisories.

These guidelines contain references to documents that will be periodically changed or updated, such as the ODOT Traffic Line Manual, standard drawings, and boilerplate special provisions. See Appendix A for web links to all of the resources.

Design standards and guidance may also be updated via a technical directive, technical bulletin, or a technical advisory prior to updating manuals.

Updating this manual is a continuing process and revisions are issued as required. Questions or suggestions for modifications should be addressed to:

Traffic Markings & Sign Engineer
4040 Fairview Ind. Dr. SE MS #5
Salem, OR 97302
503-986-3610

This manual is a web-only document, which can be accessed and printed in its entirety from the ODOT Traffic Engineering Section publications [website](#).

Chapter 1: General Information

1.1 Responsibility for Pavement Marking Plans

The responsibility for the preparation of pavement marking plans on state highways rests with either the traffic designer or roadway designer assigned. If possible, traffic designers should prepare pavement marking plans.

The region traffic engineer/manager shall review and approve all pavement marking plans regardless of who designs and/or stamps the plans. The region traffic engineer/manager may delegate this responsibility to a member or members of their staff competent in pavement marking design. The title block on the pavement marking plan sheets shall list either the region traffic engineer/manager's name or the delegated staff member's name in the "Reviewed By" location. See Section 9.6 for more information on the title block. The review process should take place during different phases of the project (e.g., design acceptance phase, preliminary, advanced, final, etc.).

Certain pavement marking design elements require state traffic engineer or region traffic engineer approval. The region Traffic Section is responsible for obtaining any such approval. See the ODOT Traffic Line Manual and the ODOT Traffic Manual for detailed information regarding delegated authority and design elements requiring approval.

1.2 When Pavement Marking Plans are Required

Sealed pavement marking plans are required for any project or maintenance activity where the existing pavement marking configuration will be modified. This includes maintenance, 1R, 3R and new construction projects.

Sealed pavement marking plans are strongly encouraged for any project or maintenance activity where the existing pavement markings will be replaced in-kind, which typically includes preservation and chip seal projects. Pavement marking plans for replace in-kind projects are particularly helpful and well worth the time to produce for complex urban locations, interchanges, and signalized intersections. Pavement marking plans are encouraged for the following reasons:

- **Creation of a pavement markings plan will ensure that project conforms to current standards:** Existing pavement markings on a project may not conform to current standards. While not all pavement marking standards can be updated on a preservation job (e.g., those standards that are directly related to roadway improvements such as increasing storage lengths, increasing shoulder widths, or tapers), many pavement marking standards can, and should, be updated. For example correcting lengths of no-passing markings, adding lane use arrows as required, changing line type, etc.

- **Creation of a pavement marking plan will aid field personnel during construction:** The contractor is required per the specifications to provide documentation of the existing pavement markings prior to starting replace in-kind work. However, this documentation is often done quickly and may lack necessary details, resulting in increased chance for installation errors. Pavement marking plans makes field layout easier and quicker for both the contractor and the inspector.
- **Creation of a pavement marking plan will lessen the chance for installation errors:** It is important for the pavement marking installation to be correct on the first application. Removal of mistakes is expensive and unforgiving (especially when using durable materials). If a mistake is made, removal of markings from the new pavement surface is often the only answer. Not only does this look ugly, but it creates “ghost lines” (the location of the ground-out pavement marking which remains visible to the motorist, especially in rainy conditions). It is less likely that an error will be made in the field if a pavement marking plan is produced ahead of time. There also is the benefit of allowing others the opportunity to review and provide comment.
- **Creation of a pavement marking plan will aid the designer in developing the bid item list and enable a more accurate cost estimate:** Accurate bid item lists and cost estimates are crucial to the construction office administering the project. Inaccurate bid items and cost estimates can lead to confusion, wasted time, and an increased construction cost.
- **Creation of a pavement marking plan documents the decisions of the engineer of record:** Documentation is always valuable, should issues arise in the future.

If the designer chooses not to produce pavement marking plans for replace-in-kind work, Section 00850.40 of the Oregon Standard Specifications for Construction instructs the contractor how to document and replace the existing pavement marking. The designer will still need to prepare the special provisions, bid item list and cost estimate for the project.

1.3 Useful Information for Plan Development

Before starting, the items listed below will help guide a designer in the initial stages of the pavement marking design.

- Review and become familiar with the current ODOT Traffic Line Manual.
 - Other documents such as the Oregon Standard Drawings, Oregon Standard Details, Manual on Uniform Traffic Control Devices (MUTCD), Oregon Supplement to the MUTCD, and the ODOT Traffic Manual will be helpful for source information, but the Traffic Line Manual should always be referenced for pavement marking design information.
- Review the [Technical Directives, Bulletins, and Advisories](#) website before each project to ensure that the most current design guidance is used.
- A copy of signed approval letter(s) from the state traffic engineer or region traffic engineer for any pavement marking design elements that require approval.

- Refer to the ODOT Traffic Line Manual and the ODOT Traffic Manual for detailed information regarding delegated authority and design elements requiring approval.
- Railroad pavement markings are typically specified in the railroad crossing order.
 - A copy of the railroad crossing order for any design criteria that will impact pavement marking design can be obtained from the rail crossing safety manager at 503-986-4273.

Designers determine which features pavement marking plans include. Consider the following:

- How are the roadway plans laid out? Pavement marking plans shall have the same alignment orientation, display and cut sheet layout as the roadway plans.
- Are there any recent changes in the pavement marking practices/policies that may affect the design?
 - Crosswalk orientation aligning with new Americans with Disabilities Act (ADA) ramps.
 - Rumble strip widths verified by region traffic engineer.
 - Transverse marking use and fish hook arrows at roundabouts.
- Are there any unique details not covered in the standard drawings?
 - Rumble strips.
 - Unique legends.
- Will the project include removal of existing pavement markings?
 - Changing passing zone lengths due to speed changes.
 - Adjusting markings for matching existing.
 - Adjusting markings to new standards.
- Is there a need to modify existing pavement markings outside of the project limits?
- Will required survey data be available for the proposed installation?
 - If not can LIDAR data or Google Earth aerial imagery be used to draw in existing linework?
- What pavement marking material(s) will be used in the project?
 - Check the region striping plan.
 - Check with the district striping maintenance manager.

1.4 Coordination with Other Disciplines

Designing the pavement markings requires coordination with other disciplines throughout the design process.

Pavement marking design is unique from most other technical disciplines in that two separate disciplines typically produce pavement marking plans:

- A roadway designer producing pavement marking plans needs to coordinate with the signing and signals designers.

- A traffic designer producing pavement marking plans needs to coordinate with the roadway, signing and signals designers.

Roadway

Coordination with the roadway designer is critical. The development of pavement marking plans normally occurs after the roadway design has been established. The roadway design is the foundation for placement of traffic control devices. The traffic designer should be involved early in the process to provide input into the roadway design. Certain pavement marking situations should be considered and laid-out in the early stages of the roadway design process (when cross-section changes can be easily made) to ensure that the traffic operation functions as intended and traffic control devices can be installed properly. These situations include, but are not limited to:

- Lane reduction transitions (merging situations).
- Lane addition transitions.
- Intersections (crosswalk placement, stop bar placement, turn lane development, truck turning radii, etc.).
- Entrance and exit ramps.
- Mid-block crosswalks.
- Raised median or channelizing islands.
- No-passing sight distance.
- Left/right turn lane storage length.
- Bicycle lanes and transitions.

Traffic

Pavement markings provide important traffic control information to motorists, bicyclists, and pedestrians, and have a direct effect on traffic operations, so coordination with the region's Traffic Section, the active transportation liaison, and the regional transit and rail coordinator is critical. For certain pavement marking situations, as mentioned above, the roadway designer should coordinate with the region's Traffic Section early in the design process (when cross-section changes can be easily made) to ensure that the roadway design is appropriate for the intended traffic operation.

In addition, there are certain pavement marking design elements that require an engineering study and approval from the region traffic engineer or state traffic engineer. These approvals should be started (verbally or at meetings) prior to the final design acceptance phase (DAP) milestone and obtained prior to the finished preliminary milestone. The region's Traffic Section is responsible for obtaining all necessary traffic approvals on a project. See Traffic Line Manual "Required Approvals" sections.

Signing

In many cases, pavement markings are used as primary traffic control devices to convey regulations and the signing may supplement pavement markings. For example:

- A “DO NOT PASS” sign is supplemental to a no-passing pavement marking line.
- A “Two-Way Left Turn Only” sign is supplemental to a two-way left turn lane pavement marking line.

In some cases, pavement markings are used to supplement other traffic control devices, such as signs. For example:

- A stop bar is supplemental to a “STOP” sign.
- A “SCHOOL X-ING” marking is supplemental to an advance school warning assembly sign.
- A yield line is supplemental to a “YIELD” sign.

There are also cases where both signing and pavement markings must be used together to convey traffic regulations to motorists. For example:

- Lane reduction transitions.
- Lane drop(s).
- On street parking.
- Railroad crossings.
- Midblock crosswalks.
- Advance stop bars in advance of mid-block crosswalks.
- Preferential lanes.

Coordinate pavement marking design with sign design depending on which traffic control device is the primary device.

Signals

Pavement marking design at signalized intersections is important, ensuring the signal will function as intended. Certain elements, such as detection, vehicle signal indications and pedestrian signal indications require coordinated placement with the pavement markings. Critical elements at a signalized intersection include:

- Crosswalk or stop bar placement.
- Lane use.
- Storage lengths of turn lanes.

The signal designer generally designs the equipment to fit within the pavement marking design. Make sure to inform the signal designer if significant changes are made to the pavement marking design just prior to submittal.

Chapter 2: Survey Needs

2.1 General

Survey information needed for pavement marking designs varies depending on the scope of the projects. However, the following information is typically needed for pavement marking design:

- Edge of asphalt pavement.
- Edge of concrete pavement.
- Edge of concrete at bridge decks.
- Face of curb (for sidewalks, raised channelizing islands, etc.).
- Face of guardrail.
- Location of ADA ramps.
- Location of signs.
- Location of signal heads.
- Existing pavement marking (lane lines, edge lines, extension lines, centerline, crosswalks, stop bars, legends, etc.).
- Location of concrete barriers, cable barriers, bridge rails, etc.

2.2 Limits of Survey

- The survey should extend at least 200-300 feet outside of established project limits to enable a good tie-in to existing pavement marking.
- Certain projects require centerline/lane line information 1,600 feet or more outside of established project limits to ensure that no-passing zones or lane line markings are appropriately installed, such as:
 - Addition of left turn lane channelization or a median.
 - Addition of right turn lane channelization.
 - Conversion of a drop lane to a non-drop lane or vice versa.
 - Modification of horizontal or vertical alignment.
 - Roadway realignment.

Chapter 3: Plans, Specifications & Estimate Process

3.1 Scoping/Pre-DAP/Proof of Concept

Evaluate the goals for each project. Consider the following either during scoping or prior to the DAP phase:

- Pedestrian features – crosswalks (where and what kind).
- Bicycle facilities – based on volumes, speeds, safety and space available/needed.
- Crash reduction features – investigate crashes and possible enhancements for prevention.
- Railroad crossings – required features from crossing order.
- Political implications – road diets, roundabouts, freight, etc.
- Upgrades to current design standards.

It is also important to coordinate with the roadway designer prior to DAP to make sure roadway footprints are completely set at DAP. It is critical that transitions, non-traversable medians, etc. provide enough width for striping transitions and striping maintenance equipment. Some roadway designers may not be aware of the design elements that a striping designer would know. Early, detailed communication regarding projects with complicated changes or design features needs to occur between the roadway and traffic designers.

3.2 Design Acceptance Plans

Pavement marking plans will probably not be included at DAP, since the roadway design is generally not complete until just before submission and review. However, the pavement marking design should be in progress, with emphasis on completing design for common situations that could potentially change the roadway design footprint:

- Lane reduction transitions (merging situations).
- Intersections (crosswalk placement, stop bar placement, turn lane development, truck turning radii, etc.).
- Entrance and exit ramps.
- Mid-block crosswalks.
- Raised median or channelizing islands.
- No-passing sight distance prior to medians or turn lanes.
- Left/right turn lane storage lengths.
- Bicycle lanes.

Choose pavement markings based on the region pavement marking strategy. Check with the striping maintenance manager and region traffic engineer/manager to ensure the pavement markings specified in plans and estimate are the kind they want to maintain and will last given applicable highway conditions, such as traffic volumes, weather and so on.

The pavement marking designer should be able to produce an accurate estimate for the DAP phase using designs from both complicates and typical areas. The cost estimate should be submitted to roadway for the DAP phase.

3.3 Preliminary Plans

Pavement marking plans need to be included in the preliminary plans distribution. Providing a preliminary pavement marking plan helps ensure the roadway design will allow for proper traffic operations and placement of traffic control devices while there is still ample time to modify the roadway design.

Ensure a thorough review of the preliminary pavement marking plans is completed both prior to submittal and during the general review process by the following:

- Region traffic safety.
- Region traffic engineer/manager.
- Striping maintenance manager.
- Active transportation liaison.
- Peer review with someone familiar with pavement marking plans.

Preliminary pavement marking plans are typically 75-90 percent complete at preliminary plans distribution. In order to get advance plans to 100 percent complete, it is critical to solicit feedback and resolve identified issues provided by interested stakeholders (e.g., the region Traffic Section, Maintenance, bicyclists, pedestrians, Freight Mobility, Roadway Section, and other designers).

3.4 Advanced Plans

Advance plans are typically 100 percent complete at advance plan distribution. Pavement marking layout should not change unless certain signing changes are required. At this time, the pavement marking designer should review the roadway plans, signing plans, and signal plans against the pavement marking plan for consistencies.

The advance plans distribution date is provided by the project leader. The drawings need to be ready for the assigned specifications writer, with special provisions and engineer's cost estimate several weeks earlier than the schedule dates. Typically that includes:

- Pavement marking plan sheets.
- Pavement marking special provisions.
- Engineer's cost estimate.

Download and complete all applicable [boilerplate special provisions](#) for every project, even if there are no special bid items. Follow the instructions within the word document and delete unneeded text with track changes turned on.

Project special provisions for specialty items need to be written and approved by both the technical expert from the Traffic-Roadway Section (Technical Leadership Center) and the specifications group in the Project Controls Office. The technical expert should approve the

special provision prior to submitting for advance plans. The specifications group will not give approval until just prior to the PS&E submittal.

The specifications writer will compile the plan sheets, special provisions and the engineer's cost estimates from all project disciplines for distribution. If Traffic-Roadway Section (TLC) staff needs to review the pavement parking plans, notify the specifications writer and provide them with contact information.

3.5 Final Plans Review

Final plans are printed digitally after the comments from the advance plans and plans-in-hand meeting are addressed, and the roadway V-number is added to the plan sheets. At this time, the Project Controls Office, the specifications writer and other designers perform a final review.

A review checklist for drafting and design of pavement markings is shown in Appendix B.

3.6 PS&E Package

After all changes have been made, the status stamp is removed from the seals in the individual plan sheets and the engineer of record digitally signs the individual plan sheets in ProjectWise.

The engineer of record also needs to print to PDF their professional of record (POR) page from the completed specifications book and digitally sign with their digital signature.

3.7 State Force Work

State force projects are small, quick fix type projects normally developed by the region Traffic Section in response to safety or maintenance concerns. These projects are generally carried out by state forces who do the work or who have contracts in place for others to do the work without an advertised bid project process. For example, left or right turn lanes may be retrofitted, lane use at intersections may be modified, or traffic movements may be prohibited at a particular intersection. Any change to existing pavement markings should be approved by the region traffic engineer (and the state traffic-roadway engineer if applicable) prior to application.

When pavement marking modification is necessary, other traffic control devices may also need to be modified accordingly. Region Traffic Section staff should be consulted to ensure that all traffic related aspects are considered and appropriate.

Many times survey data and base maps do not exist for state force projects. Using aerial imagery from [Google Earth Tool](#) may be helpful. In these cases, drafting the approximate dimensions and a note on the drawing stating it is not based on survey and dimensions need to be field verified should be included.

Chapter 4: Standard Drawings & Details

4.1 Standard Drawings

[Oregon Standard Drawings](#) are referenced by the contract plans via the pavement marking plans and are not included as a hard copy in the bid package. Once the contract is awarded, the contract plans include hard copies of the referenced standard drawings.

For a plan set, the pages following the title sheet are index sheets, which show a list of plan sheets including pavement marking plan sheets and the standard drawings that are referenced by the designer. The standard drawings may be identified with a full list with titles or a simplified list accompanied by box. When the designer finishes the pavement marking plan sheets for a milestone submittal, coordinate with the roadway designer/drafter on the number of pavement marking plan sheets and the standard drawing list so they may update the index sheets. The pavement marking designer should always check the index sheets to make sure it correctly lists the pavement marking plan sheets and referenced standard drawings. Appendix C shows examples of title sheet and index sheets.

Standard drawings are maintained by the ODOT Traffic-Roadway Section and are updated twice a year, once in January and once in July. An effective date is shown on each standard drawing, which applies to the bid let date. At each revision update, every standard drawing will get a new effective date, regardless of any content changes. If any content changes are made, they will be listed and dated in the standard drawing title block. The designer needs to make sure that the appropriate standard drawings relevant to project bid let date are used and should be aware of the status of the content changes. The effective dates for each revision update are shown below:

- January update – effective date from June 1 to November 30.
- July update – effective date from December 1 to May 31 of the following year.

Standard drawings are sealed by ODOT engineers of record and cannot be modified by the designer. The designer is responsible for selecting the appropriate standard drawings, applicable to their project, and list them on the pavement marking plans. Each standard drawing has a corresponding standard drawing report containing information about how the drawing was developed, including the history and assumptions made. Standard drawing reports can be helpful to the designers in selecting applicable standard drawings.

Appendix A contains a web link to the standard drawings and standard drawing reports. The standard drawing TM500 series are used in the design of pavement markings plans, which also contains drawings used for delineator installation.

4.2 Standard Details

[Oregon Standard Details](#) typically contain installation information that is either used infrequently, used on non-state highway roadways, and/or must be modified based on the project-specific situations.

Designers use standard details to create project-specific pavement marking detail plan sheets. They are included in the contract plans set and sealed by the engineer of record. The designer can and should modify standard details to fit unique, project-specific requirements. Often there are notes to the designer in the standard detail containing further information on the appropriate use and modification of the detail.

Standard details are maintained and updated by the Traffic-Roadway Section and can be updated at any time. Designers should always download a copy from the website to ensure the most up-to-date detail is used.

The standard details from DET4500 to DET4599 are used in design of pavement marking plans. This series also contains drawings used for rumble strip installation.

Chapter 5: Material Selection

5.1 General

The decision to select a certain material and application method for a project rests with the region striping maintenance manager, with concurrence from the region traffic engineer.

The region striping maintenance manager is responsible for creating and maintaining a pavement marking material management plan for the entire region. This plan is available upon request and should be used as a guide when scoping and designing projects.

Materials and application methods should be selected such that they meet or exceed the performance requirements at the lowest cost. To maximize cost-effectiveness, material selection should be based on:

- Roadway surface type.
- Traffic volume.
- Expected remaining service life of the pavement.
- Future expected projects.
- Pavement markings of the adjacent sections.
- Available funding and ability to maintain.

Also, there may be a need to use markings with audible and tactile characteristics based on crash history or markings with wet weather performance depending on geographical location. Since the region striping maintenance manager and traffic engineer have different levels of knowledge related to the various material selection considerations, both perspectives should be involved in selecting the material and application for a project.

Materials need to be selected separately for longitudinal and for transverse markings. In some cases, multiple materials and/or application methods for longitudinal and/or transverse markings on the same project may be specified in order to meet the chosen performance requirements within the project budget. For example, a non-profiled line (Method B) may be adequate for lane line markings, but a more expensive profiled line (Method A) may be desired for the edge line or centerline to address lane departure crashes.

Project scheduling will directly affect the quality of permanent striping. Most permanent materials require an ambient air temperature of at least 50°F and dry pavement. Hot-laid materials like thermoplastic are especially sensitive to moisture. Even if the surface is dry, the heat of the material can draw moisture from deeper in the pavement and affect the marking's bond to the pavement.

In most areas, permanent materials should be installed before September 15 to meet these temperature and moisture requirements. If permanent striping is not installed by this time, less durable temporary markings that can be installed at lower temperatures may need to be used to

winter-over the project. This may be difficult to achieve for paving projects, but projects without paving should use an end date that keeps an acceptable striping weather window.

Figure 5.1 shows different types of longitudinal and transverse pavement marking types available for use along with their performance features. Specification sections 00850 through 00868 contain installation information.

Figure 5-1: Available Pavement Marking Types and Their Performance Features

Material & Application Choices						Performance Feature Choices								
Specification Section	Specification Method	Material	Surface Application Type	Application Method	Line Characteristics	Basic Performance (Line Presence & Retro-reflectivity)	Short Life Span	Mid-Length Life Span	Long Life Span	Audible/Tactile	Wet Weather Retro-reflectivity	Protection from infrequent snow plowing	Protection from frequent snow plowing & increased durability under heavy traffic volumes	
00855	N/A	Raised Pavement Markers	Surface Mounted Recessed	N/A	N/A	X* X*	X			X	X			
00860	N/A	Paint	Surface Installed	Sprayed	Non-Profiled	X	X			X	X		X	
00865	Method A	Methyl Methacrylate (MMA)	Surface Installed	Extruded	Non-Profiled	X			X					
			Grooved Installed		Profiled	X		X	X		X	X		
			Surface Installed		Profiled	X		X	X					
		Thermoplastic	Surface Installed	Extruded	Non-Profiled	X		X						
			Grooved Installed		Profiled	X		X	X		X	X		
			Surface Installed		Profiled	X		X	X					
	Method B	Methyl Methacrylate (MMA)	Surface Installed	Sprayed	Non-Profiled	X			X					
			Grooved Installed		Profiled	X		X			X	X		
	Thermoplastic	Surface Installed	Sprayed	Non-Profiled	X		X							
		Grooved Installed		Profiled	X		X			X	X			
	Method C	Tape		Rolled-In Hot	N/A	Non-Profiled	X			X				
				Rolled-In Hot		Profiled	X		X			X		
				Rolled-In Hot		Wet Weather	X		X		X	X		
				Grooved Installed		Non-Profiled	X		X			X	X	
				Grooved Installed		Profiled	X		X			X	X	
				Grooved Installed		Wet Weather	X		X		X	X	X	
	Method D	Methyl Methacrylate (MMA)	Surface Installed	Extruded or Sprayed	Wet Weather	X			X					
			Grooved Installed		Wet Weather	X		X			X	X		
Surface Installed		Extruded	Profiled Wet Weather	X		X	X	X						
Thermoplastic			Surface Installed	Extruded or Sprayed	Wet Weather	X		X		X				
Grooved Installed	Wet Weather	X			X		X	X	X					
Surface Installed	Extruded	Profiled Wet Weather	X		X	X	X							
Method AB	Methyl Methacrylate (MMA)	Surface Installed	Extruded or Sprayed	Non-Profiled	X			X						
Thermoplastic	Surface Installed	Non-Profiled		X		X								
00866	Method 1	Plural Component	Surface Installed	Extruded	Non-Profiled	X		X						
					Wet Weather	X		X			X			
					Hi-Build Paint	Non-Profiled	X		X					
	Method 2	Plural Component	Surface Installed	Sprayed	Non-Profiled	X		X						
					Wet Weather	X		X			X			
					Hi-Build Paint	Non-Profiled	X		X					
	Method 1-2	Plural Component	Surface Installed	Extruded or Sprayed	Non-Profiled	X		X						
					Wet Weather	X		X			X			
					Hi-Build Paint	Non-Profiled	X		X					
00867	Type A	Thermoplastic	Surface Installed	Extruded or Sprayed	Non-Profiled	X		X						
	Type B	Thermoplastic	Surface Installed		Pre-formed	Non-Profiled	X		X					
	Type B-HS	Thermoplastic	Surface Installed	Extruded, Sprayed, or Pre-formed	Pre-formed	High Skid Resistance	X		X					
	Type AB	Thermoplastic	Surface Installed		Non-Profiled				X					
00868	Green	Thermoplastic	Surface Installed	Pre-formed	High Skid Resistance	X		X						
	Bicycle	Methyl Methacrylate (MMA)		Extruded	High Skid Resistance	X		X						

*Only to be used in conjunction with other marking materials (paint, MMA, thermoplastic, etc.)

The designer does NOT need to specify the following for a project (see the specifications and bid item section of this manual for more information):

- Reflective elements (as per the qualified products list – QPL listing or manufacturer’s recommendation via specification).
- Specific material formula (as per the QPL listing via specification).
- Pavement surface primers or pavement surface preparation (as per manufacturer’s recommendation via specification).
- Adhesives for raised pavement markers (RPMs) (contractor choice of epoxy or bituminous via specification).
- Application methods for certain materials (pre-defined via specification or standard drawing).
- Thickness of materials (pre-defined via specification or standard drawing).

5.2 Longitudinal Marking Materials

Materials for longitudinal markings can be divided into three general categories: non-durable, durable and other.

- **Non-durable marking material** is standard waterborne traffic paint. This is the least expensive marking material and has a relatively short service life. Installation information is contained in specification section 00860.
- **Durable marking materials** offer performance features above and beyond what a non-durable marking material can provide. These materials are more expensive to install but have a longer service life than non-durable marking material. Installation information of durable markings is contained in specification section 00865.
 - Thermoplastic.
 - Profiled or non-profiled.
 - Surface or groove installed.
 - Extrusion or spray.
 - Methyl Methacrylate (MMA).
 - Profiled or non-profiled.
 - Surface or groove installed.
 - Extrusion or spray.
 - Tape.
 - Hot-laid or groove installed.
 - May be patterned. Installation information of durable markings is contained in specification section 00865.
- **High Performance Markings**
 - Modified urethane epoxy (plural component).
 - Polyurea.
 - High-build paint.

- Offer a mid-range life cycle, somewhere between the performance of a non-durable and a durable marking material.
- **Raised Pavement Markers**
 - Type I – Reflective.
 - Raised or recessed.
 - Abrasion resistant (AR).
 - Used to supplement other marking materials or used as vehicle positioning guide.
 - Type II – Non-reflective.
 - Installation information is contained in specification sections 00855 and 00866 for pavement markers and high performance pavement markings, respectively.

5.3 Transverse Marking Materials

Materials for transverse markings are required to be a durable product. Installation information is contained in specification section 00867 and special provision 00868. There is only one material available for use, thermoplastic, with four different options:

- **Type A, thermoplastic, liquid hot-laid** – This method involves melting a tank of material and either spraying the material over a stencil form or extruding the material. This method is economical when there is a large quantity of legends to be installed as specialized equipment must be mobilized and a large amount of thermoplastic must be melted for use in the equipment.
- **Type B, thermoplastic, preformed** – This method involves hardened, preformed pieces of thermoplastic that are placed on the pavement and melted in-place by a torch. This method is economical when there is a small quantity of legends to be installed or the project is in a remote location.
- **Type B-HS, thermoplastic, preformed high-skid** – This method is the same as Type B, but incorporates crushed glass or aggregate on the surface creating a marking with greater skid resistant characteristics. This method is required (via the specifications and bid items) for certain markings that have a high probability of contact with bicycles or pedestrians, such as continental crosswalk markings and bike lane stencils.
- **Type AB, thermoplastic** – This method allows the contractor to choose either Type A, Type B or Type B-HS as defined above. This method should be used as the default material type on your project for all legends (with the exception of those markings that must be Type B-HS) unless the region striping manager requests a specific legend material type be used.
- **Green bicycle lane, preformed thermoplastic film** – This method is a green colored version of Type B-HS thermoplastic used exclusively in the bike lanes/transitions to give added emphasis to the presence of a bike lane in high conflict areas or at intersections.
- **Green bicycle lane, methyl methacrylate** – This method can be used instead of the thermoplastic film by mixing the methyl methacrylate chemicals with crushed glass or

aggregate and them spreading in an even thickness across the pavement area being marked.

- **Red transit lane, preformed thermoplastic film** – This method is a green colored version of Type B-HS thermoplastic used exclusively in the bike lanes/transitions to give added emphasis to the presence of a transit only lane.
- **Red transit lane, methyl methacrylate** – This method can be used instead of the thermoplastic film by mixing the methyl methacrylate chemicals with crushed glass or aggregate and them spreading in an even thickness across the pavement area being marked.

Two other material types have been used in the past by ODOT, but are no longer used:

- **Type C, tape** – ODOT discontinued this method in 2007 due to low usage and performance issues in prior years.
- **Type D, methyl methacrylate** – ODOT discontinued this method in 2009 due to low usage, environmental and health concerns and maintenance issues.

5.4 Material Type Based on Project Type

Different regions may develop their own policies for durable pavement marking as related to project development. Region policy should be followed, if it exists. Region Traffic engineer/manager and the region pavement markings manager should be contacted to find out if a region has a policy. If the region does not have a policy, use the guidelines below.

- **Modernization Projects** – Typically specify a durable longitudinal line whenever feasible. When this is not a viable option (based on funding), explore and plan for the following options.
 1. Use a non-durable line on the current project, and a separate (future) contract to install durable markings. Durable marking only contracts often include other areas that have non-durable markings in need of upgrade.
 2. The region pavement marking crew may be able to commit to applying durable markings during the next scheduled re-striping.
- **Preservation Projects** – Typically replace the existing material type in-kind, unless there is a reason to change. If replacing an existing durable material in-kind is not a viable option (based on funding), evaluate the two options detailed in the modernization projects subheading.

5.5 Non-Standard Material and Applications

Generally, the designer is responsible for specifying the standard marking materials and applications, per the current specifications and [qualified products list](#). However, there may be cases where a non-standard material or application method may be considered, such as a local agency requesting a colored or textured crosswalks (see the [ODOT Traffic Line Manual](#) for information on ODOT's policy.) There are also placeholders listed in the standard specification

bid item list (e.g., methyl methacrylate, protected inlaid, wet weather pattern, and extruded) that do not have corresponding specifications or standard drawings/details. In these cases, contact the Traffic-Roadway Section for assistance in developing plans and specifications.

Chapter 6: Specifications & Special Provisions

6.1 General

Typically, two separate documents are needed to complete the project specifications (both can be found on the [ODOT Standard Specifications web page](#)):

- The current version of the “Oregon Standard Specifications for Construction.”
- Boilerplate special provisions.

The “Oregon Standard Specifications for Construction” is a published book, also known as standard specifications, and remains static for five to ten years. On the other hand, special provisions add, modify, and/or delete portions of the standard specifications, based on project-specific needs. The special provisions are intended to supplement or supersede the information in the standard specifications.

If an item or type of work is shown in the plans, it must have the appropriate special provision included in the contract documents for that project. Some of the boilerplate special provisions do not actually contain any updated information but simply make reference to the standard specifications. These boilerplate special provisions must still be included in the contract documents. Always download the most recent copies of the boilerplate special provisions for each project and check prior to finalizing them for your project since modifications can occur at any time.

Background information on standard specifications, special provisions and guidance for writing construction contract specifications can be found at the [ODOT Standard Specifications web page](#).

The following is a list of specifications and special provisions that are related to pavement markings:

- 00840 – Delineators and Milepost Marker Posts
- 00850 – Common Provisions for Pavement Markings
- 00225 – Pavement Marking Removal
- 00855 – Pavement Markers
- 00856 – Surface Mounted Tubular Markers
- 00857 – Rumble Strips
- 00860 – Longitudinal Pavement Markings – Paint
- 00865 – Longitudinal Pavement Markings – Durable
- 00866 – Longitudinal Pavement Markings – High Performance
- 00867 – Transverse Pavement Markings – Legends and Bars
- 00868 – Colored Lane Markings
- 00869 – Curb and Non-Traversable Median Markings

6.2 Preparing the Special Provisions

Below is an outline of the step-by-step process required in the preparation of the special provisions:

- Determine which specifications are applicable to your project.
- Download the current [boilerplate special provision](#) of each applicable section.
- Edit each boilerplate special provision according to instructions within the boilerplate to meet your project needs.
 - Use Microsoft Word with “track changes” turned on.
 - If track changes is not used, review and future modifications become difficult.
 - Instructions to the designer are provided in orange, bold and italic font within parentheses (Figure 6.2-1).
 - Remove the instructions from the special provisions. It will appear in the balloon in the right margin.
 - Edit the boilerplate special provision as necessary depending on the project needs.
 - Any modification of boilerplate special provision, which is not mentioned in the instructions, **requires** the technical expert’s review and approval, as well as review and approval from the specifications team. Refer to Appendix A for the specification technical expert list.

Figure 6.2-1: Example Special Provisions Instructions

(Follow all instructions. If there are no instructions above a subsection, paragraph, sentence, or bullet, then include them in the project but make necessary modifications to only include project specific specifications. Delete specifications that do not apply to the project.)

The following example in Figure 6.2-2 is used on projects with inlaid markings according to the instructions in orange font.

Figure 6.2-2: Inlaid Markings Example Special Provisions Instructions

[Use this subsection .45 when "Grooved Installation" is included in the project. Delete the subsection number and title if Method B or Method C markings are also included in the project.]

00865.45 Installation - Replace the bullet that begins "Grooved Installation..." with the following bullet:

- **Grooved Installation** - Grind slot depth to 130 to 150 mils with a smooth, uniform flat bottom. Apply tape into slot.

If this subsection applies to your project, simply delete the instruction set. Your special provisions should look like Figure 6.2-3.

Figure 6.2-3: Example Deleted Special Provisions Instructions

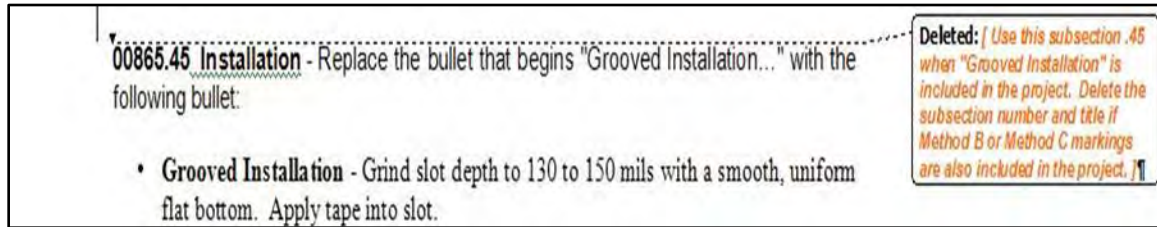

If this subsection does not apply to your project, delete the instruction set and the text that it applies to. Your special provision should look Figure 6.2-4.

Figure 6.2-4: Example Deleted Special Provision



For some projects, it may be required to write a project specific special provision, which can be defined as any modifications to the boilerplate special provisions or new stand-alone specifications. Project-specific provisions are required when current standard specifications and boilerplate special provisions don't meet project needs. For example, if you want to use contrast tape markings for a project, you need to prepare a project-specific special provision since current standard specifications and boilerplate special provisions don't cover contrast tape marking installation. Project-specific special provisions require concurrence from the specification technical expert. Figure 6.2-5 shows a project-specific special provision, created by modifying a boilerplate special provision.

Figure 6.2-5: Example Modified Special Provision

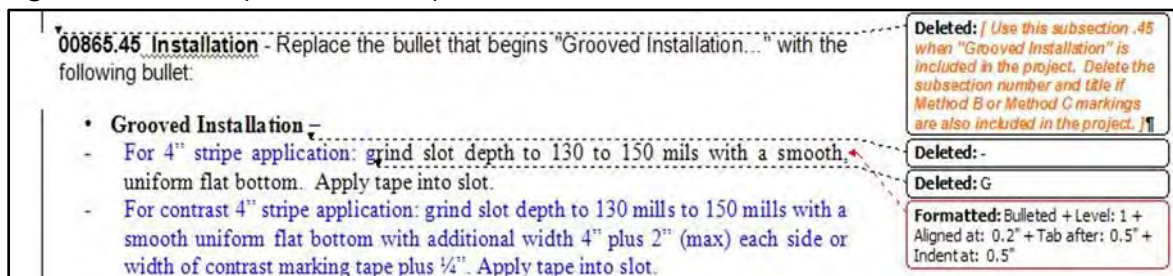

Always use the track changes feature while editing boilerplate special provisions to ensure all revisions to the original document are captured and visible.

The edited boilerplate special provision/project-specific special provision (with track changes) is submitted to the specification writer for review distribution. Typically boilerplate special provisions are submitted for the advance plan review.

Chapter 7: Estimate

7.1 General

Bid items are defined in the standard specifications and special provisions in each respective pavement marking specification section.

Generally, the designer uses the bid item list provided online (refer to Appendix A). The Traffic-Roadway Section specifications technical expert may change or modify bid items at any time, so it is always a good idea to obtain the most recent copy from the website for each project. If a unique bid item is required for a project, approval from the Traffic-Roadway Section specifications technical expert is required.

7.2 Engineer's Cost Estimate

Once the appropriate bid items are chosen, a cost estimate must be completed. The bid item costs are based on:

- Historical data.
- Available industry data.
- Manufacturer quotes and project specific research.

ODOT's average [bid item prices](#) can be obtained online.

Chapter 8: Post Bid Letting

8.1 Addenda

Changes to the plans, special provisions, or bid items during the advertisement period are made by addenda. The earlier an addenda is posted the more time contractors will have to properly address the changes. Issuing multiple addenda is preferred over one large last minute addenda. Last minute addenda can cause prospective bidders to withdraw from bidding and/or include unnecessary risk pricing. Large last minute addenda are also difficult to review quickly and often result in a postponement when contractors find errors that must be fixed.

All unsolicited issues, questions and inquiries from contractors and others will be directed to the construction project manager per Standard Specification Section 00120.15 and the ODOT Construction Manual, Chapter 6 (refer to Appendix A for website). All inquiries must go through the construction project manager; a single, non-conflicting answer from ODOT (that can be issued to all bidders) is required to ensure a fair bidding process.

Revised sealed and signed digital plans must be submitted with any addenda that modifies a plan sheet. Revision triangles are required on all revised plan sheets as shown in the Contract Plans Development Guide – no exceptions. An example plan sheet with revision notes is shown in Figure 8.1.

For more information on the addenda process, contact the quality engineer and see Section 4.3 of the [Phase Gate Delivery Manual](#).

Figure 8.1: An Example Plan Sheet with Revision Notes

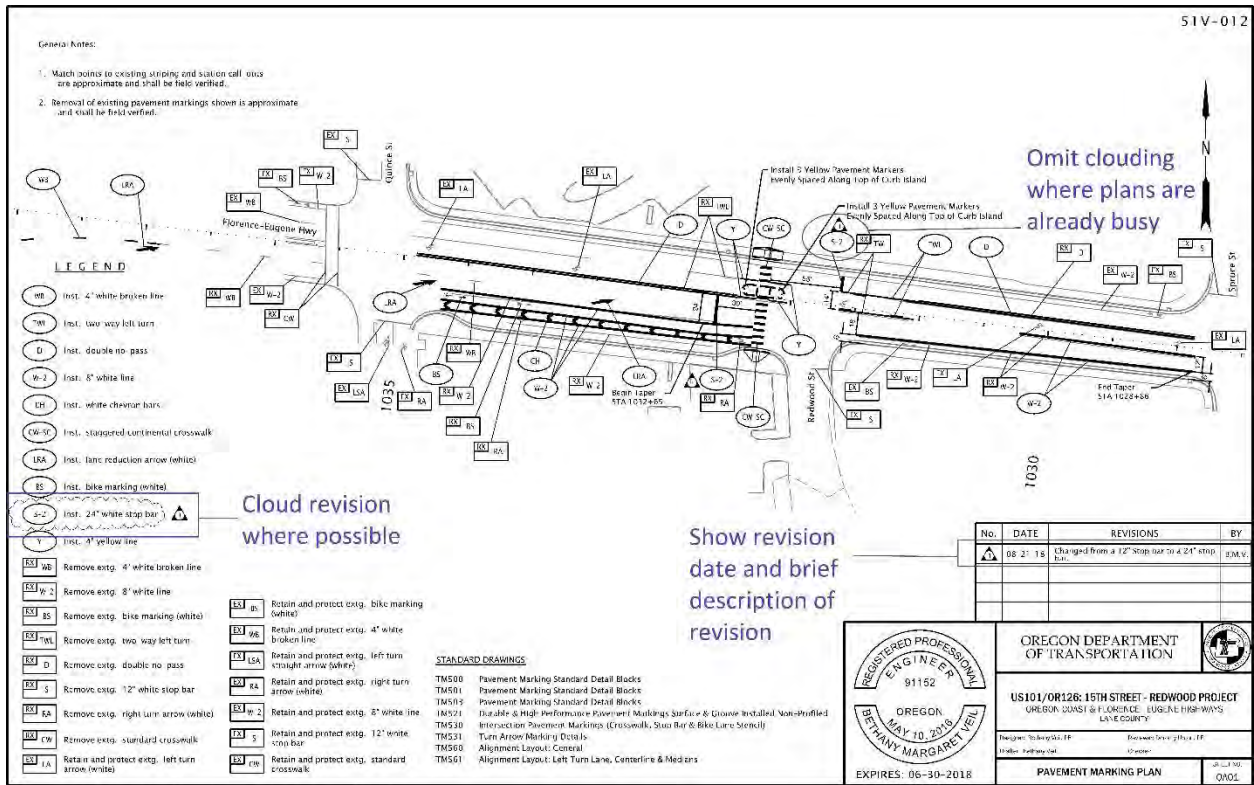
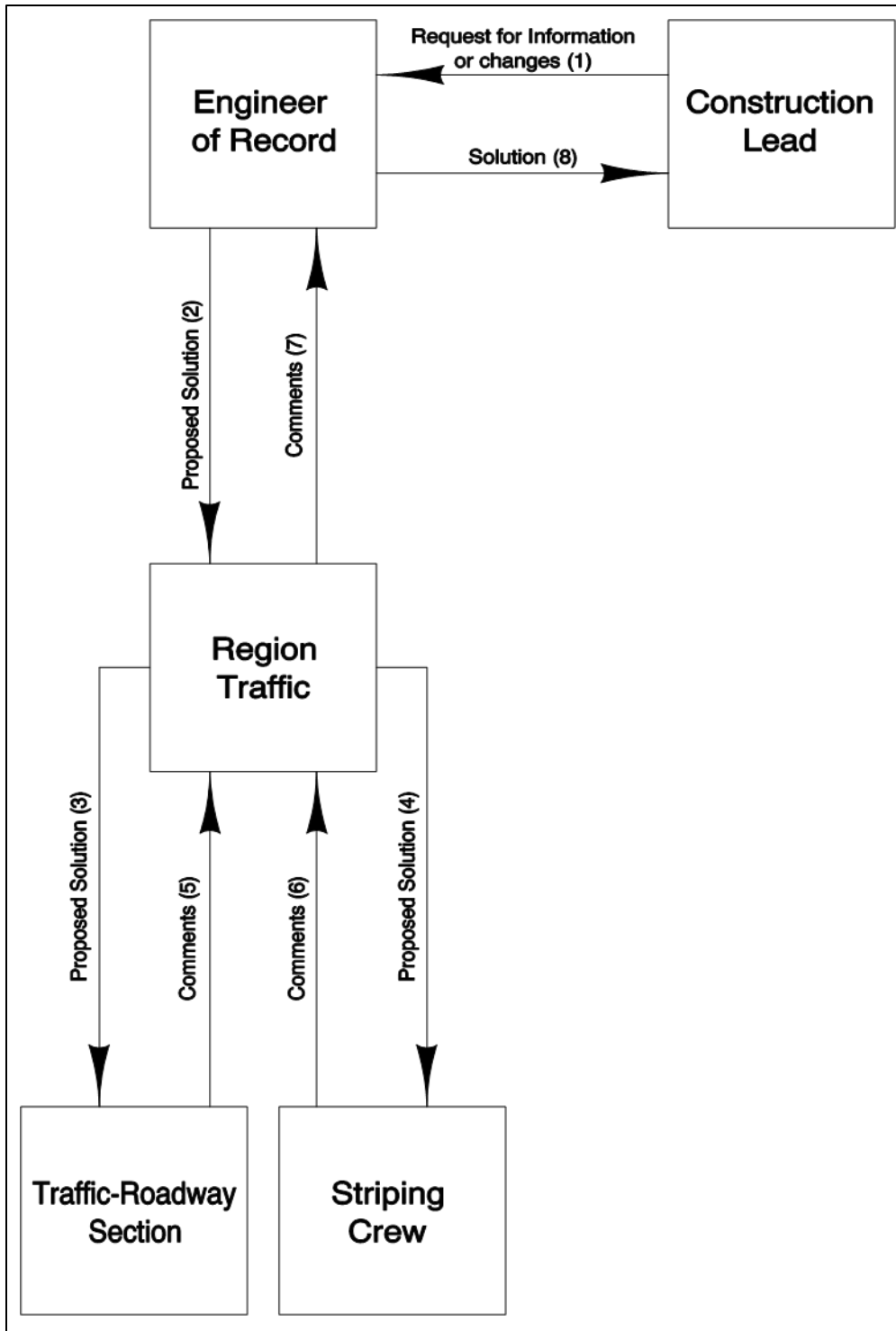

Figure 8.2: Flow Chart for Request for Information/Change



Boxes from Figure 8.2:

- Construction lead – This is the ODOT designated construction lead. This could be a project manager, consultant project manager (CPM), project leader, district permits, local agency liaison, etc.
- Engineer of record (EOR) – This is the person or firm that produced the pavement marking plans. This could be ODOT, local agencies, consultants, etc. If the EOR is unreachable, consult with the Traffic-Roadway Section for guidance.
- Region Traffic – This is the ODOT region-based traffic office.
- Traffic-Roadway Section – This is the ODOT Traffic-Roadway Section. The state traffic engineer (STRE) leads this section.
- Striping crew – These are the ODOT pavement marking crew managers for the specific region.

Arrows from Figure 8.2

- Request for information or changes (1) – This action includes the construction lead submitting contractor questions, contractor proposals, errors in the plans and/or specifications, etc. to the EOR for review and comment. For clarification of plans and/or specifications, skip to STEP 8. For proposed changes to the plans and/or specifications, continue to STEP 2.
- Proposed solution (2) – This action includes the EOR submitting plans, specifications, estimates, requests to deviate from standards, etc. to region traffic for review, comment, and/or approval. For minor changes, skip to STEP 7. For major changes, continue to STEP 3.
- Proposed solution (3) – This action includes the region traffic submitting plans, specifications, estimates, requests to deviate from standards, etc. to the Traffic-Roadway Section for review, comment, and/or approval.
- Proposed solution (4) – This action includes the region traffic submitting plans, specifications, estimates, requests to deviate from standards, etc. to the pavement marking crew for review, comment, and/or approval.
- Comments (5) – This action includes the Traffic-Roadway Section approving, requesting re-submittal, or rejecting the proposed solution to the region Traffic Section.
- Comments (6) – This action includes the pavement marking crew approving, requesting re-submittal, or rejecting the proposed solution to the region Traffic Section.
- Comments (7) – This action includes the region Traffic Section approving, requesting re-submittal, or rejecting the proposed solution to the EOR based on the Traffic-Roadway Section and the pavement marking crew comments (for major changes). If the solution is rejected, start over at STEP 2.
- Solution (8) – This action includes the EOR submitting an approved solution to the construction lead. The solution may include revised plan sheets, revised specifications, and/or new plan sheets. The construction lead will then direct the contractor based on the approved solution.

8.3 As-Constructed Plans

The purpose of producing as-constructed contract plans is to accurately reflect the actual project as it was constructed in the field. As-constructed plans can be a useful reference for future work in the same area. For this reason, accuracy and clarity are important in the production of as-constructed plans.

Producing as-constructed plans is necessary, because contract plans often change during construction for various reasons.

The region construction office is responsible for marking-up contract plans to show how the pavement markings were installed. Each plan sheet shall have a stamp “AS CONSTRUCTED” along with signature of the project manager and date.

Example as-constructed plans are shown in Appendix D.

Units of measure will be maintained for all as-constructed plans.

Projects plans produced by consultants, developers or local agencies shall produce a complete set of pavement marking plans, labeled and verified as as-constructed. Submit the as-constructed plans to the region tech center.

Refer to Technical Bulletin [TSB08-01\(B\)](#), Chapter 12-H of the [Construction Manual](#), and the [Contract Plans Development Guide](#) for additional information related to the as-constructed process.

ODOT designers:

Archive all CADD files used to create contract plan sheets after the project is let. Follow the ProjectWise process for archiving CAD files.

Consultant designers:

Submit all CADD files used to create contract plan sheets to the region traffic office on CD/DVD for archival after the project is let, if the project was not in ProjectWise. Otherwise follow the ProjectWise process for archiving CAD files.

Chapter 9: Drafting Standards – General

9.1 Creating Pavement Marking Design Files

Create at least two MicroStation files to produce contract plan sheets for pavement markings:

- **The pavement marking design file (base file):** This file will contain the actual pavement markings that will be installed or removed in the field, along with relevant elements of the roadway design base map, such as centerline, edge of pavement, median, curb line and so on.
- **The pavement marking plan sheet file:** This file will contain the individual plan sheets, bubble notes, legends and general notes. The pavement marking design file will be referenced into the pavement marking plan sheet file.

Use additional files as needed or outlined in the [Contract Plans Manual](#) and the [ProjectWise User Manual](#) and as necessary for your project needs.

Create a Pavement Marking Design File (Base File)

Create a new file in MicroStation by right clicking in ProjectWise and selecting “New” then “Document.” You may also open an existing file and create a new file from a 2D seed file. Name the file according to the ProjectWise Document Name List and the [Contract Plans Manual](#) using the ProjectWise file naming wizard. See section 9.2 for more information on file names associated to pavement markings.

After referencing the survey and roadway base files, draw the pavement marking design features into the file. Reference the signing and signal base files, as they become available, to coordinate design of the overall project. Attach the base file to the plan sheet files, as a reference file, to create contract plan sheets. Other designers will also use this file to attach to their plan sheets (signing and signals).

Some designers begin their design using a working file, stored within their discipline folders. This is true for pavement markings, as for other disciplines. The working files from related disciplines may be available for reference prior to their conversion into base files, allowing for greater coordination among the various discipline designers prior to DAP. Make sure to reference the base file for plans and design for all project milestone submissions. Ensure the base file includes all the design features in the working file.

Create a Pavement Marking Plan Sheet File

Create a new 2D file that will be your pavement marking plan sheet file. Name the file as shown in the ProjectWise Document Name List and the [Contract Plans Manual](#) using the ProjectWise file naming wizard. See section 9.2 for more information on file names associated to pavement markings. This file will contain all of the non-pavement marking features, such as the notes and

bubbles, borders, title block, and any other text needed for the contract plan sheets, as shown in Figure 9.1-3. Figure 9.1-4 shows a plan sheet file with design file attached.

There are multiple ways to cut plan sheets either manually or using InRoads. Generally, as long as there are roadway plan sheets, the easiest way to create the pavement marking plan sheets is to reference the roadway sheet file into your new plan sheet file and select copy all attachments in the nested references settings. From there, exchange references, as needed, for different base files needed in the pavement marking plan sheet files.

Create Other Pavement Marking Files for Ease of Plans Development

You may create other files to ease plan development. For example, a CAD file containing references with all the levels turned on and off, the way they will appear in the plan sheet, and then with nested references not allowing overrides, to keep consistency in the plans.

You may also use a working file to develop various options or changes before copying and adjusting pavement marking design in the base file.

Figure 9.1-1: Base Map Example

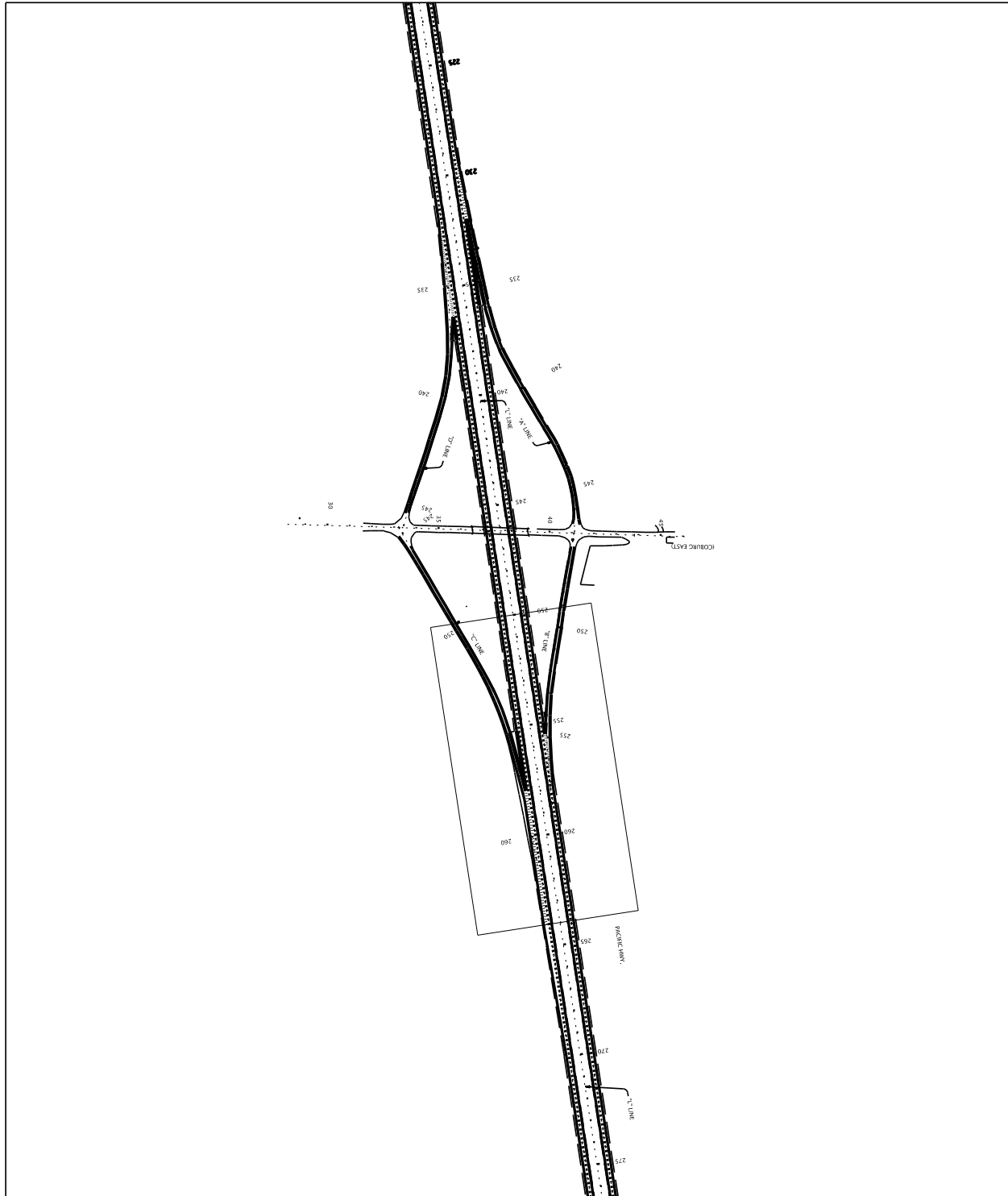

Figure 9.1-2: Base Map Example (Zoomed from Figure 9.1-1)

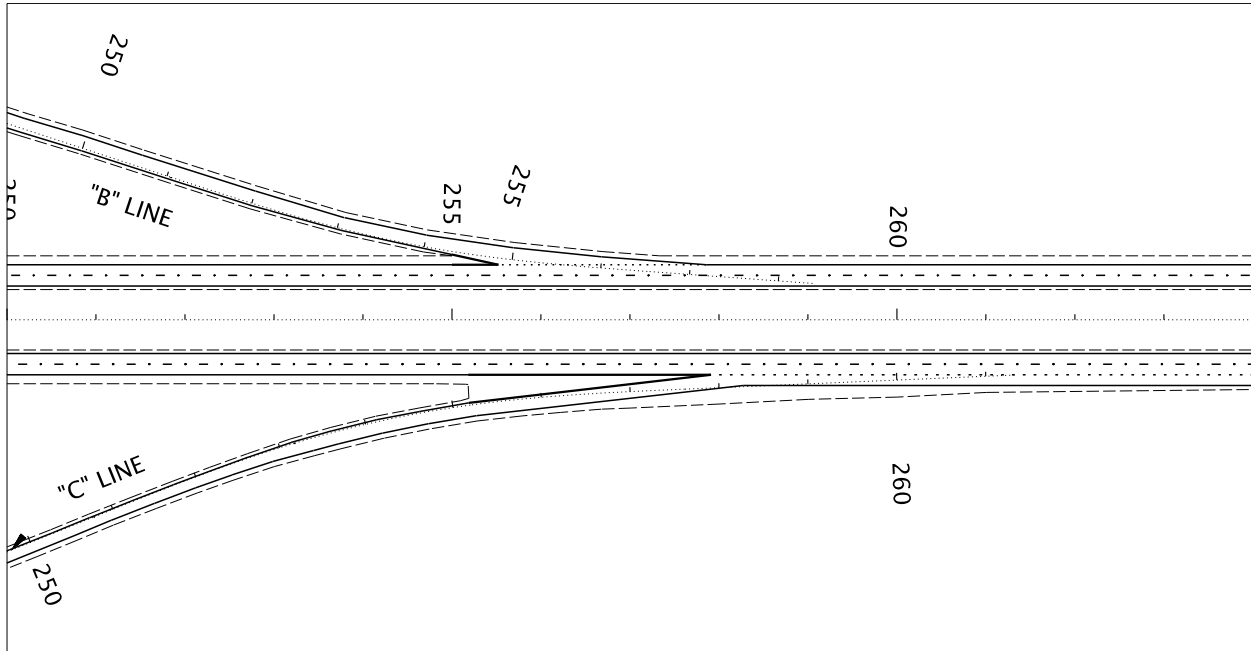

Figure 9.1-3: Pavement Marking Plan Sheet File Example without Design File Referenced

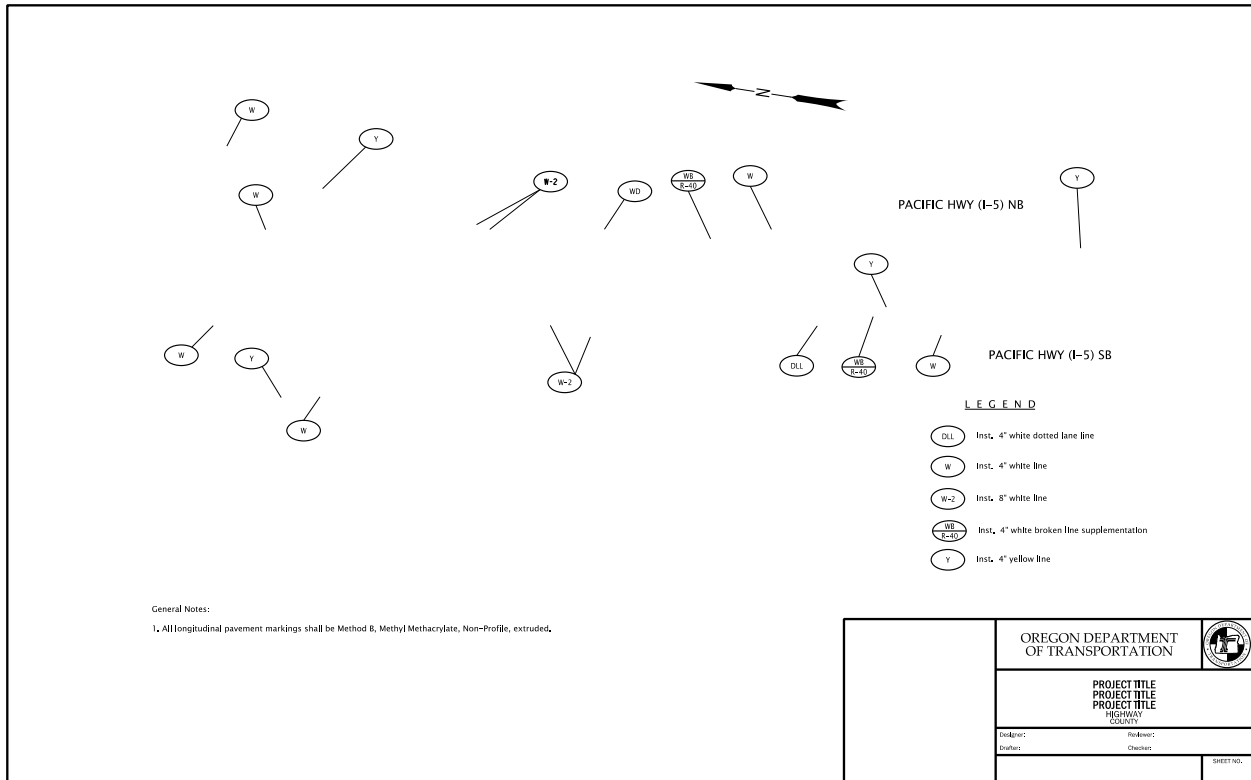
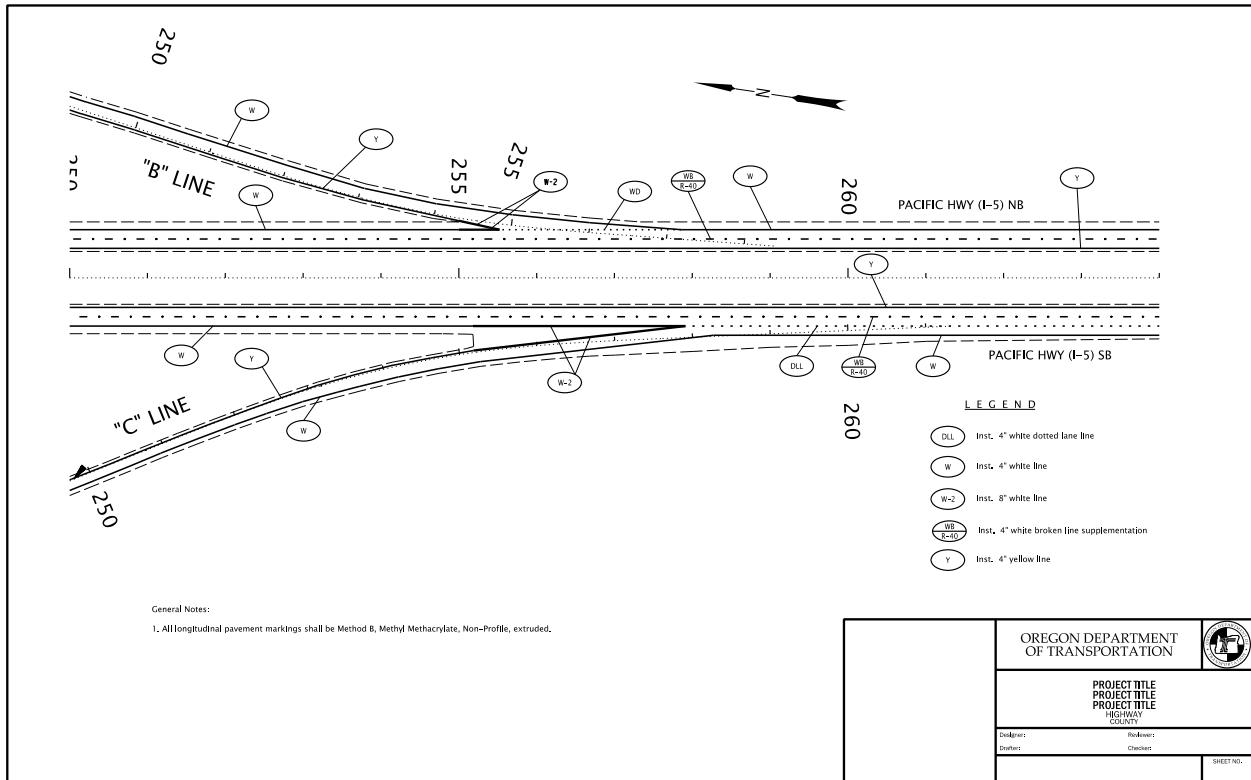

Figure 9.1-3 is an example of a pavement marking plan sheet file without the design file referenced. It contains bubble notes, title block, border and general notes.

Figure 9.1-4: Pavement Marking Plan Sheet File Example with Design File Referenced



9.2 File Naming Convention

Follow current ProjectWise standards for naming files. Make sure to use and follow the naming wizard when creating new files in ProjectWise.

The current file names associated with pavement marking and a brief description of what the files are used for are listed below:

- TM_K#####_photo_Y####M##D##_##_ - Name for a photo associated with pavement markings that can be differentiated in the file description by <Location>.
- TM_K#####_stdt_##_ - Name for a details plan sheet file that can be differentiated in the file description by <Sheet-No> and <Scale>.
- TM_K#####_stpr_##_ - Name for a removal plan sheet file that can be differentiated in the file description by <Sheet-No> and <Scale>.
- TM_K#####_stpl_##_ - Name for a striping plan sheet file that can be differentiated in the file description by <Sheet-No> and <Scale>.
- TM_K#####_PSET_##_ - Name for a pavement marking print set file.
- TM_K#####_LnkDoc_cad_##_ - Name for notes or a table that is linked to a DGN.

- TM_K#####_st_cad_## - Name for a pavement Markings CAD base file for plan sheets.
- TM_K#####_pmd_bas_## - Name for a pavement marking design base file that can be differentiated in the file description by <Name>.
- TM_K#####_std_wrk_## - Name for a working pavement markings file that can be differentiated in the file description by <Name>.
- TM_K#####_SLEDTM_##- Name for a Digital Terrain Model file that is used for sight line evaluations.
- TM_K#####_SLEITL_## - Name for an InRoads Template Library file that is used for sight line evaluations.
- TM_K#####_SLEIRD_## - Name for an InRoads Roadway Designer file that is used for sight line evaluations.
- TM_K#####_ALG_XXX_## - Name for a working geometry alignment that can be differentiated in the file description by <Location>.
- TM_K#####_ALG_XXX_HRpt_## - Name for a horizontal alignment report file that can be differentiated in the file description by <Alignment>. A working file can be stored in the pavement markings folder and a final horizontal alignment report would go into the 7_3D_Design folder.
- TM_K#####_ALG_XXX_VRpt_## - Name for a vertical alignment report file that can be differentiated in the file description by <Alignment>.
- TM_K#####_Calc_## - Name for pavement marking calculation files that can be differentiated by a <Title> in the description of the file.
- TM_K#####_dDAPEst_## - Name for the estimate file associated with the dDAP phase.
- TM_K#####_DAPEst_##- Name for the estimate file associated with the DAP phase.
- TM_K#####_PrelimEst_##- Name for the estimate file associated with the Preliminary phase.
- TM_K#####_AdvEst_##- Name for the estimate file associated with the Advance phase.
- TM_K#####_FinEst_##- Name for the estimate file associated with the Final phase.
- TM_K#####_PSnEEst_##- Name for the estimate file associated with the PSnE phase.
- TM_K#####_fDAPEst_##- Name for the estimate file associated with the fDAP phase.
- TM_K#####_PIEst_##- Name for the estimate file associated with Project Initiation.
- TM_K#####_Est_##- Name for the estimate file that can be differentiated by a <Title> in the description of the file.
- TM_K#####_Est_wrk_## - Name for the working estimate file.
- TM_K#####_RRPlan_## - Name for a set of plans that has been redlined and can be differentiated by a <Title> in the description of the file.
- TM_K#####_PrePlan_## -Name of the pavement marking plan sheets (PDF) for the Preliminary phase.
- TM_K#####_fDAPPlan_## -Name of the pavement marking plan sheets (PDF) for the fDAP phase.
- TM_K#####_dDAPPlan_## -Name of the pavement marking plan sheets (PDF) for the dDAP phase.

- TM_K#####_DAPPlan_## -Name of the pavement marking plan sheets (PDF) for the DAP phase.
- TM_K#####_PIPlan_##-Name of the pavement marking plan sheets (PDF) for Project Initiation.
- TM_K#####_AdvPlan_## -Name of the pavement marking plan sheets (PDF) for the Advance phase.
- TM_K#####_FinPlan_## -Name of the pavement marking plan sheets (PDF) for the Final phase.
- TM_K#####_Plan_## - Name of the pavement marking plan sheets (PDF) that can be differentiated by a <Title> in the description of the file.
- TM_K#####_Q_## - Name for a quantity file that can be differentiated by a <Title> in the description of the file.
- TM_K#####_Misc_## - Name for a miscellaneous file that can be differentiated by a <Title> in the description of the file.

There may be additional names in the pavement marking naming options that are not typically associate with pavement marking files. These are rarely used and may be typically associated to another discipline.

9.3 ODOT Pavement Marking Drafting Tool

ODOT developed a drafting tool to aid in drafting and designing MicroStation files using agency standards. A separate menu is available for the preparation of pavement marking plans containing different longitudinal line types, along with reflectors and transverse markings (both bars and legends). The tool also places bubble notes, legends and leaders, making the development of the pavement marking plans more efficient. The drafting tool also places all accessed items in the correct level, using correct color, weight and line style.

The striping ribbon can be accessed from ODOT Traffic Striping menu. Within the striping ribbon, there are five striping tool options:

- **Long Lines:** Contains different longitudinal line types used for pavement marking design. It also contains a line style for longitudinal rumble strips.
- **Reflectors and Buttons:** Contains cells for raised pavement markers with appropriate spacing used for substitution and supplementation of pavement markings and for vehicle positioning guide, as well. When these cells are used, it is not required to draw separate lines with which reflectors are used.
- **Pavement Bars:** Contains the cells for standard and wide stop bars. Use these to draw standard crosswalks.
- **Pavement Legends:** Contains cells for various transverse pavement marking legends, such as arrows, bike markings, railroad markings etc.
- **Striping Notes:** Used to detail pavement marking plans, such as placing bubbles with leaders and texts. Figure 9.3 shows the Place Note Striping toolbox.
 - Choose your note type, followed by category, and note.

- Check the box next to “Draw Leader Line” if you want to draw a leader line.
- Check the box next to “Include Legend Text” if you want to draw the legend text.
- If you want a callout note above and/or below the bubble, enter it in the “Top Callout” or “Bottom Callout” text fields, or choose a standard callout note from the popup menus. The note is shown under your cursor, as when placing a cell (the note actually is a cell created on the fly by the tool). Data point to place the note.
- If “Draw Leader Line” is checked, data point again to place the leader. Reset to exit the tool.

Figure 9.3: Place Note Striping Tool (CONNECT Version)

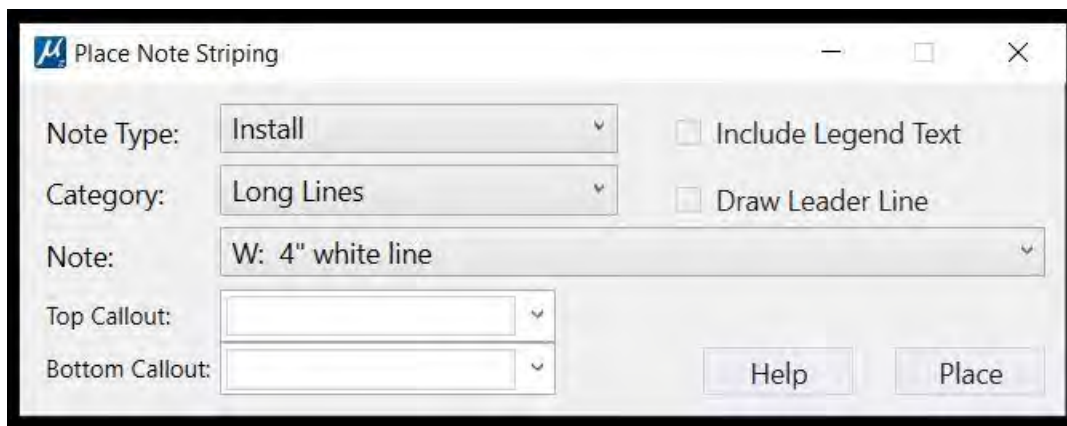

9.4 Base File Augmentation

Certain drafting standard features need to be changed or deleted in order to produce a clear, readable set of pavement marking plans. Change the following items:

Centerline: Lighten the roadway designer’s centerline to make sure the pavement marking lines stand out and are clear on the plan sheets. Change the weight to “0” and the style to “1.” Tick marks and stationing remain the same, as shown in Figure 9.4.

Create a model in the pavement marking base file called “Alignment.” Reference in the roadway alignment base file. Copy the alignment and change the thickness and line style. Turn off the alignment level and every other level except the tic marks and stationing in the reference file. Reference this alignment file model into plan sheets with nested references and do not allow overrides.

Arrows Indicating Direction of Traffic: Remove arrows only meant to indicate direction of traffic on the pavement marking plan sheets. This can cause confusion in the field and may result in legends installed.

Figure 9.4: Modification of Centerline

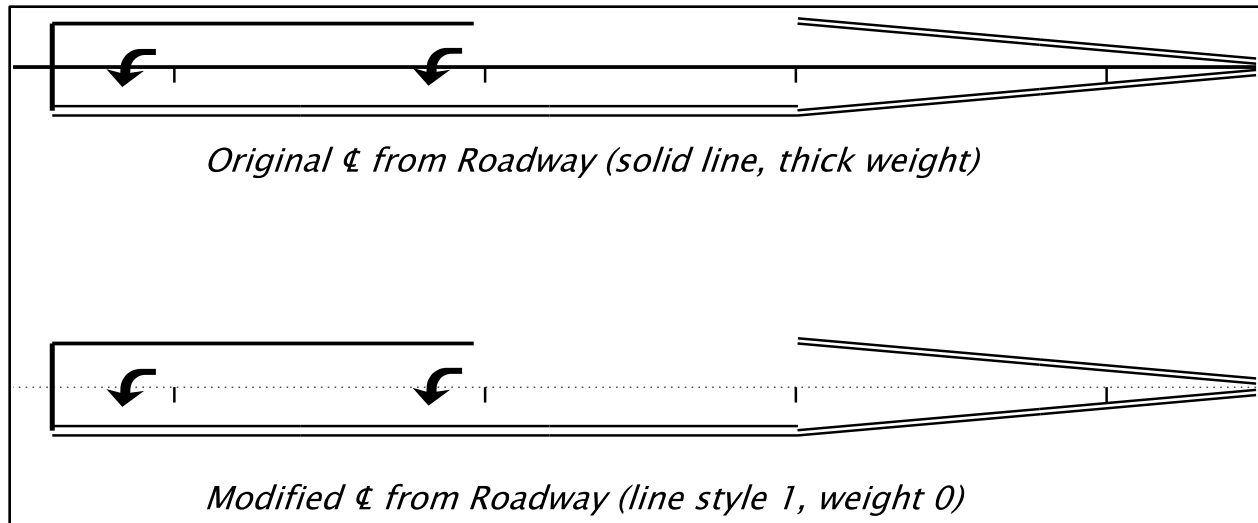

9.5 Reference Files

Sometimes you may need different reference files for designing and preparing pavement marking plans, depending on how the roadway plans are developed. The following is a list of reference files available for use. Depending on the type of the project, you may not need or use all of them.

- Survey base file (for existing features).
- Roadway base file (for new roadway features and alignment).
- Inroads alignment geometry (for tracking station and offset and determining no-passing zones).
- Roadway profile (for checking vertical alignment sight distance to determine no-passing zone markings).
- Sign base file (for checking the pavement marking layout against the sign layout).
- Signal base file (for checking the pavement marking layout against the signal layout).

9.6 Borders and Title Block

The border and title block shall be created in MicroStation from the “ODOT Plan Sheet Creation” Workflow. The “Sheet Borders” Group and the “Titleblocks” Group can be found in the “Old in Design Models Method” Ribbon. If you created a new file for your plan sheet(s) from the 2D seed file, your plan file will have the scale set to 1”=100’. To create plans with a scale of 1”=50’ simply change the scale of your drawing. This will automatically shrink the border and title block cells to the correct size for 50 scale plans.

Once border(s) with title block(s) has been placed, it should look like Figure 9.6-1

Figure 9.6-1: Border with Title Block

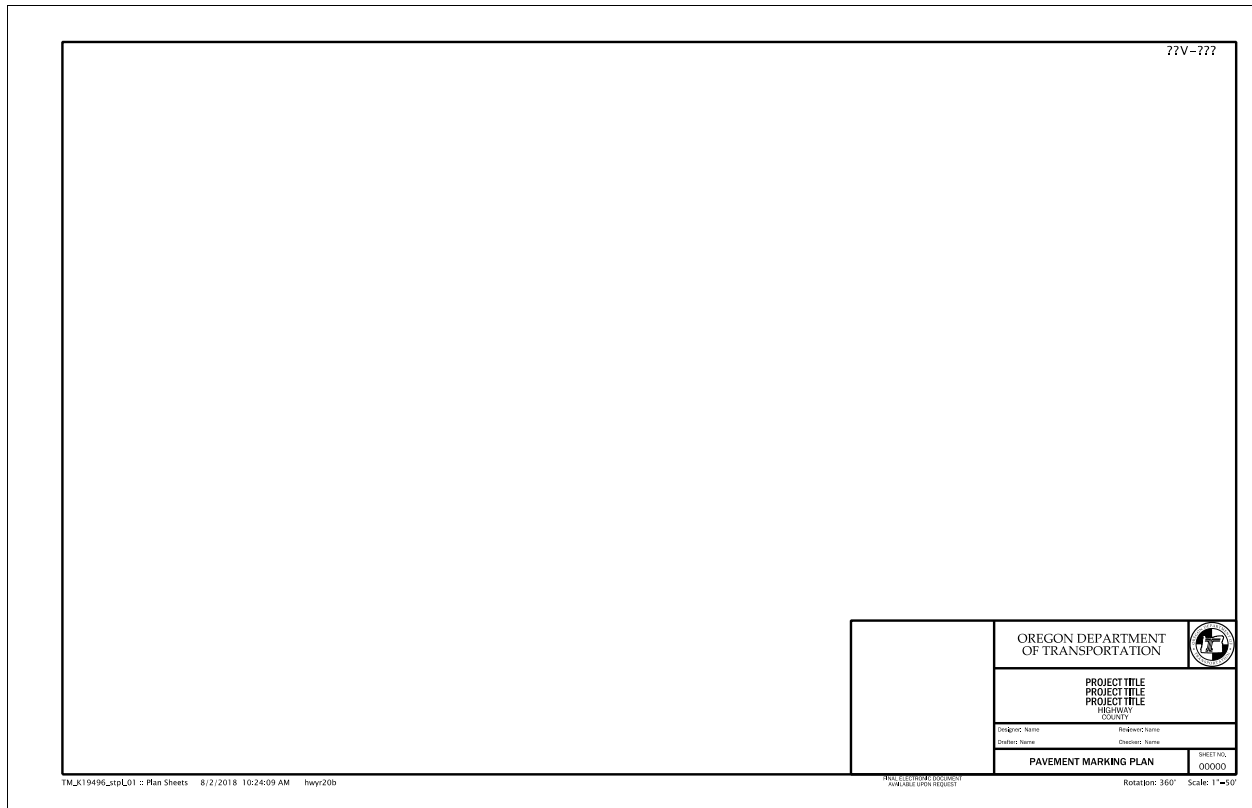

Title Block

As shown in Figure 9.6-2, a title block has six sections:

Section 1 – P.E. Seal (Stamp & Digital Signature)

The engineer of record places their seal here. See the [Contract Plans Manual](#) for further information on creating a P.E. seal/stamp in MicroStation and digitally signing plans. For any plan review distributions prior to the final signed Mylar, add a status stamp diagonally across this space over the P.E. seal/stamp.

Section 2 – Consultant or Region Information

Place any company or ODOT section logos in this section. The logo may be a graphic, text, or a combination of both. Each ODOT region Design Section has a unique logo.

Use the “PAVEMENT MARKING REMOVAL PLAN” title if the project contains removal plans; however, most do not.

You may omit the “PAVEMENT MARKING DETAILS” sheet if the content of what is normally shown on the detail sheet can be placed on the first sheet of the “PAVEMENT MARKING PLAN” (typically for a small project).

Section 6 – Sheet Numbering

Each sheet shall have a sequential number starting with Q. See [Contract Plans Manual](#) for numbering of sheets.

9.7 Sheet Size and Scale

All contract pavement marking plan sheets shall be plotted B size (11”x17”). Plan sheets should have a sheet scale of 1200 (1”=100’) for rural highways or 600 (1”=50’) for urbanized highways. Typically the pavement marking plans use the same scale as the roadway plans. Plot the design acceptance, preliminary and advance plans to PDF file for review within the ProjectWise milestone folders. The engineers of record will digitally sign each PDF page of the PS&E plans, once printed.

An Oregon-registered professional engineer shall seal and digitally sign each final PDF plan sheet.

9.8 V-Number

All pavement marking plans shall have the V-number drafted in the upper right hand corner of the plans. The V-number is the basis for archiving plans; archive the pavement marking plans with the roadway plans. During the final stages of the project, the roadway designer or specifications writer assigns the V-number.

9.9 Order of Pavement Marking Plans

The Contract Plans Development Guide establishes the order in which the pavement marking plans land within the contract plan set.

Order the three different titles of pavement marking plan sheets as follows:

- “PAVEMENT MARKING DETAILS”
- “PAVEMENT MARKING PLAN”
- “PAVEMENT MARKING REMOVAL PLAN”

Chapter 10: Drafting Standards – Plan Sheet Specific

10.1 Pavement Marking Details

As mentioned in Chapter 9, a pavement marking plan set for a project may or may not require a pavement marking details sheet, depending on the scope and the size of the project. Small and simple projects may not require a pavement marking details sheet. On the other hand, it may be beneficial to use a pavement marking details sheet for large complex projects.

If used, the pavement marking details sheet should include the following:

- All definitions for bubbles shown on the pavement marking plans and pavement marking removal sheets.
 - All pavement marking plans and pavement marking removal plans should contain a general note referring the reader back to where the legend is located, as shown in Figure 10.1-1.
- A list of standard drawings that accompany the striping plans.
 - If there is no pavement marking details sheet, show the list of standard drawings only on the first page of the pavement marking plans.
- General notes that apply to the pavement marking plans.
- Other items as necessary.
 - For example, if a project includes a special spacing for raised pavement markers not covered by any standard drawings, include a detail in pavement marking details sheet.

If there is no pavement marking details sheet for a project, include the bubble note definitions in the pavement marking plans. See Figure 10.1-2 for some commonly used bubble notes. The legend must contain:

- Definitions for every bubble shown on the pavement marking plans.
- Annotations for each bubble or rectangle shown.
- Definitions of abbreviations used on the plan sheet or in the legend.













Figure 10.1-1: Note used on Pavement Marking Plan Sheet Referring the Reader to the Pavement Marking Legend

See sheet QA01 for legend and general notes.

	OREGON DEPARTMENT OF TRANSPORTATION	
	PROJECT TITLE PROJECT TITLE PROJECT TITLE HIGHWAY COUNTY	
	Designer: Name	Reviewer: Name
	Drafter: Name	Checker: Name
	PAVEMENT MARKING PLAN	SHEET NO. 00000

FINAL ELECTRONIC DOCUMENT
AVAILABLE UPON REQUEST
Rotation: 0° Scale: 1"=100'

Figure 10.1-2: Commonly Used Bubble Notes

<u>LEGEND</u>	
	Inst. 4" white line
	Inst. 8" white line
	Inst. 8" white dotted line
	Inst. two-way left turn positioning guide
	Inst. double no-pass positioning guide
	Retain and protect extg. 12" white stop bar
	Retain and protect extg. staggered continental crosswalk
	Retain and protect extg. narrow double no-pass
	Remove extg. 4" white line
	Remove extg. 8" white line
	Remove extg. 8" white dotted line
	Remove extg. two-way left turn
	Remove extg. double no-pass

10.2 Pavement Marking Plan

Pavement marking plans typically show all pavement markings along with other relevant elements or information, such as edge of pavement or curb line, centerlines with stationing

when available, driveways, sidewalk, sidewalk ramps, highway/street names, north arrow and other features as needed. Draw pavement marking plans at a scale of 100:1 for rural highways and 50:1 for highways within urban areas. Generally pavement marking plan sheets should match roadway plan sheets in scale and limits.

The pavement marking plan shall include:

- Location of all longitudinal and transverse pavement markings.
- Bubble(s) and leader(s) for each installed, removed, or retained item.
- Definitions of bubble(s), if not shown on a pavement marking details sheet.
- General notes, if not shown on a pavement marking details sheet.

Example pavement marking plan sheets are shown in Appendix D.

Basic Drafting Standard Requirements

Follow the roadway drafting standards for border, title block, line weight, and font, as detailed in the [Contract Plans Manual](#), except where modified within this document.

Lane Line Dimensions

Show lane line dimensions when possible. When shown, the dimensioning should be consistent with the roadway standard, as detailed in the Contract Plans Development Guide and shown on the roadway plans. Figure 10.2-1 shows an example.

Figure 10.2-1: Lane Line Dimensions Shown in Pavement Marking Plans

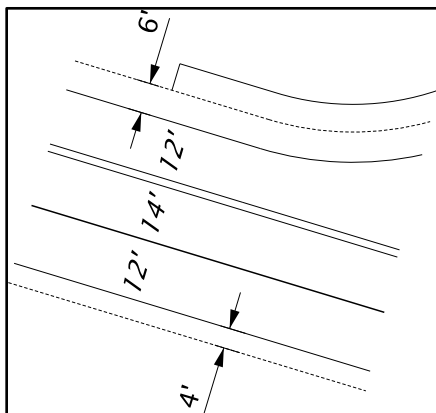

Show lane line dimensions at the beginning and ending taper points of a longitudinal line, as shown in Figure 10.2-2. For tapers that do not follow the roadway cross-section, include an additional note so those in the field are aware the pavement marking deviation is intentional (See note 3 of Figure 10.2-3).

Figure 10.2-2: Lane Line Dimensions Shown at Taper Point

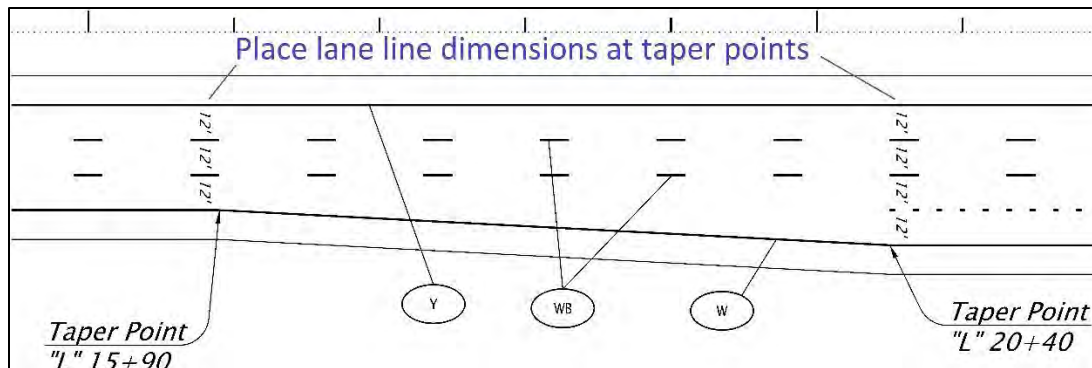

Figure 10.2-3: General Notes for Lane Line Dimensions at Taper Points

General Notes:

1. Match points to existing striping and station call-outs are approximate and shall be field verified. Exact locations are to be determined by the Engineer.
2. Removal of existing pavement markings shown is approximate and shall be field verified. Exact locations are to be determined by the Engineer.
3. Taper point intentionally deviates from cross-section as shown in the roadway plans.

If the roadway geometry is complex and includes numerous tapers, showing the dimensions on the plan sheet can become cluttered and unreadable. In these cases, there are a few options available:

- Add a general note to inform the contractor, as well as the project manager, that in-depth layout information will be provided by the engineer of record during construction.
- Change the plan's scale.
- Including a detail at a more appropriate scale with a note on the plan sheet referencing the detail.

When in-depth layout information is provided during construction, use note 3 of Figure 10.2-4. When using this note, it is critical to have good communications with the project manager both before and during construction. This note may be used in rare cases when the pavement marking deviates from the cross-section shown in the roadway plans.

Figure 10.2-4: Lane Line Dimension Note

General Notes:

- 1. Match points to existing striping and station call-outs are approximate and shall be field verified. Exact locations are to be determined by the Engineer.*
- 2. All permanent pavement striping is Method "B" (non-profile) except as noted. See Section 00865 in Special Provisions.*
- 3. Engineer of Record to provide in-dept layout details prior to installation.*

Removal Notes

When removing a pavement marking (longitudinal or transverse) and replacing it with a different line type or transverse marking in the exact same location, the first bubble note in the string is always the removal information. The removal note will be rectangular with an "RX" for removal. The installation information follows, in an oval bubble, indicating the marking type (see Figure 10.2-5).

Figure 10.2-5: Bubble Note for Removal and Replacement of Pavement Markings

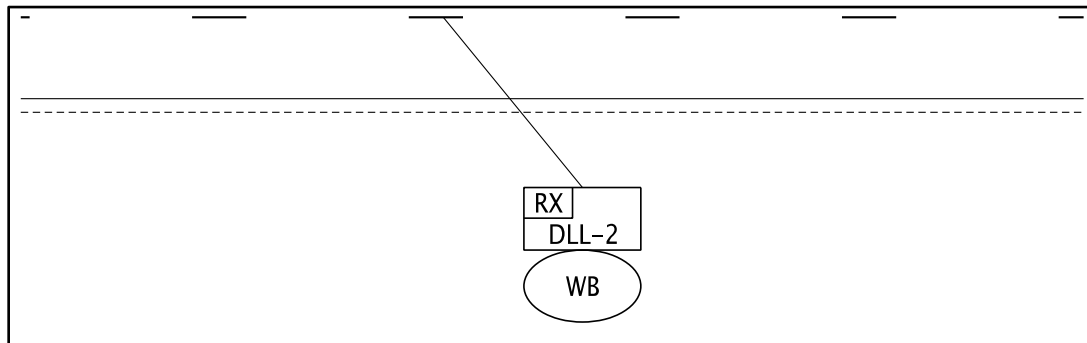

If a pavement marking (transverse or longitudinal) will be replaced with a different line type or transverse marking, but will not be installed at the exact same location, use individual bubble notes with individual leader lines for both removal and installation, as shown in Figure 10.2-6.

Figure 10.2-6: Bubble Note for Removal of Pavement Markings

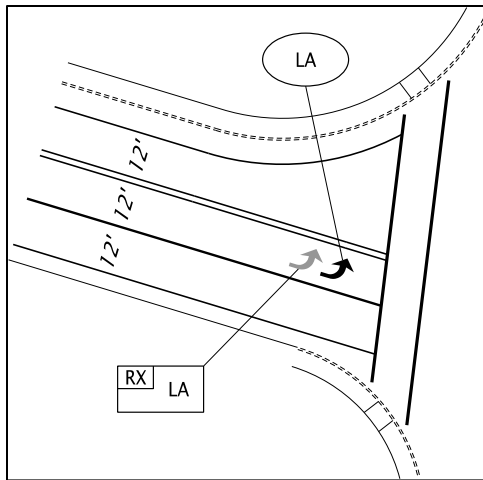

If removal of pavement markings is extensive, showing removal in conjunction with installation of pavement markings can make the plan sheets cluttered and hard to read. In these cases, separate the removal notes from the installation notes by creating a pavement marking removal plan sheet. See Section 10.3 “Pavement Marking Removal Plan” for more information and examples.

Station Call-Out Notes

In order to prevent scaling error in the field during construction, stationing must be used to identify certain situations in the pavement marking plans. A general note stating, “Match points to existing pavement marking and station call-outs are approximate and shall be field verified” is required. Use a leader line with an arrow head to indicate the location of station call-out, with the station call out text placed at 0 degree rotation.

Situations that require identification with stationing (or mile point if stationing is not present) include:

- The beginning and ending taper points of a longitudinal line. For tapers that do not follow the roadway cross-section, include an additional note so those in the field are aware the pavement marking deviation is intentional.
- Ending of white broken line for a lane reduction transition.
- Beginning of a different line type, e.g., beginning of wide dotted lane line for a drop lane.
- Ending of dotted lane line for freeway entrance ramp with parallel acceleration lane.
- Match points to existing pavement marking.
- Taper point and gore point of entrance or exit ramp.
- Ending point of pavement marking work that extends outside of the project limits.
- Left turn channelization reversing curves (option 1).

Station call-out notes may be used in other situations, as appropriate. However, do not use station call-out notes excessively. See Figure 10.2-7 for examples of station call-out notes for various situations.

Figure 10.2-7: Station Call-Outs for Different Situations

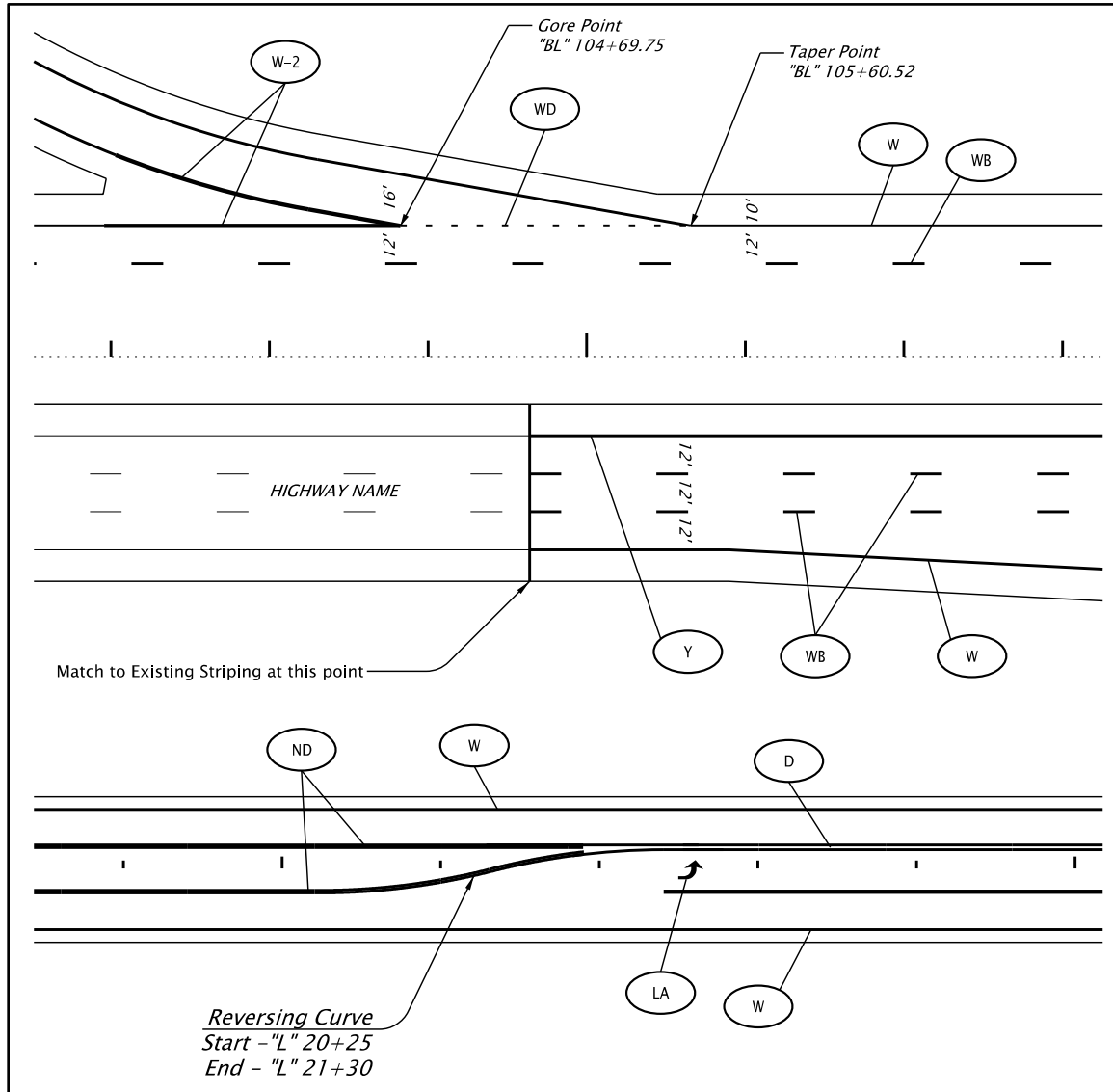

Matching to Existing Pavement Marking

At locations where the new pavement marking must tie in with existing pavement marking, be sure to verify in the field what is upstream of the match in location. In many instances, pavement markings outside the project limits must also be modified in order to comply with standards. For example, the construction limits for installing a new left turn lane will normally end at the end of the taper section. If the existing pavement marking at the point of the match in

does not have a one direction no-passing marking for traffic approaching the left turn lane, then one must be installed. See “Work Required Beyond Project Limits” subsection for more information on how to show this work on the plan sheets.

On the plan sheets, the match point should show a transverse line with a station call-out and large arrow, as shown in the middle example of Figure 10.2-7. The pavement marking beyond the match point should not be shown unless it would help clarify placement of the new pavement marking.

Length & Distance Call-Out Notes

Certain pavement marking design features shall have the length explicitly stated on the plan sheets, rather than allowing the contractor to scale the drawing. Show this by including a measurement either above or below the bubble note; use the ODOT drafting menu to add the measurement.

The pavement marking design features that require a stated length include:

- The 8” white channelizing line (W-2) length used for left and right turn lanes.
- The gap length used for an “Option 2” left turn lane design.
- The distance from an advance stop bar to a crosswalk (this distance is detailed on the stop bar bubble note.)

Length and distance call-out notes may be used in other situations, as appropriate. However, do not use call-out notes excessively. Figure 10.2-8 shows examples of length and distance call-out notes.

Figure 10.2-8: Length and Distance Call-Out Notes

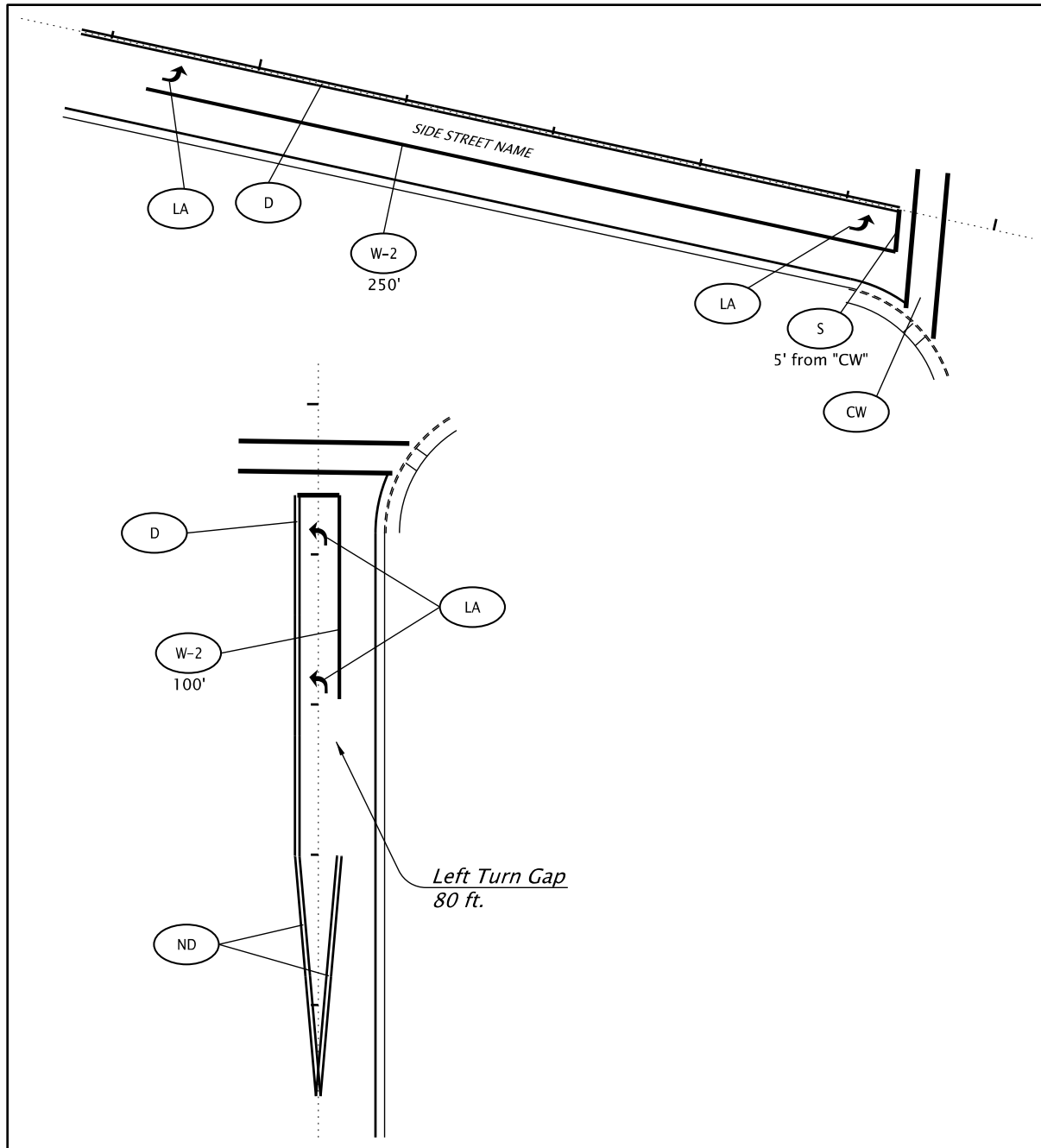

General Notes

A typical pavement marking plan set should have some general notes that provide specific information regarding the installation of pavement markings for the project. As mentioned earlier, show general notes on the striping details sheet or only on the first page of striping plan

sheets, if striping details sheet is not used. General notes will vary depending on the scope of the project. Commonly used general notes for pavement marking plans include:

- All longitudinal pavement markings shall be Method ___.
- All bicycle lane stencils shall be Type B-HS, preformed, fused, thermoplastic film high skid pavement markings. All other transverse markings shall be Type _____.
- Match point to existing striping and station call-outs are approximate and shall be field verified.
- Removal of existing marking is approximate and shall be field verified.

Multiple Pavement Marking Materials

Use of more than one type of pavement marking material for longitudinal and/or transverse markings in a single project is acceptable. Labeling material types in the plan sheet is not needed, if only one type of material for longitudinal markings and one type of material for transverse markings are used. The specifications alone will address the different materials used for longitudinal and transverse markings.

When a project specifies use of multiple methods or types of pavement markings, the method or type that comprises the majority of the installation is not labeled and the minority pavement marking type(s) are labeled either above or below the bubble note. A general note accompanies the drawing as shown in Figure 10.9 and is detailed in the appropriate section of the special provisions.

Figure 10.2-9: Call-Out and Note for Multiple Marking Materials

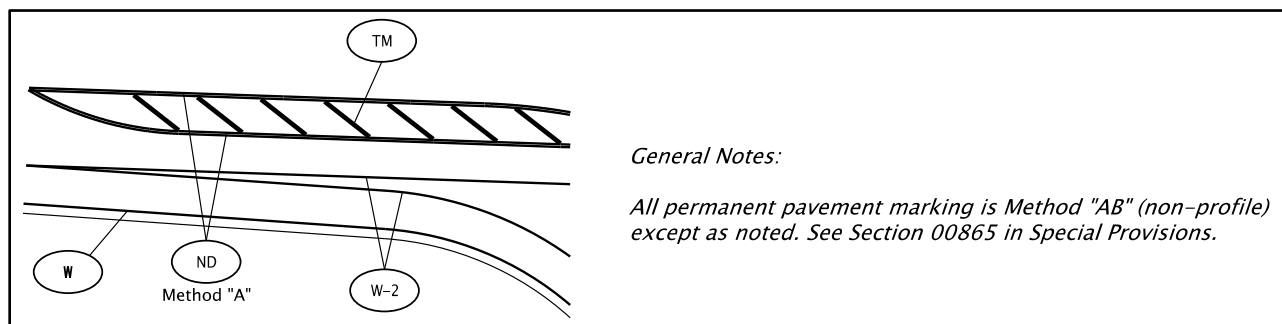

Other Traffic Control Devices

Other traffic control devices may be shown on the pavement marking plan sheets. These include:

- Surface mounted tubular markers.
- Raised pavement markers on raised curb.
- Rumble strips.

Cells for these devices are available from the ODOT Drafting menu. However, no standard bubble note is available. Designers need to include callouts for these items whenever present, with appropriate spacing/type, as shown in Figure 10.10. Be aware that rumble strips shown in plans may make the plans too busy and are normally shown in details rather than plan sheets.

Figure 10.2-10: Call-Out for Other Traffic Control Devices

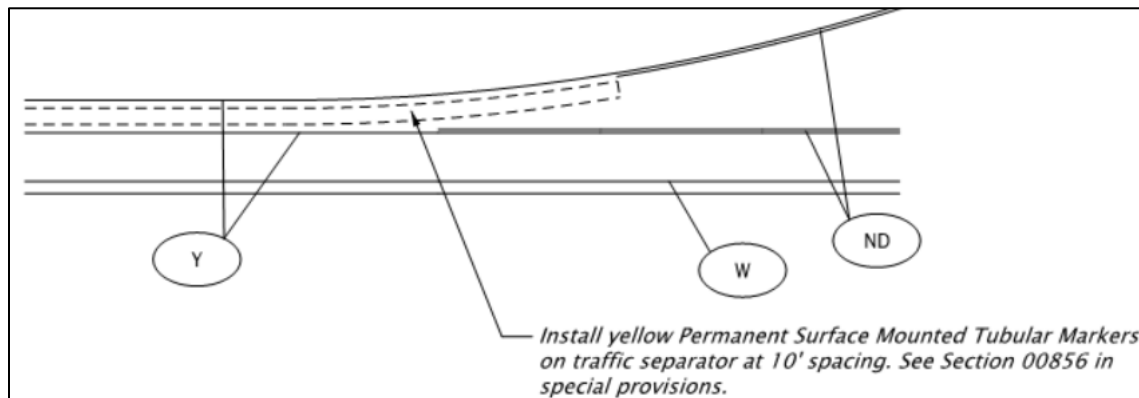

Work Required Beyond Project Limits

“Match existing pavement marking” with brackets is typically used to indicate the paving limits. However, it may be necessary to change some or all of the existing pavement markings outside of the paving limits. When work extends outside of the project limits, label any striping to be modified outside of the paving limits with approximate beginning and ending stationing. Include any applicable contractor directions, such as “remove existing pavement marking before installing new pavement marking.”

Only show the existing pavement marking located outside the project limits, if it is necessary to clarify placement of the new pavement marking (and use hatching), otherwise leave it out, as shown in Figure 10.2-11. The first example shows the standard way to show work beyond project limits. The second example shows the alternate way to show work beyond project limits with hatching.

Figure 10.2-11: Labeling for Work Outside the Project Limit

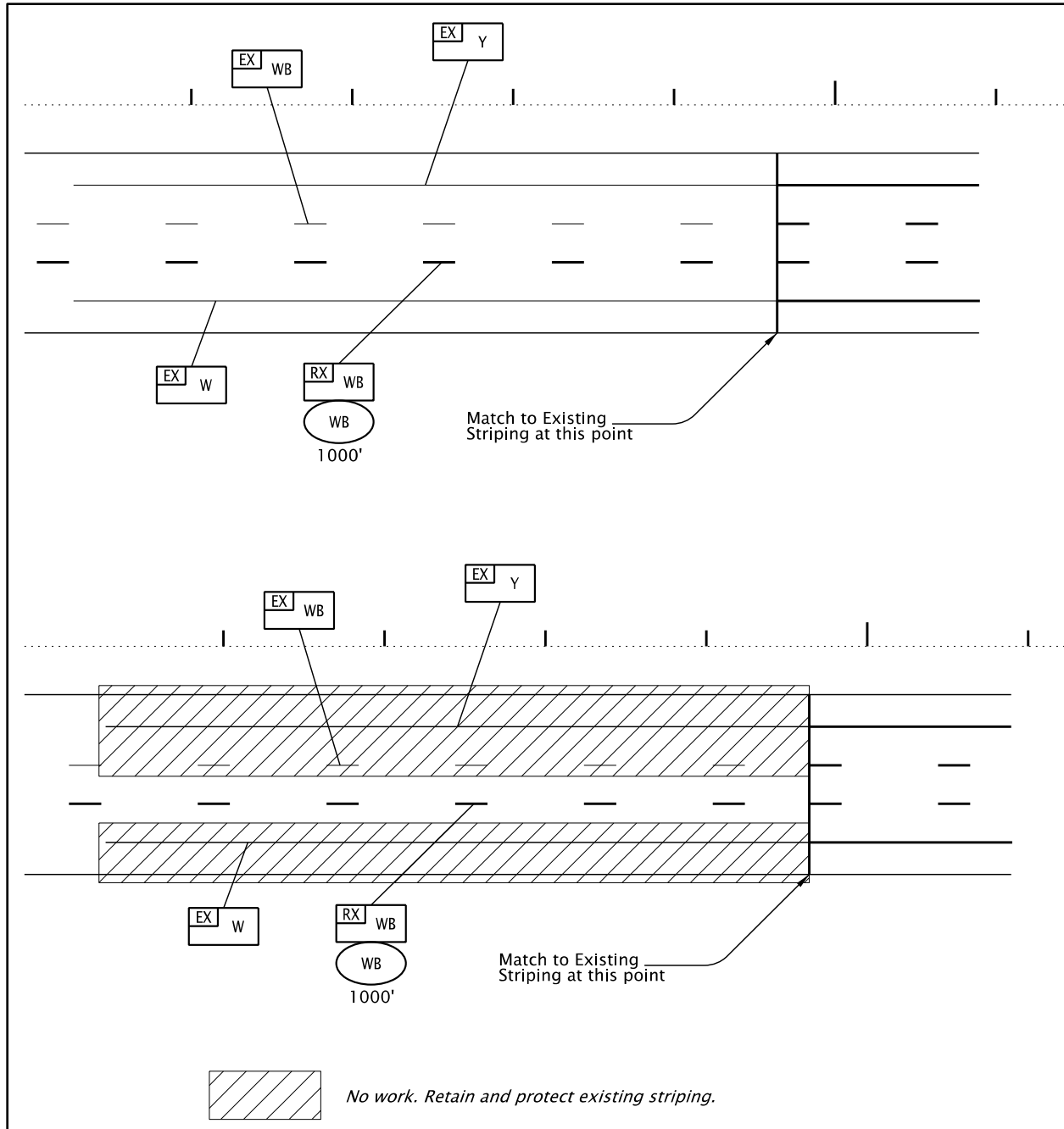

10.3 Striping Removal Plan

Including pavement marking removal plan sheets may provide clarity. If used, striping plan sheets shall include:

- Location of all longitudinal and transverse pavement markings to be removed.

- Match points to the existing pavement marking.
- Appropriate bubble(s) and leader(s) for each removed or retained item.

Another option to show removal of pavement marking is to clearly indicate the “work area” on the plan sheet where removal will occur. Do so by hatching the “no-work area” on the plan sheet. Place a note on the plan sheet, indicating estimated quantities, as shown in Figure 10.3. Only the new pavement marking is shown in the work area most of the time. It may be helpful to show existing pavement markings greyed back in certain situations (when removals and new markings are not in the same location, and when matching into existing markings.)

Figure 10.3: Note for Pavement Marking Removal Sheets

Remove existing pavement markings within the work area shown on this sheet prior to installing new pavement markings. Est. Quantity = XX ft, XX each, XX sq ft.

10.4 Pavement Marking Design Shown on Other Discipline’s Plan Sheets

In the past, ODOT did not typically create separate pavement marking plan sheets for simple projects without much pavement marking work. In these cases, the pavement marking details might have been included on the signing plan sheets, roadway plans or signal plans. While this practice may save some time during the design process, it is no longer allowed for the following reasons:

- It violates contract plan format expectations. The contractor or project manager’s office may miss a pavement marking detail shown on another discipline’s plan sheet, because they don’t expect it to be there. Or, they could misinterpret a detail shown on a signal plan as a pavement marking work item. In either case, the scope of the pavement marking work is not clear and can result in wasted time and money during construction. Contract plans should be clear with each disciplines’ work items in separate plan sheets, in the expected format.
- Archiving the combination plan sheets is problematic, as we archive plans in one location.

10.5 Temporary Striping Plan Sheets

We typically show temporary pavement markings in the traffic control plan sheets, if needed for complex layouts. Use the permanent pavement marking tools in MicroStation for creating temporary pavement marking. For simple temporary pavement marking, the Specification Section 00220 and 00225 may be adequate to address the needs on your project.

For temporary pavement markings during or immediately following road construction, MUTCD Sections 6F.71-73 applies, except for low volume road applications. Note: It is

allowable to indicate no-passing zones with signs only for periods of up to three days. Edge lines are normally not marked in temporary applications.

See the Traffic Control Plans Design Manual for more information about how to show temporary pavement marking in contract plans.

Appendix A – References

1. ODOT Pavement Marking Web Page:
<https://www.oregon.gov/odot/Engineering/Pages/Striping.aspx>
2. ODOT Traffic Line Manual:
https://www.oregon.gov/odot/Engineering/Documents_TrafficStandards/Traffic-Line-Manual.pdf
3. Standard Drawings and Standard Details:
<https://www.oregon.gov/odot/Engineering/Pages/Standards.aspx>
4. ODOT Traffic Manual:
https://www.oregon.gov/odot/Engineering/Docs_TrafficEng/Traffic-Manual-2020.pdf
5. ODOT Standard Specifications:
https://www.oregon.gov/odot/Business/Pages/Standard_Specifications.aspx
6. Boilerplate Special Provisions:
https://www.oregon.gov/odot/Business/Pages/Standard_Specifications.aspx
7. Technical Guidance: <https://www.oregon.gov/odot/Engineering/Pages/Technical-Guidance.aspx>
8. Railroad Crossing Order – call Rail Crossing Safety Manager at 503-986-4273.
9. Contract Plans Development Guide:
<https://www.oregon.gov/odot/Engineering/Pages/CP-Development-Guide.aspx>
10. ODOT Official Bid Item List:
https://www.oregon.gov/odot/Business/Pages/Standard_Specifications.aspx
11. ODOT Average Bid Item Prices:
https://www.oregon.gov/odot/Business/Pages/average_bid_item_prices.aspx
12. STIP Web Page: <https://www.oregon.gov/odot/STIP/Pages/index.aspx>
13. Microstation Workspace Download page (for consultants):
<ftp://ftp.odot.state.or.us/isb/appeng/MicroStation/V8i/>
14. Specification Technical Resource List:
https://www.oregon.gov/odot/Business/Specs/technical_resource_list.pdf
15. Traffic Control Plans Design Manual:
<https://www.oregon.gov/odot/Engineering/Pages/TCP-Manual.aspx>
16. Manual on Uniform Traffic Control Devices:
<https://www.oregon.gov/odot/Construction/Pages/Construction-Manual.aspx>
17. Construction Manual: <https://www.oregon.gov/odot/Construction/Pages/Construction-Manual.aspx>
18. Phase Gate Delivery Manual:
<https://www.oregon.gov/odot/Business/PCOManuals/Phase-Gate-Delivery-Manual.pdf>

Appendix B – Designer Checklist

Verify the following items prior to completing the project:

Design Related Items	Check
Have state traffic engineer approvals been obtained (See Traffic Line Manual, delegated authority for more info)?	
Have region traffic engineer approvals been obtained (See Traffic Line Manual, delegated authority for more info)?	
Have the plans been reviewed by the region Traffic Section?	
Have the plans been reviewed by the region pavement marking crew manager?	
Has the region Pavement marking crew manager approved of the material type used on the project?	
Are pavement markings needed outside the project limits (no-passing pavement marking prior to left turn refuges, etc.)?	
Have the technical directives, bulletins, advisories been checked to ensure most current policies and practices are used?	
Is any detail sheet containing any unique project bubble notes needed? Has the traffic markings & sign engineer has been notified if different from Traffic Line Manual?	
Is a pavement marking removal plan necessary?	
Do the signing plans match with the pavement marking plans (lane reductions, RxR crossings, lane use at intersections, school crossings, STOP signs, YIELD signs, etc.)?	
Are multiple material types required? Is this noted in the plans & callouts?	
Are surface mounted tubular markers required? Or RPMs? Have they been shown and called out in the plans?	
Do the striping plans match with the roadway plans (tapers, lanes, etc.)?	
Will new pavement marking on project match into existing pavement marking?	
Have all the proper standard drawings been selected? And listed in the plans?	
Have all the proper bid items been selected?	
Is any unique language required in the special provisions?	
Has unique language in the special provisions (if used) been approved by the technical expert?	
Do the standard drawings on the index sheet match the standard drawings on the first sheet of the pavement marking plans?	

Drafting Related Items	Check
North arrow has been shown on all sheets	
Bubble notes match current Standard Drawings TM500-TM504	
Appropriate levels have been turned off	
Centerline (weight and line style) has been changed to not conflict with pavement marking	
Station call-outs for all items requiring a call-out	
Stationing is present on all sheets	
V number is present on all sheets	
Project name and info in the title block matches the title sheet title block	
Engineer's stamp bears correct expiration date	
All sheets are numbered (QA..., QB..., QC... etc.)	
All roadway alignments are labeled by name	
Bubble notes placed outside the roadway width	
Match lines shown for all areas where new pavement marking is to match to existing pavement marking	
Edge of pavement, ADA ramps, sidewalk, non-traversable medians/island, barriers, centerline shown on plans	
Lane dimensions shown on plans, or general note stating "more in-depth layout contact EOR"	
Critical lengths and measurements have been shown on the plans (channelizing line for left turn refuges, advance stop bar placement, etc.)	
Multiple material types shown appropriately along the leader line of the bubble note	
Title block is correct and filled out correctly	
Referenced standard drawings are shown on the first pavement marking plan sheet	

Appendix C – Example Project Title and Index Sheets

Figure C-1: Example Title Sheet

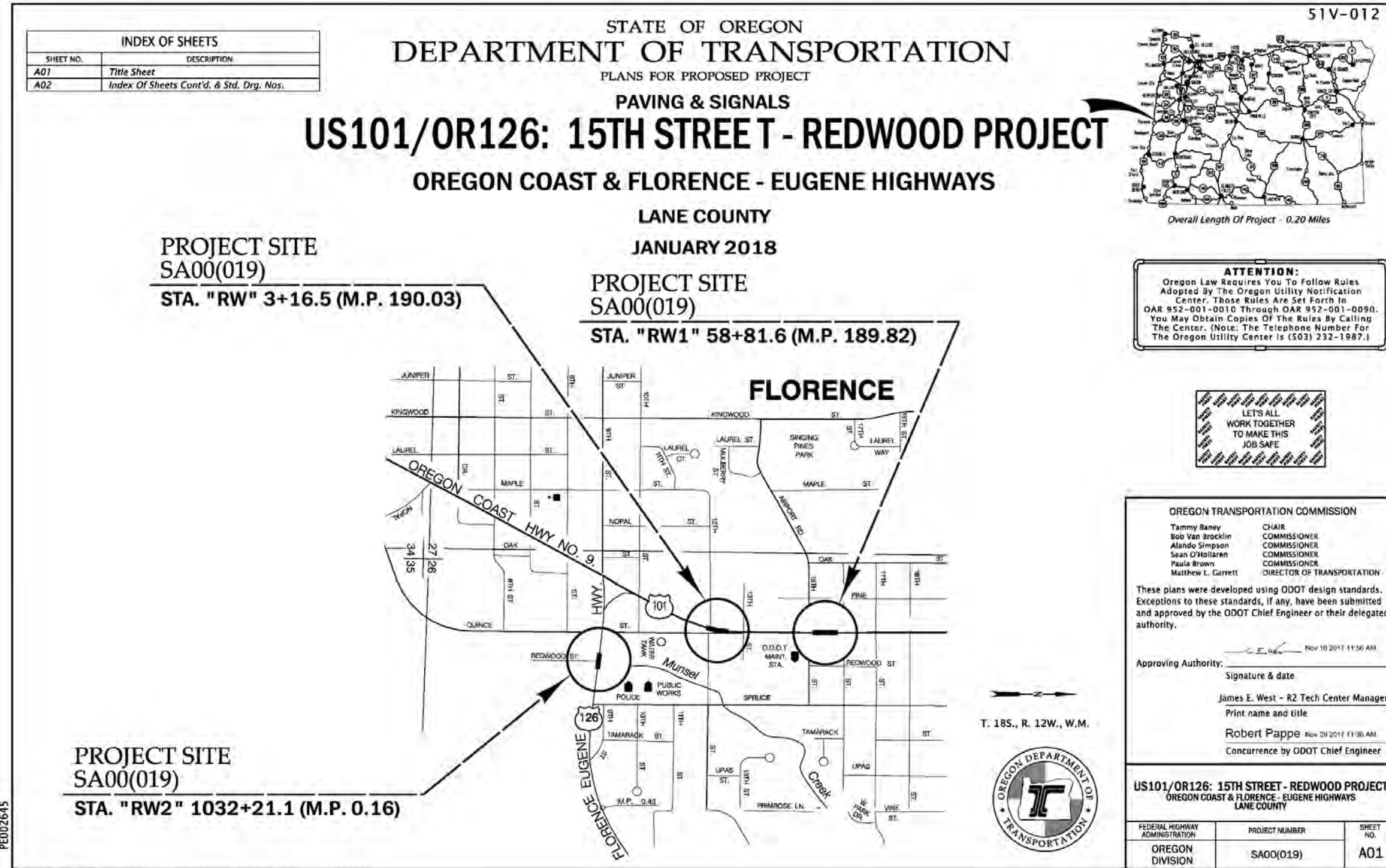

Pavement Marking Design Guidelines

Figure C2: Example Index Sheet

51V-012

INDEX OF SHEETS, CONT.	
SHEET NO.	DESCRIPTION
BA01, BA02	Typical Sections
BB01 Thru BB10 Incl.	Curb Ramp Details
C01	Alignment
C02	General Construction
C03	Alignment
C04, C05	General Construction
EA01 Thru EA10 Incl.	Traffic Control Plan
PERMANENT SIGNING	
LA01, LA02	Signing Plan
LB01 Thru LB03 Incl.	Sign Details
LC01, LC02	Sign & Post Data Table
SIGNAL PLANS	
MA01	Flashing Beacon Plan
MA02	Existing Utilities Plan
MA03	Flashing Beacon Plan
MA04	Existing Utilities Plan
MA05	Flashing Beacon Plan
MA06	Existing Utilities Plan
MB01 Thru MB03 Incl.	Signal Plan Details
PERMANENT PAVEMENT MARKINGS	
QA01, QA02	Pavement Marking Plan

Standard Drg. Nos.

- | | | | |
|-------|--|-------|---|
| RD364 | - Concrete Inlets Type G-1, G-2, G-2M & G-2MA | TM670 | - Wood Post Sign Supports |
| RD700 | - Curbs | TM671 | - 3 Second Gust Wind Speed Map |
| RD705 | - Islands | TM675 | - Extruded Aluminum Panels |
| RD710 | - Accessible Route Islands | TM676 | - Sign Attachments |
| RD720 | - Sidewalks | TM677 | - Sign Mounts |
| RD753 | - Pay Limit For Retrofit Sidewalk Ramp Placement Options Large Radii | TM678 | - Secondary Sign Mounting Details |
| RD754 | - Sidewalk Ramp And Turning Space (For Ends Of Sidewalk) | TM679 | - Signal Mast Arm Street Name Sign Mounts |
| RD755 | - Sidewalk Ramp Details | TM680 | - Signal Pole Mounts |
| RD757 | - Sidewalk Ramp Placement Options Large Radii | TM681 | - Perforated Steel Square Tube (PSST) Sign Support Installation |
| | | TM687 | - Perforated Steel Square Tube (PSST) Anchor Foundation |
| | | TM688 | - Perforated Steel Square Tube (PSST) Slip Base Foundation |
| TM200 | - Sign Installation Details | TM800 | - Tables, Abrupt Edge And PCMS Details |
| TM201 | - Miscellaneous Sign Placement Details | TM820 | - Temporary Barricades |
| TM204 | - Flag Board Mounting Details | TM821 | - Temporary Sign Supports |
| TM206 | - Sign Bracing Detail | TM822 | - Temporary Sign Supports |
| TM212 | - Signing Details Oregon Route Signs | TM843 | - Multi-Lane Signalized Intersection Details |
| TM223 | - Conventional Roads Directional Sign Layout Street Name Signs | TM844 | - Temporary Pedestrian Access Routing |
| TM457 | - Vehicle, Pedestrian Signal And Pushbutton Mounting Option Details | TM850 | - 2-Lane, 2-Way Roadways |
| TM458 | - Pedestrian Ramp Placement Details | TM851 | - Non-Freeway Multi-Lane Sections |
| TM467 | - Pedestrian Signal And Pedestrian Pushbutton Details | | |
| TM500 | - Pavement Marking Standard Detail Blocks | | |
| TM501 | - Pavement Marking Standard Detail Blocks | | |
| TM503 | - Pavement Marking Standard Detail Blocks | | |
| TM521 | - Durable & High Performance Pavement Markings Surface & Groove Installed Non-Profiled | | |
| TM530 | - Intersection Pavement Markings (Crosswalk, Stop Bar & Bike Lane Stencil) | | |
| TM531 | - Turn Arrow Marking Details | | |
| TM560 | - Alignment Layout: General | | |
| TM561 | - Alignment Layout: Left Turn Lane, Centerline & Medians | | |

R/W Map No. 1R-4-1257

Standard Drawings located on the web at:
http://www.oregon.gov/ODOT/HWY/ENG/SERVICES/pages/standard_drawings_home.aspx



OREGON DEPARTMENT OF TRANSPORTATION		
US101/OR126: 15TH STREET - REDWOOD PROJECT OREGON COAST & FLORENCE - EUGENE HIGHWAYS LANE COUNTY		
FEDERAL HIGHWAY ADMINISTRATION	PROJECT NUMBER	SHEET NO.
OREGON DIVISION	SEE SHEET A01	A02

Appendix D – Example As-Constructed Plans

Figure D-1: Example As-Constructed Plan Sheet (1)

Contract Plans

42V-194

INDEX OF SHEETS	
SHEET NO.	DESCRIPTION
1	Title Sheet
1A	Index Of Sheets Cont'd. & Std. Drg. Nos.

NOT REVISED AS CONSTRUCTED
Ray Cranston
RAY CRANSTON, P.L.S.

DATE 11-17-10

STATE OF OREGON
 DEPARTMENT OF TRANSPORTATION
 PLANS FOR PROPOSED PROJECT
GRADING, PAVING & SIGNALS
US20 @ AIRPORT ROAD SEC. (LEBANON)
SANTIAM HIGHWAY
 LINN COUNTY
 OCTOBER 2009

ORIGINAL

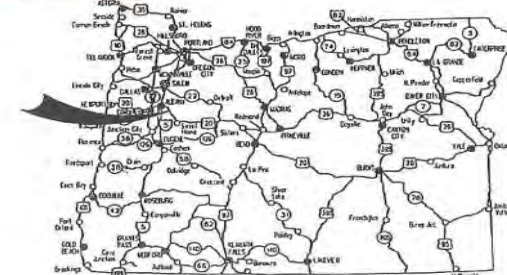

Overall Length Of Project - 0.10 Miles

ATTENTION:
 Oregon Law Requires You To Follow Rules Adopted By The Oregon Utility Notification Center. Those Rules Are Set Forth In OAR 952-001-0010 Through OAR 952-001-0090. You May Obtain Copies Of The Rules By Calling The Center. (Note: The Telephone Number For The Oregon Utility Center Is (503) 232-1987.)

LET'S ALL WORK TOGETHER TO MAKE THIS JOB SAFE

- OREGON TRANSPORTATION COMMISSION
- Gail Achterman, CHAIR
 - Michael Nelson, VICE-CHAIR
 - Jonice Wilson, COMMISSIONER
 - Alan Brown, COMMISSIONER
 - David Lohman, COMMISSIONER
 - Matthew L. Corrett, DIRECTOR OF TRANSPORTATION

These plans were developed using ODOT design standards. Exceptions to these standards, if any, have been submitted and approved by the ODOT Chief Engineer or their delegated authority.

By: *Sonny P.A. Chickering 09-02-09*
 Signature & date

Sonny P. Chickering - R2 Tech Center Manager
 Print name and title

A.M.N.
 Concurrence by ODOT Chief Engineer

US20 @ AIRPORT ROAD SEC. (LEBANON)
SANTIAM HIGHWAY
 LINN COUNTY

FEDERAL HIGHWAY ADMINISTRATION	PROJECT NUMBER	SHEET NO.
OREGON DIVISION	X-HPP-HSIP-SO16(041)	1

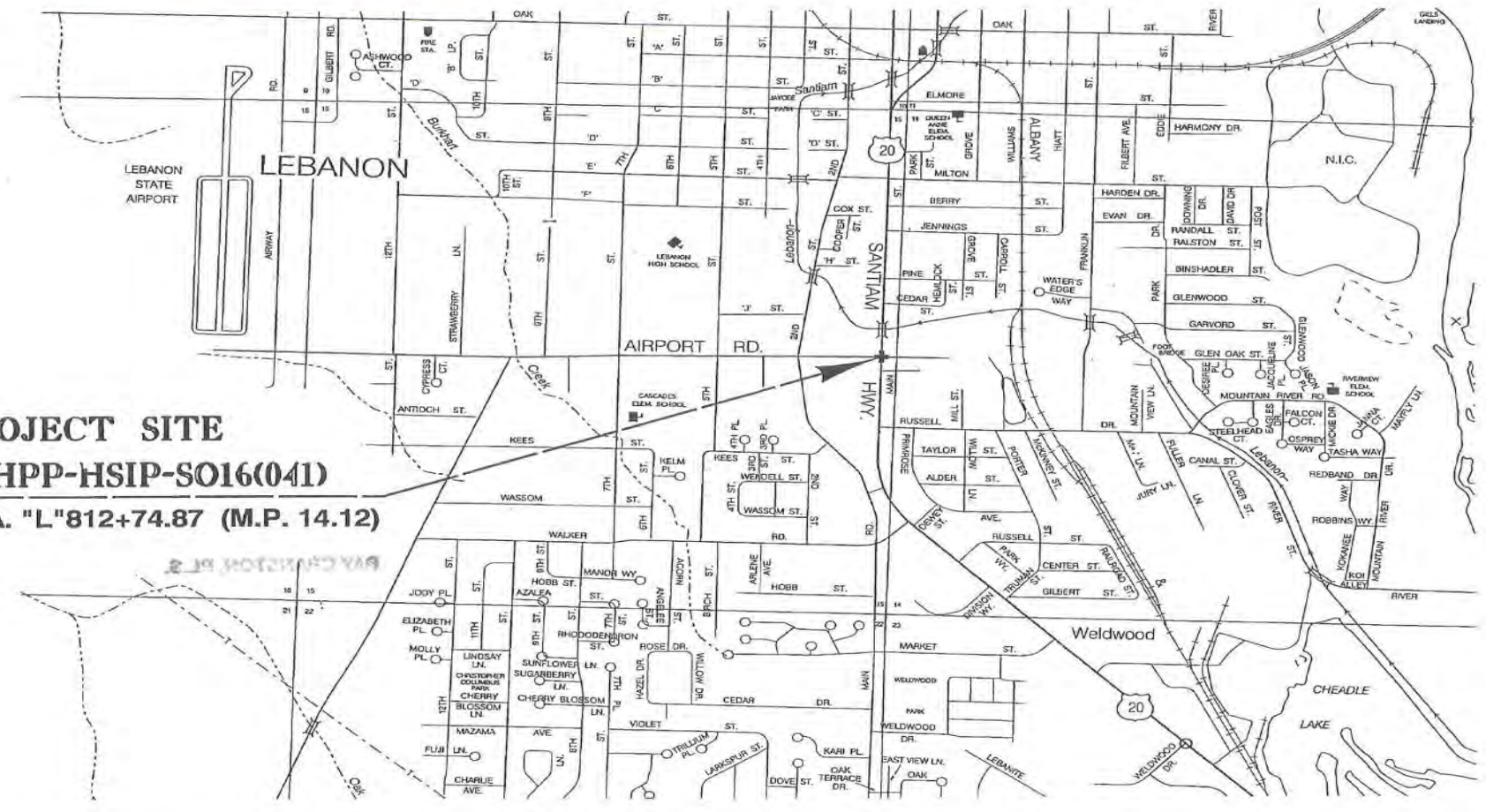

PROJECT SITE
X-HPP-HSIP-SO16(041)
STA. "L"812+74.87 (M.P. 14.12)

T. 12 S., R. 2 W., W.M.

Pavement Marking Design Guidelines

Figure D-2: Example As-Constructed Plan Sheet (2)

Contract Plans

42V-194

INDEX OF SHEETS, CONT'D.	
SHEET NO.	DESCRIPTION
2, Thru 2A-3	Typical Sections
2B	Details
3	Right Of Way Plan
3A	General Construction
3A-2	Construction Notes
3B	"DW" Line Profile
SHEET NO.	DESCRIPTION
PERMANENT PAVEMENT MARKINGS	
ST-1	Striping Plans
SHEET NO.	DESCRIPTION
PERMANENT SIGNING	
S-0B284	Signing Plan
S-0B285	Signing Detail
S-0B286	Sign & Post Data Table
SHEET NO.	DESCRIPTION
TRAFFIC SIGNALS	
15377	Signal & Detector Plan Legend
15378	Signal Plan
15379	Detector Plan
15380	Interconnect Plan
15381	Signal Removal Plan
15382	Existing Utilities
15383	Signal Plan Details

Standard Drg. Nos.

- RD140 - Roadway Cross Slopes Superelevated Sections
- RD150 - Slope Rounding
- RD300 - Trench Backfill, Bedding, Pipe Zone And Mult. Installations
- RD302 - Street Cut
- RD360 - Manhole Frame Adjustment
- RD364, RD371, RD372 - Concrete Inlets
- RD376 - Miscellaneous Drainage Structures
- RD600 - Portland Cement Concrete Pavement
- RD700 - Curbs
- RD720 - Sidewalks
- RD730, RD735 - Curb Line Sidewalk Driveways or Alleys
- RD745, RD750 - Curb Line Sidewalk Driveways - Local Jurisdictions
- RD755 - Sidewalk Ramp Details
- RD756, RD757 - Sidewalk Ramp Placement
- TM200 - Sign Installation Details
- TM201 - Miscellaneous Sign Placement Details
- TM206 - Sign Bracing Detail
- TM211 - Signing Details
- TM223 - Directional Sign Layout
- TM450 - Mast Arm Pole Details
- TM457 - Vehicle, Ped. Signal & Push Button Mounting Details
- TM458 - Pedestrian Ramp Placement Details
- TM460 - Vehicle Signal Details
- TM462 - Adjustable Signal Head Mounting Details
- TM465 - Overhead Sign, Fire Preemption & Photoelectronic Details
- TM467 - Ped. Signal And Ped. Push Button Details
- TM470 - Color Code Charts
- TM472 - Traffic Signal Junction Boxes
- TM475 - Loop Details
- TM480 - Loop Entrance Details
- TM482 - Controller Cabinet And Foundation Details
- TM485 - Service Cabinets And Service Cabinet Wiring Details
- TM488 - Terminal Cabinet Detail

Std. Drg. Nos. Contd.

- TM500, TM501, TM503 - Pavement Marking Standard Details
- TM521 - Durable Pavement Markings
- TM525 - Turn Arrow Marking Details
- TM530 - Intersection Pavement Markings
- TM570 - Traffic Delineators
- TM650, TM651, TM652, TM653 - Traffic Signal Supports
- TM670 - Perm. Signing Wood Post Supports Sizing Charts
- TM671 - 3 Second Gust Wind Speed Isotach
- TM675 - Extruded Aluminum Panels
- TM676 - Sign Attachments
- TM677 - Sign Mounts
- TM679 - Signal Mast Arm Street Name Sign Mounts
- TM680 - Signal Pole Mounts
- TM681, TM688 - Square Tube Sign Supports
- TM800 - Tables, Abrupt Edge And PCMS Details
- TM820 - Temporary Barricades
- TM821 - Temporary Sign Supports
- TM840 - Closure Details
- TM841 - Intersection Details
- TM842 - Signalized Intersection Details
- TM843 - Multi-Lane Signalized Intersection Details
- TM850 - 2-Lane, 2-Way Roadways

No R/W Map

NOT REVISED AS CONSTRUCTED

Ray Cranston

RAY CRANSTON, P.L.S.

DATE 11-17-10

US20 @ AIRPORT ROAD SEC. (LEBANON)		
SANTIAM HIGHWAY		
LINN COUNTY		
FEDERAL HIGHWAY ADMINISTRATION	PROJECT NUMBER	SHEET NO.
OREGON DIVISION		1A

Standard Drawings located on the web at:
http://www.oregon.gov/ODOT/HWY/ENGSERVICES/standard_drawings_home.shtml

Pavement Marking Design Guidelines

Figure D-3: Example As-Constructed Plan Sheet (3)

Contract Plans

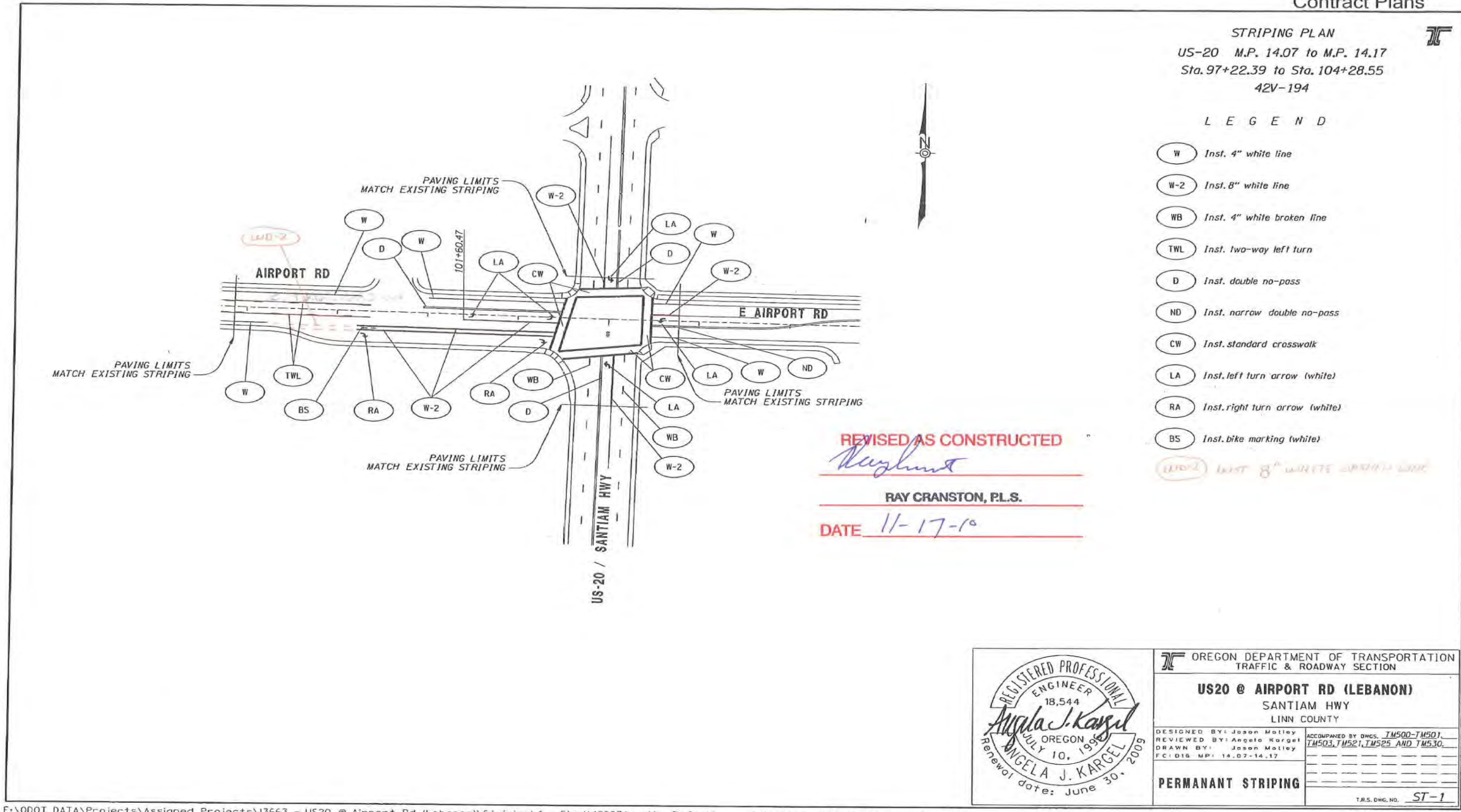

F:\ODOT_DATA\Projects\Assigned Projects\13663 - US20 @ Airport Rd (Lebanon)\Striping\4 - Final\13663tr.stl:: Default 8/14/2009 7:36:42 AM hwy90f

1:1200.BL - 001





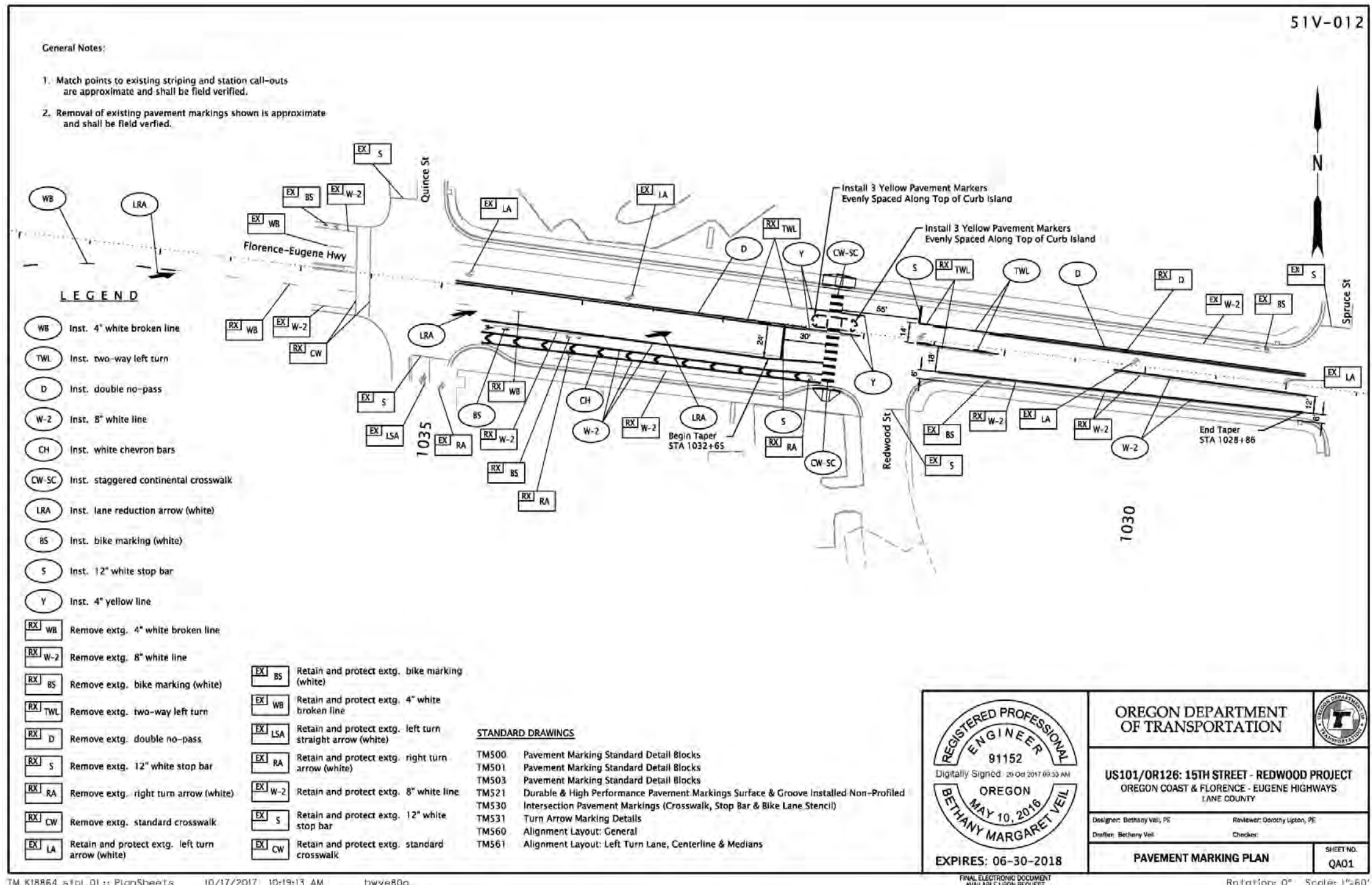





















Appendix E – Examples of Pavement Marking Plans

Figure E-1: Example Striping Plan Sheet when a Striping Details Sheet is Not Used



Pavement Marking Design Guidelines

Figure E-3: Example Striping Details Sheet

LEGEND		51V-030														
<p> Inst. narrow double yellow positioning guide</p> <p> Inst. no-pass left positioning guide</p> <p> Inst. no-pass right positioning guide</p> <p> Inst. two-way left turn positioning guide</p> <p> Inst. 4" yellow broken line supplementation</p> <p> Inst. double no-pass</p> <p> Inst. 8" white channelizing line positioning guide</p> <p> Inst. 8" white channelizing line positioning guide</p> <p> Inst. 4" white line</p> <p> Inst. 8" white line</p> <p> Inst. 8" white dotted line</p> <p> Inst. 12" white stop bar</p> <p> Inst. standard crosswalk</p> <p> Inst. staggered continental crosswalk</p> <p> Inst. left turn arrow (white)</p> <p> Inst. right turn arrow (white)</p> <p> Inst. bike marking (white)</p> <p> Inst. "SCHOOL" (white)</p> <p> Inst. "X-ING" (white)</p> <p> Inst. double no-pass positioning guide</p> <p> Inst. bike slant turn marking (white)</p> <p> Inst. 4" white dotted line</p> <p> Inst. narrow double no-pass</p>	<p> Remove extg. two-way left turn</p> <p> Remove extg. double no-pass</p> <p> Remove extg. 8" white line</p>	<p>STANDARD DRAWINGS</p> <p>TMS00 - Pavement Marking Standard Detail Blocks</p> <p>TMS01 - Pavement Marking Standard Detail Blocks</p> <p>TMS02 - Pavement Marking Standard Detail Blocks</p> <p>TMS03 - Pavement Marking Standard Detail Blocks</p> <p>TMS15 - Pavement Markers</p> <p>TMS21 - Durable & High Performance Pavement Markings Surface & Groove Installed Non-Profiled</p> <p>TMS30 - Intersection Pavement Markings (Crosswalk, Stop Bar & Bike Lane Stencil)</p> <p>TMS31 - Turn Arrow Marking Details</p> <p>TMS39 - Median and Left Turn Channelization Details</p> <p>TMS60 - Alignment Layout: General</p> <p>TMS61 - Alignment Layout: Left Turn Lane, Centerline & Medians</p> <p>TMS70 - Traffic Delineators</p> <p>TMS71 - Traffic Delineators Steel Post Details</p> <p>TMS76 - Traffic Delineator Installation For Non-Freeways</p>														
<p>General Notes:</p> <ol style="list-style-type: none"> 1. Match points to existing striping and station call-outs are approximate and shall be field verified. 2. All permanent pavement striping is Thermoplastic except as noted. See Section 00850 and 00865 in Special Provisions. 3. Contact Engineer of Record for in-depth layout details. 4. Removal of existing pavement markings shown is approximate and shall be field verified. See Section 00851 for removal information. 																
																
		<table border="1" style="width: 100%; border-collapse: collapse;"> <tr> <td colspan="2" style="text-align: center;">OREGON DEPARTMENT OF TRANSPORTATION</td> </tr> <tr> <td colspan="2" style="text-align: center;">OR99W: HOFFMAN RD. TO MONMOUTH S.C.L. SEC.</td> </tr> <tr> <td colspan="2" style="text-align: center;">PACIFIC HIGHWAY WEST POLK COUNTY</td> </tr> <tr> <td style="width: 50%;">Designer: Bethany Veil, PE</td> <td style="width: 50%;">Reviewer: Dorothy Upton, PE</td> </tr> <tr> <td>Drafter: Bethany Veil</td> <td>Checker: Ian Rohoff, PE</td> </tr> <tr> <td colspan="2" style="text-align: center;">PAVEMENT MARKING PLAN</td> </tr> <tr> <td colspan="2" style="text-align: right;">SHEET NO. QA01</td> </tr> </table>	OREGON DEPARTMENT OF TRANSPORTATION		OR99W: HOFFMAN RD. TO MONMOUTH S.C.L. SEC.		PACIFIC HIGHWAY WEST POLK COUNTY		Designer: Bethany Veil, PE	Reviewer: Dorothy Upton, PE	Drafter: Bethany Veil	Checker: Ian Rohoff, PE	PAVEMENT MARKING PLAN		SHEET NO. QA01	
OREGON DEPARTMENT OF TRANSPORTATION																
OR99W: HOFFMAN RD. TO MONMOUTH S.C.L. SEC.																
PACIFIC HIGHWAY WEST POLK COUNTY																
Designer: Bethany Veil, PE	Reviewer: Dorothy Upton, PE															
Drafter: Bethany Veil	Checker: Ian Rohoff, PE															
PAVEMENT MARKING PLAN																
SHEET NO. QA01																

Pavement Marking Design Guidelines

Figure E-4: Example Striping Plan Sheet When a Striping Details Sheet is Used (1)

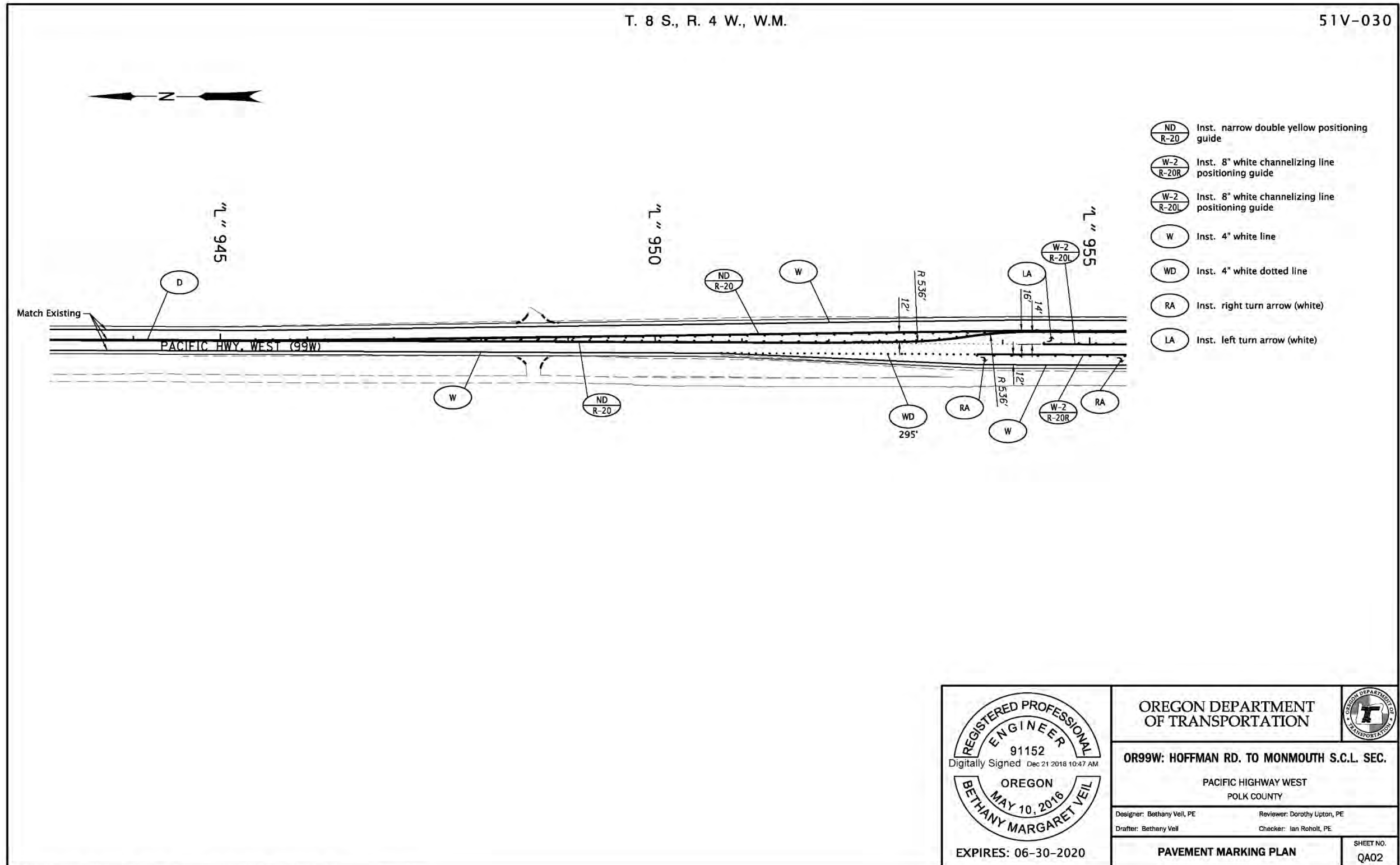

<p>REGISTERED PROFESSIONAL ENGINEER 91152 Digitally Signed Dec 21 2018 10:47 AM OREGON MAY 10, 2016 BETHANY MARGARET VEIL EXPIRES: 06-30-2020</p>	<p>OREGON DEPARTMENT OF TRANSPORTATION</p>
	<p>OR99W: HOFFMAN RD. TO MONMOUTH S.C.L. SEC.</p> <p>PACIFIC HIGHWAY WEST POLK COUNTY</p>
<p>Designer: Bethany Veil, PE Reviewer: Dorothy Upton, PE Drafter: Bethany Veil Checker: Ian Roholt, PE</p>	<p>PAVEMENT MARKING PLAN</p> <p>SHEET NO. QA02</p>

TM_K19132_pmpl_01.dgn :: Sheets 12/21/2018 10:36:26 AM hwyr20b

FINAL ELECTRONIC DOCUMENT AVAILABLE UPON REQUEST

Rotation: 0° Scale: 1"=100'

Pavement Marking Design Guidelines

Figure E-5: Example Striping Plan Sheet When a Striping Details Sheet is Used (2)

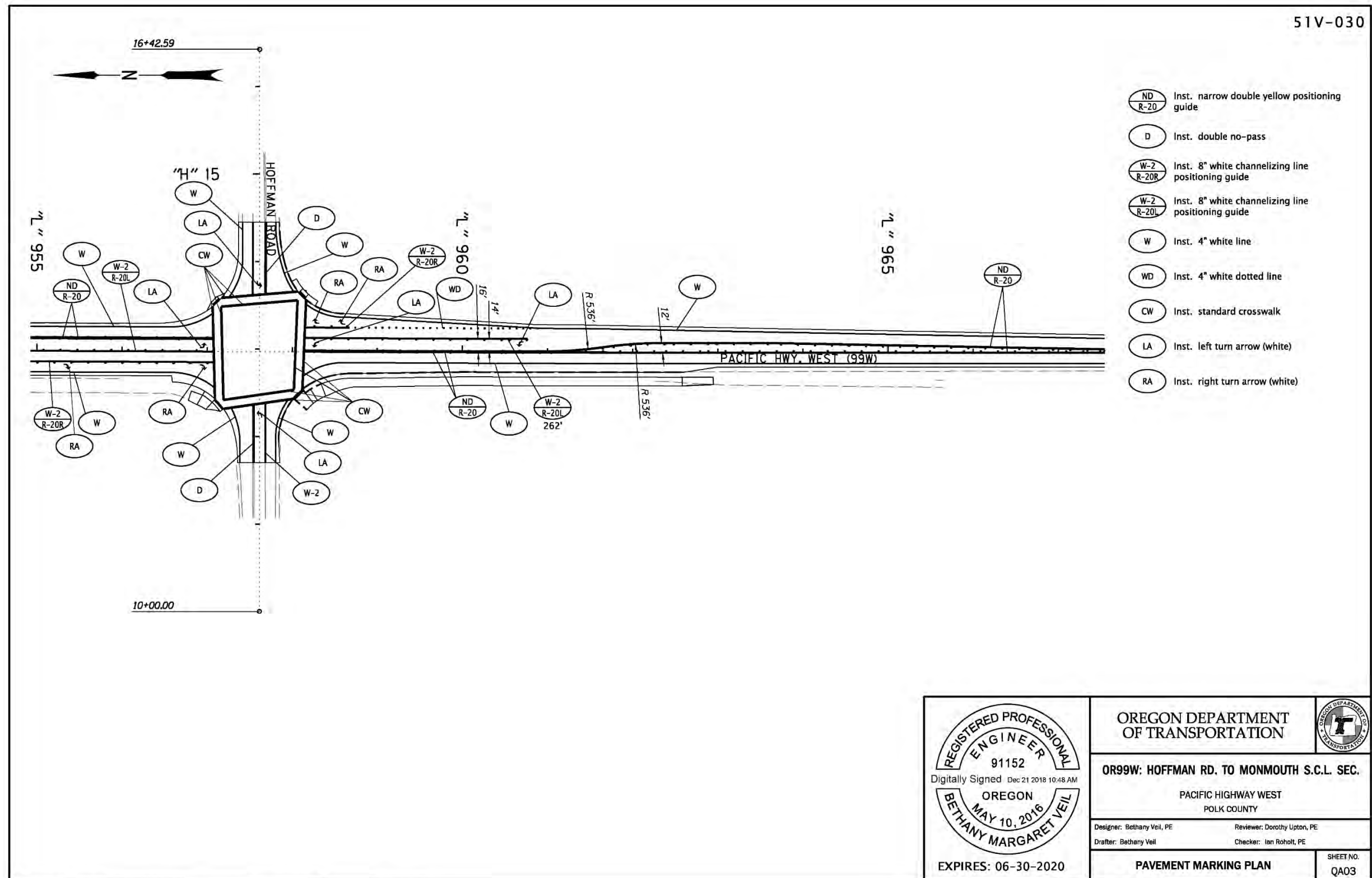

<p>REGISTERED PROFESSIONAL ENGINEER 91152 Digitally Signed Dec 21 2018 10:48 AM OREGON MAY 10, 2016 BETHANY MARGARET VEIL EXPIRES: 06-30-2020</p>	<p>OREGON DEPARTMENT OF TRANSPORTATION</p>	
	<p>OR99W: HOFFMAN RD. TO MONMOUTH S.C.L. SEC.</p>	
	<p>PACIFIC HIGHWAY WEST POLK COUNTY</p>	
	<p>Designer: Bethany Veil, PE Drafter: Bethany Veil</p>	<p>Reviewer: Dorothy Upton, PE Checker: Ian Roholt, PE</p>
<p>PAVEMENT MARKING PLAN</p>		<p>SHEET NO. QA03</p>

TM_K19132_pmpl_01.dgn :: Sheets 12/21/2018 10:37:52 AM hwyr20b

FINAL ELECTRONIC DOCUMENT AVAILABLE UPON REQUEST

Rotation: 0° Scale: 1"=100'