



Oregon Department of Transportation



*RW
Engineering*

OREGON DEPARTMENT OF
TRANSPORTATION
RIGHT OF WAY ENGINEERING TRAINING

ACCESS RIGHTS

A RIGHT OF WAY ENGINEERING PERSPECTIVE

RIGHT OF WAY ENGINEERING GROUP
ENGINEERING AUTOMATION SECTION
GEOMETRONICS UNIT
SEPTEMBER, 2019



ACCESS RIGHTS

ODOT has the authority to control and regulate access to all of Oregon's highways. This authority can come from ODOT's acquisition of property rights from the abutting owners, from the effect of State laws, or from police powers through the permitting process.

Private property that adjoins a highway has a common-law abutter's right to access to the highway. This is a property right that can be conveyed. ODOT can acquire the access rights to completely prohibit access to the highway or to set conditions on where and how highway access will be allowed by ODOT.

This conveyance is recorded in the deed records of the local County. The limited access rights would show as an encumbrance on a title report for the property.

In certain situations, State laws supersede the common-law rights and preclude the adjoining property owner from accessing the highway. ORS 374.405 states that property owners do not have abutters rights of access to a new state highway alignment. The lone effect of this legislation would probably not be revealed on a title report for the property.



ACCESS RIGHTS

The laws and regulations that govern the establishment and operation of state highways are found in the following Oregon Revised Statutes and Administrative Rules:

- ORS Chapter 366 – State Highways and State Highway Fund
- ORS Chapter 374 - Control of Access to Public Highways
- OAR Division 51 - Highway Approaches, Access Control, Spacing Standards and Medians



ACCESS RIGHTS

Oregon Administrative Rules



ACCESS RIGHTS

734-051-0020 Purpose and Applicability of Rules

The purpose of division 51 rules is to provide a safe and efficient transportation system through the ... protection of highway traffic from the hazards of unrestricted and unregulated entry from adjacent property... These rules establish procedures and criteria used by the Department to govern highway approaches, access control, spacing standards, medians and restriction of turning movements...

734-051-1070 – Definitions

(1) "Access Control" means no right of access exists between a property abutting the highway and the highway.

The right of access may have been acquired by the Department or eliminated by law.

(4) "Alternate Access" means the physical existence of other means to access a property than the proposed approach, such as an existing public right of way, another location on the subject state highway, an easement across adjoining property, a different highway, a service road, or an alley...

(9) "Approach" means a legally constructed, approach road or private road crossing, recognized by the Department as grandfathered or existing under a valid Permit to Operate.

(30) "Grandfathered approach" means a legally constructed approach existing prior to 1949. A property owner has the burden to prove an approach is grandfathered based upon existence prior to 1949...



ACCESS RIGHTS

734-051-1070 – Definitions

(31) "Grant of Access" means the conveyance or evidence of the conveyance from the Department of a specific right of access at a location where an abutting property currently does not have that specific right of access.

(35) "Indenture of Access" means a deeded conveyance that changes the location, width, or use restrictions of an existing reservation of access.

(65) "Reservation of Access" means a limitation of a common law right of access to a specific location where the Department has acquired access control subject to restrictions that are designated in a deed. A reservation of access may include a use restriction limiting the right of access to a specified use or restriction against a specified use...

A reservation of access affords the right to apply for an approach but does not guarantee approval of an Application for State Highway Approach or the location of an approach.

(66) "Right of access" means the right of ingress and egress to the roadway and includes a common law right of access, reservation of access, or grant of access.

(67) "Right of way" means real property or an interest in real property owned by the Department as defined in the 1999 Oregon Highway Plan.



ACCESS RIGHTS

Oregon Revised Statutes



ACCESS RIGHTS

366.205 Power and authority of commission over highways; rules.

(1) The Oregon Transportation Commission has general supervision and control over all matters pertaining to the selection, establishment, location, construction, improvement, maintenance, operation and administration of state highways... and all other matters and things considered necessary or proper by the commission for the accomplishment of the purposes of this Act.

366.320 Acquisition of rights of way and right of access.

(2) The department may acquire by purchase, agreement, donation or by the exercise of the power of eminent domain, real property or any right or interest therein deemed necessary for rights of way, either for original location or for widening, straightening or otherwise changing any highway, road or street.

The department may, when acquiring real property for right of way, acquire all right of access from abutting property to the highway to be constructed, relocated or widened.

366.340 Acquisition of real property generally.

The Department of Transportation may acquire by purchase, agreement, donation or by exercise of the power of eminent domain real property, or any right or interest therein, including any easement or right of access, deemed necessary for:

(5) Elimination or prevention of hazardous or undesirable points of entry from adjacent property to state highways.



ACCESS RIGHTS

“Throughways”



ACCESS RIGHTS

The Throughway system was authorized by the Oregon Legislature in 1947, and enacted by the Oregon Transportation Commission November 3, 1948 in Resolution No. 5. This system, as originally conceived was to provide a continuing method of protecting the integrity of the highway system and to provide for a safer and more viable highway system.

As defined, a “Throughway” is a highway or street designed for through traffic, from which abutting properties have no or only a limited easement of access.

Starting in 1948, the OTC designated certain highways in the state as Throughways. Each of these highways was then surveyed for the location of commercial businesses along the route. If in any given one mile segment of the highway there were 10 or more commercial businesses, then that portion of the highway was excepted as a Throughway.

The Throughway system, with excepted and non-excepted portions, is indexed through several levels of mapping.



ACCESS RIGHTS

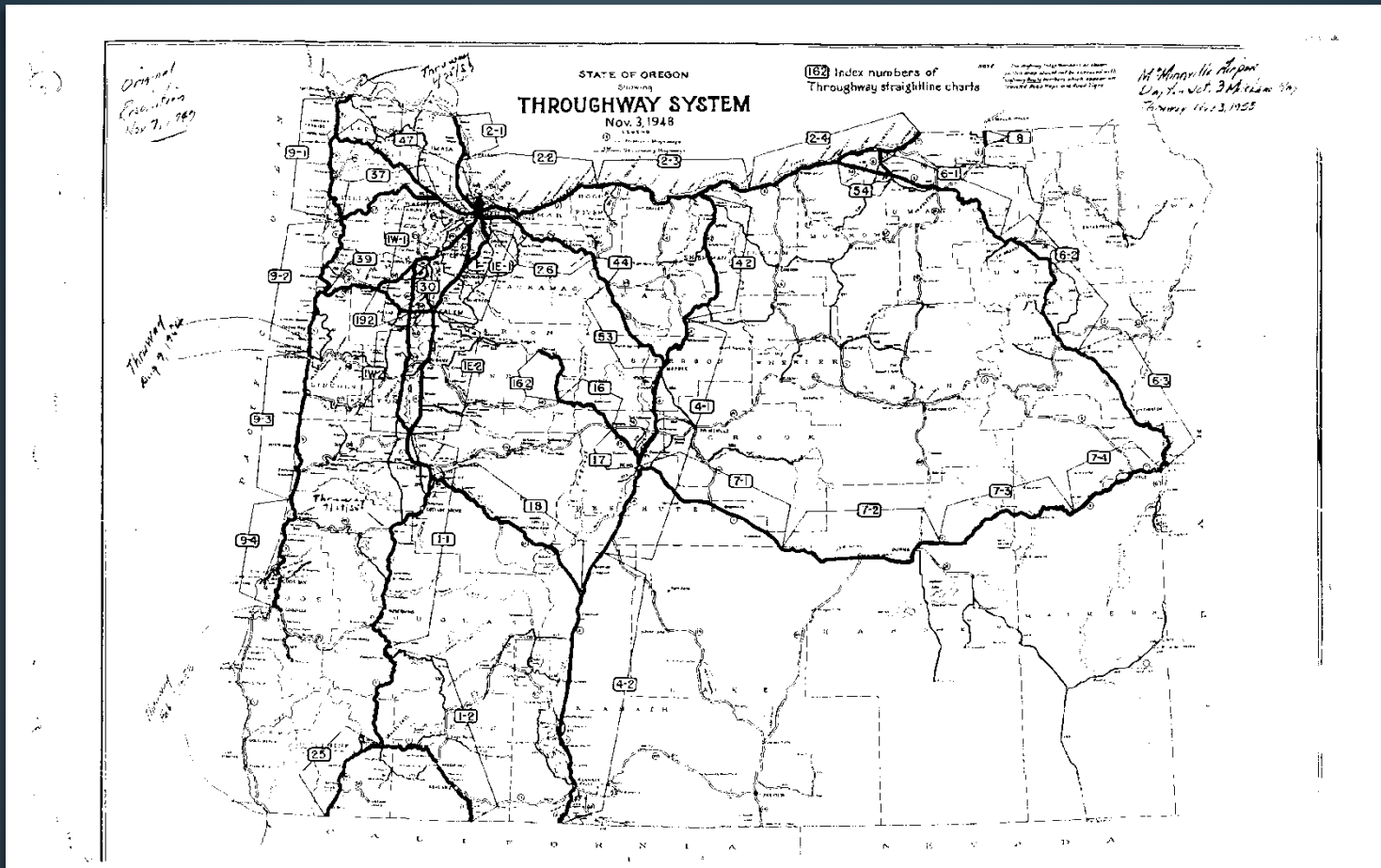



ACCESS RIGHTS

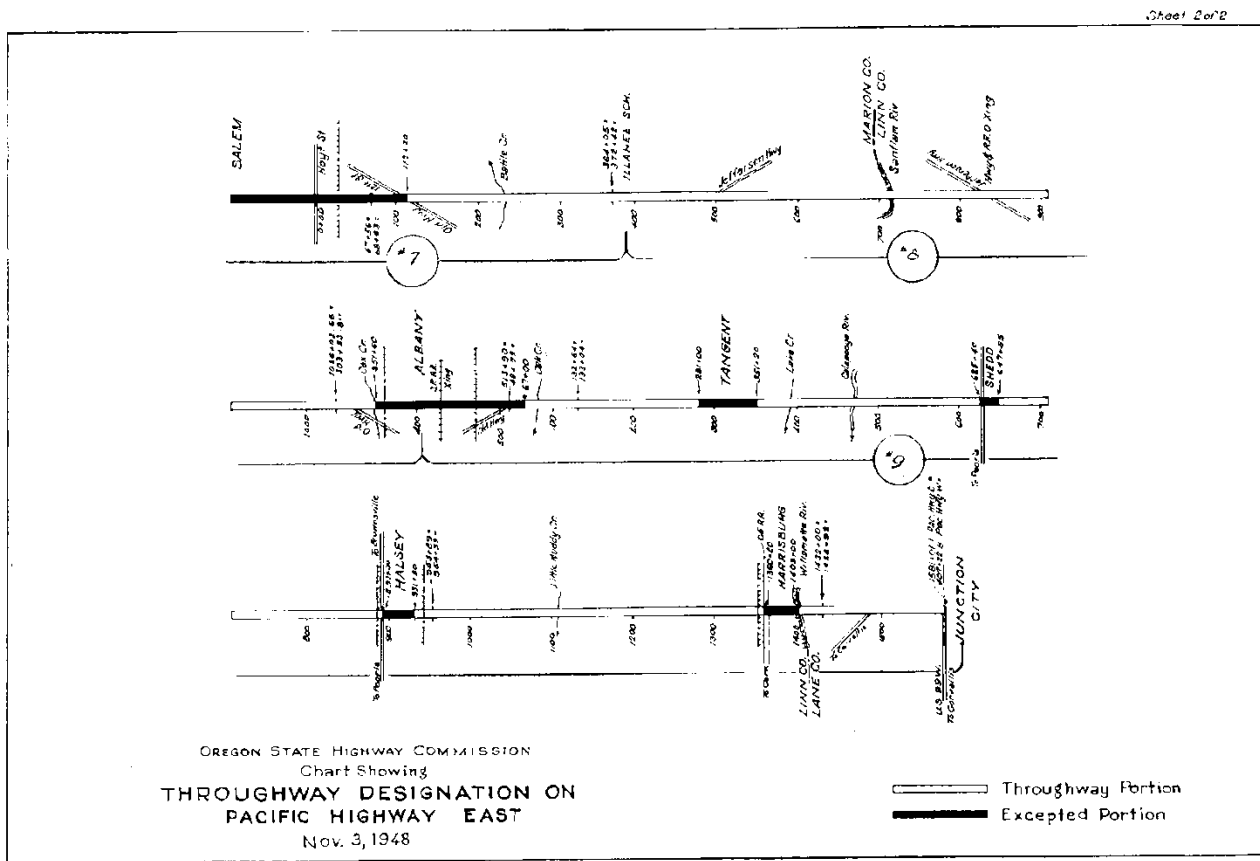

1F-2



ACCESS RIGHTS

374.010 “Throughway” defined.

As used in ORS 374.005 to 374.095, “throughway” means a highway or street especially designed for through traffic, over, from or to which owners or occupants of abutting land or other persons have no easement of access or only a limited easement of access, light, air or view, by reason of the fact that their property abuts upon the throughway or for any other reason.

374.015 Department of Transportation to establish and maintain throughways; highways to be designated throughways.

(2) Any relocated section of an existing highway and such portions of existing highways, which at the time they are designated as throughways have less than 10 commercial businesses abutting thereon catering to the motoring public in any one mile of such existing highway, may be designated and constructed as or converted into a throughway by the department...

374.035 Acquisition of real property; effect of resolution.

(1) The Department of Transportation may...acquire by agreement, donation or exercise of the power of eminent domain, fee title to or any interest in any real property, including easements of air, view, light and access, which in the opinion or judgment of the department is deemed necessary for the construction of any throughway...



ACCESS RIGHTS

374.085 Severance by throughway of agricultural land.

Wherever by the location, relocation, establishment and construction or reconstruction of a throughway under ORS 374.005 to 374.095 real property, title to which is held under one ownership, is severed and the land is being used for farm or other agricultural purposes, provision shall be made by the Department of Transportation for crossing the highway from one such tract to the other or compensation for the severance of the tract shall be paid.

374.090 Destruction by throughway of access to agricultural property.

Whenever a throughway is located, relocated, constructed or reconstructed through or over farm or agricultural property and thereby all reasonable ingress and egress have been destroyed, the Department of Transportation shall provide access from the abutting properties to the throughway by a service road or by direct access, unless by agreement with the owners of the abutting properties access to the throughway has been waived by the property owner or has been acquired by the state by agreement or exercise of the power of eminent domain.



ACCESS RIGHTS

374.095 Utility roads where access to abutting property affected.

If under ORS 374.005 to 374.095 any existing highway or section of existing highway is converted into a throughway, by reason thereof real properties then occupied and used are affected and such abutting real properties are dependent upon the existing highway or section of highway for ingress and egress, the Department of Transportation shall provide a utility or service road to serve the properties...

374.310 State permits; rules.

(1)The Department of Transportation...shall adopt reasonable rules and regulations and may issue permits... for the use of the rights of way of such highways and roads for the purposes described in ORS 374.305. However, the department may not issue a permit for the construction of any approach road at a location where no rights of access exist between the highway and abutting real property.

(3)The powers granted by this section and ORS 374.315 may not be exercised so as to deny any property adjoining the road or highway reasonable access...



ACCESS RIGHTS

No Abutters Rights of Access
The “1951 Law”



ACCESS RIGHTS

374.405 Access rights of property abutting on state highways.

No rights in or to any state highway, including what is known as right of access, shall accrue to any real property abutting upon any portion of any state highway constructed, relocated or reconstructed after May 12, 1951, upon right of way, no part of the width of which was acquired prior to May 12, 1951, for public use as a highway, by reason of the real property abutting upon the state highway.

374.410 Department of Transportation to prescribe access rights of abutting property.

In connection with any acquisition of real property for right of way of any state highway, the Department of Transportation shall prescribe and define the location, width, nature and extent of any right of access that may be permitted by the department to pertain to real property described in ORS 374.405.



ACCESS RIGHTS

Abutting property owners have no rights of access to a new highway alignment route

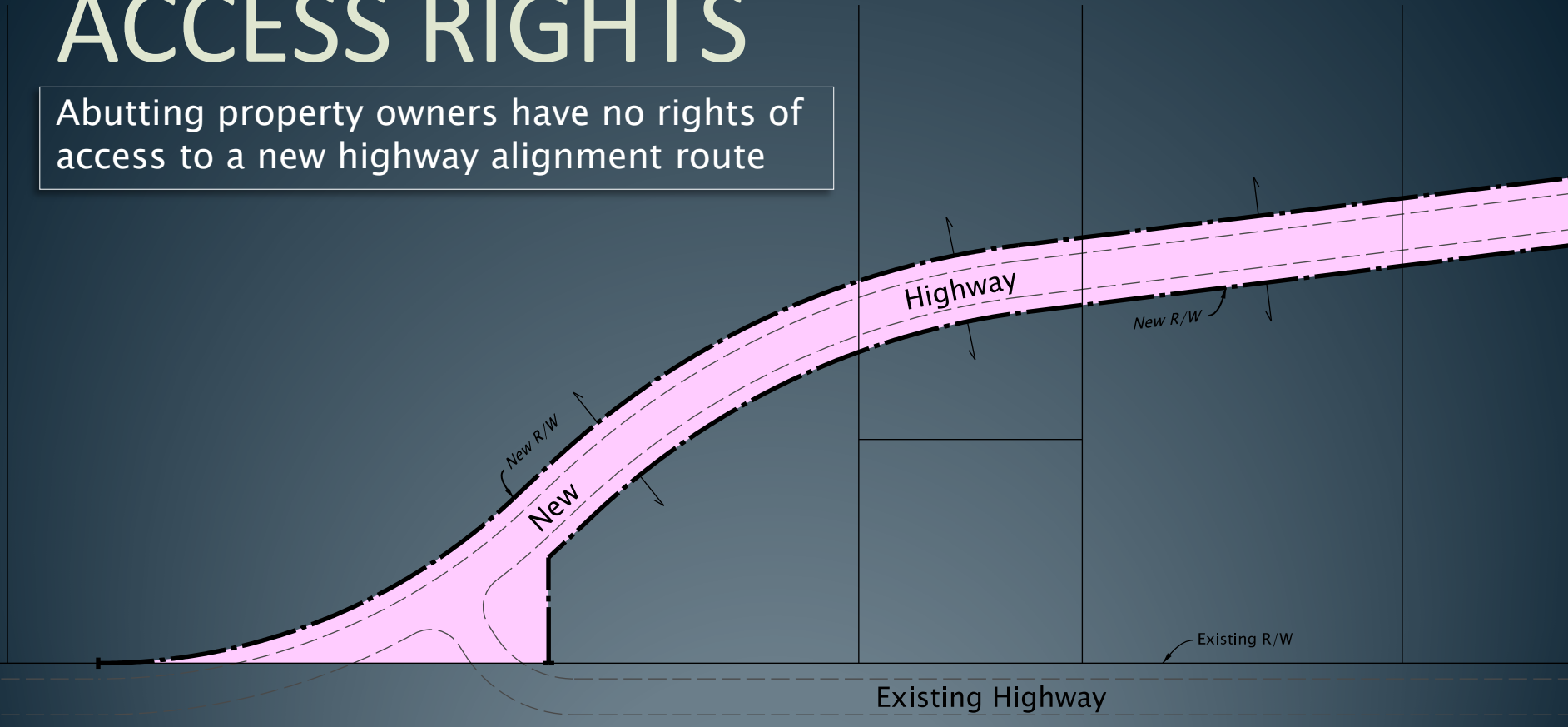



ACCESS RIGHTS

Regardless of a property owner's common-law rights, an adjoining property owner must always obtain a permit from ODOT to access the highway. In addition to ODOT's acquisition of any property rights or the effect of State laws, the regulatory permitting power gives ODOT full authority to manage and control all highway access.

The type of access rights, if any, that are to be acquired are identified and noted in the addenda information for the acquisition file. Key phrases are used that tells the Document Specialist the specific access language to put in the deed for each parcel of the description.

Access rights are a covenant that remains with the Grantor's property.

i.e. what access right do we purchase from the Grantor: All abutters rights, controlled rights. This now becomes a covenant attached to the remaining property.



- None
- Restricted to Highway
- Controlled to Highway
- Restricted to Parcel
- Controlled to Parcel
- Uncontrolled to Frontage Road
- Controlled to Frontage Road
- Restricted to Frontage Road
- Controlled to Highway With Future Frontage Road
- ORS 374.405 – No abutter's rights of access (Complete Restriction To Highway)
- ORS 374.405 – No abutter's rights of access (With Reservation Of Access Granted)
- Joint Access
- Farm Access
- Farm Crossing
- Undercrossing



FIRST ST.

SECOND ST.

Access Control: None
No access control language stated in deed. Taking is shown with solid line style.

001

STATE HIGHWAY (MAIN ST.)



R/W File Addendum note

“Access Key Phrase”: NONE

Deed Language

No specific access language in deed.

Application

All existing access rights, if any, between the grantor’s remaining real property and the highway will remain. If ODOT has never purchased any access rights from this property, then highway access will continue to be regulated solely by ODOT’s permit process.



Access Control: Restricted to Highway
Access is restricted to the highway.
Alternative access exists on the City streets. The access rights taken apply to entire frontage of the highway.

FIRST ST.

SECOND ST.



Access Only

001

002

STATE HIGHWAY (MAIN ST.)



The access rights that are taken may be incorporated with a fee taking parcel or it may be a separate "Access Only" parcel.

FIRST ST.

SECOND ST.

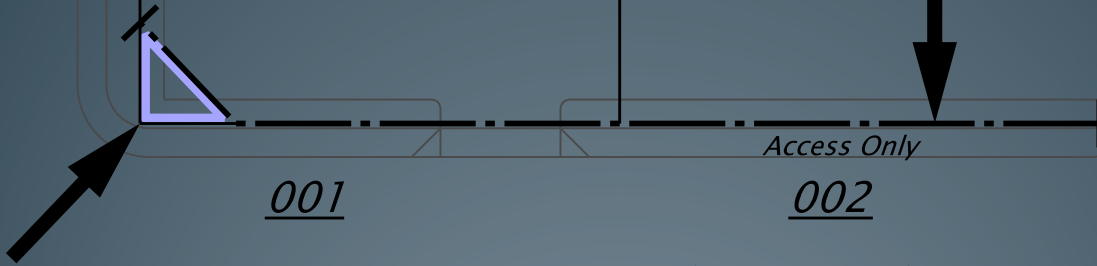

STATE HIGHWAY (MAIN ST.)



R/W File Addendum note

“Access Key Phrase”: RESTRICTED TO HIGHWAY (Highway Name)

Deed Language

TOGETHER WITH all abutter's rights of access between the *Highway Name* Highway and Grantor's remaining real property.

Application

No access reservations are identified. Access between the grantor's remaining property and the highway is completely prohibited; the grantor's property can only be accessed from another public road or street. This is the method for eliminating all access rights between the grantor's property and the highway, when the parcel does not span the full frontage of the property.



Access Control: Controlled to Highway
No alternative access to properties exists, reservation of access is granted in the deeds.

FIRST ST.

SECOND ST.

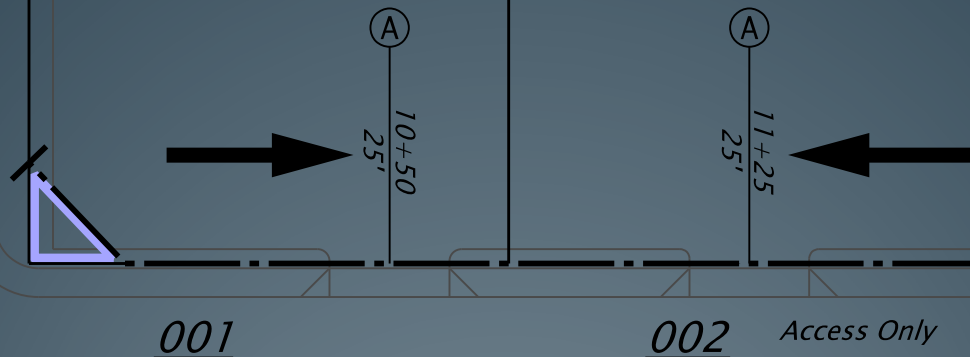

STATE HIGHWAY (MAIN ST.)



R/W File Addendum note

“Access Key Phrase”: CONTROLLED TO HIGHWAY (*Highway Name*)

Deed Language

TOGETHER WITH ALL abutter's rights of access between the (*Highway Name*) Highway and Grantor's remaining real property, EXCEPT, however,

Reserving access rights, for the service of Grantor's remaining property, to and from said remaining property to the abutting highway at the following place(s), in the following width(s):

Hwy. Engr's Sta.	Side of Hwy.	Width
------------------	--------------	-------

Application

All access rights between the highway and grantor's remaining property, with reservation(s) of access. Project team to provide the reservation station(s), which side of the highway and the width of the reservation(s).



Access Control: Restricted to Parcel
Access restricted to parcel. Alternative
access exists on City street.

FIRST ST.

SECOND ST.

001

STATE HIGHWAY (MAIN ST.)



R/W File Addendum note

“Access Key Phrase”: RESTRICTED TO PARCEL. (Parcel #)

Deed Language

TOGETHER WITH all abutter's rights of access between the above-described parcel and Grantor's remaining real property.

Application

No access reservations are identified. Access between the grantor's remaining property and the parcel is completely prohibited. All existing access rights, if any, that are not via the parcel will remain. This is the method for eliminating only the access rights through the parcel, when the parcel does not span the full frontage of the property. This is the preferred method for eliminating all access rights between the grantor's property and the highway, when the parcel spans the full frontage of the property.



Access Control: Controlled to Parcel
No alternative access exists,
reservation of access is granted in
deed.

FIRST ST.

SECOND ST.

Ⓐ
10+50
25'

001

STATE HIGHWAY (MAIN ST.)



R/W File Addendum note

“Access Key Phrase”: CONTROLLED TO PARCEL.”

Deed Language

TOGETHER WITH ALL abutter's rights of access between the above-described parcel and Grantor's remaining real property, EXCEPT, however,

Reserving access rights, for the service of Grantor's remaining property, to and from said remaining property to the abutting highway at the following place(s), in the following width(s):

Hwy. Engr's Sta.	Side of Hwy.	Width
------------------	--------------	-------

Application

All rights between the described parcel and grantor's remaining property, with reservation(s) of access. Project team to provide the reservation station(s), which side of the highway and the width of the reservation(s).



Access to a frontage road is addressed as with access to the highway; it can be restricted, controlled or uncontrolled. The access language notes for frontage roads to be entered into the addenda information for the acquisition are:

- Uncontrolled To Frontage Road
- Controlled To Frontage Road
- Restricted To Frontage Road

These parcel access notes are to be used in conjunction with a note for the highway when we have a frontage road, either restricting access to the highway or controlling it to the highway. Any access reservations to the highway itself will be at points other than on the frontage road.



ACCESS RIGHTS

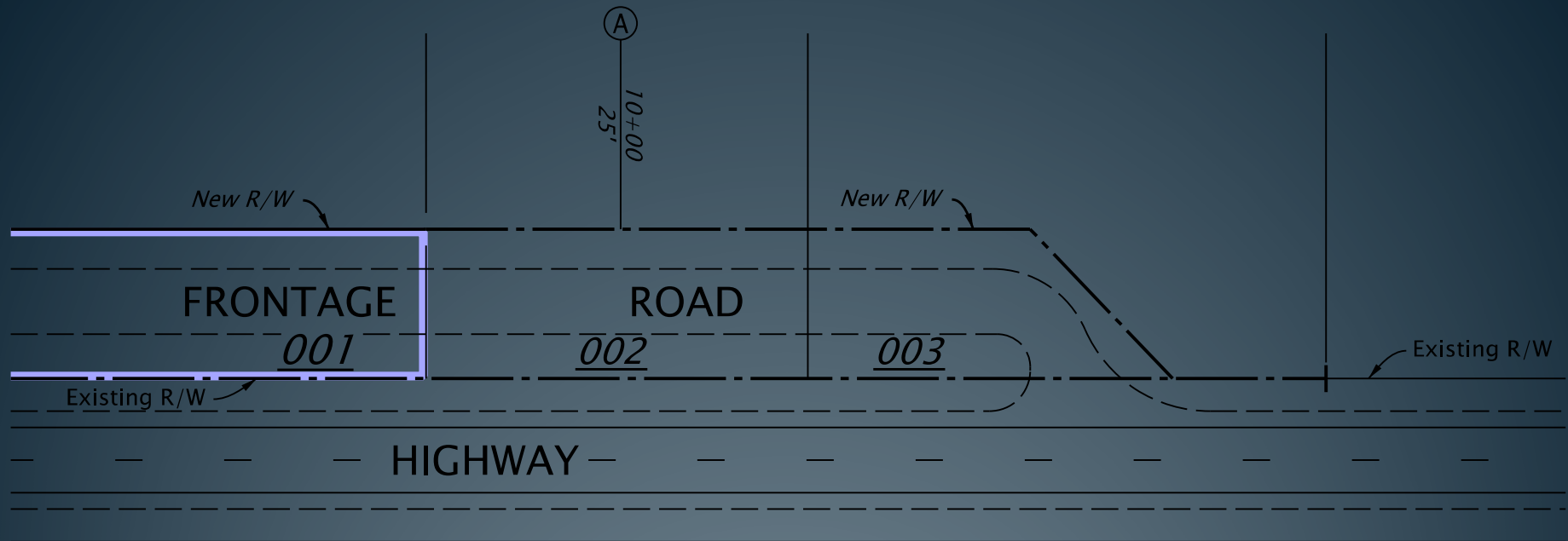

Access Control: Restricted to Highway
Uncontrolled to Frontage Road

All access rights between the highway and Grantor's remaining property with access uncontrolled to a public frontage road to be built during the project or some other public access road.



R/W File Addendum note

“Access Key Phrase”: RESTRICTED TO HIGHWAY (*Highway Name*)
UNCONTROLLED TO FRONTAGE ROAD

Deed Language

TOGETHER WITH all abutter's rights of access between the (*Highway Name*) Highway and Grantor's remaining real property, EXCEPT, however,

Grantee shall either construct a public frontage road, or provide some other access road on the _____ side of the highway, and Grantor and Grantor's heirs, successors and assigns, shall be entitled to access to said road for any purpose upon application filed with Grantee and issuance of a road approach permit pursuant to applicable statutes and regulations. Said road shall be connected to the main highway or to other public ways only at such places as Grantee may select.

Application

No access reservations are identified. Direct access between the grantor's remaining property and the highway is completely prohibited; the grantor's property can only be accessed from the frontage road or another public road.



ACCESS RIGHTS

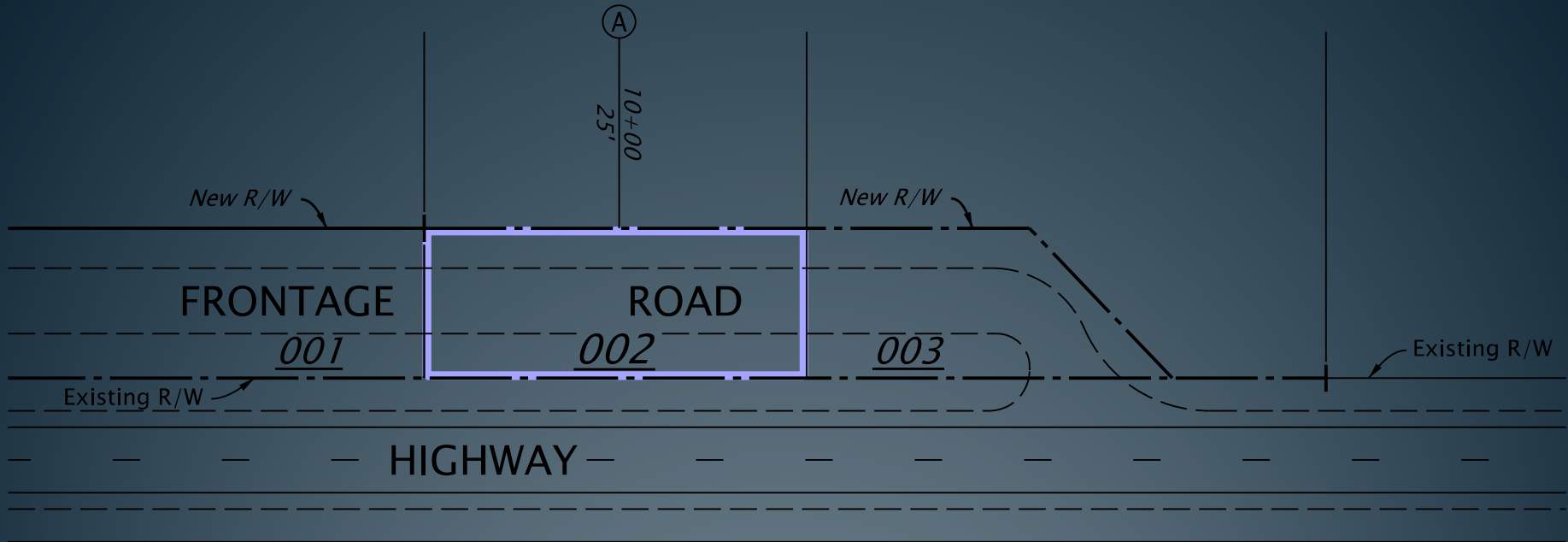

Access Control: Restricted to Highway
Controlled to Frontage Road

Access to highway allowed only via a public frontage road. Reservation of access granted to frontage road.



R/W File Addendum note

“Access Key Phrase”: RESTRICTED TO HIGHWAY (*Highway Name*)
CONTROLLED TO FRONTAGE ROAD

Deed Language

TOGETHER WITH all abutter's rights of access, if any, between the Highway Name Highway and Grantor’s remaining real property.

ALSO TOGETHER WITH all abutter's rights of access, if any, between the Frontage Road and Grantor’s remaining real property, EXCEPT, however,

Reserving access rights for the service of Grantor's remaining property, to and from said remaining property to a public frontage road or other public access road, which Grantee shall construct, at the following place(s), in the following width(s):

Hwy. Engr's Sta.	Side of Hwy.	Width
------------------	--------------	-------

Said road shall be connected to the main highway or to other public ways only at such places as Grantee may select.

Application

All access rights between the highway and Grantor’s remaining property with access controlled to a public frontage road or some other public access road to be built during the project. Project team to provide the reservation station(s), which side of the highway and the width of the reservation(s).



ACCESS RIGHTS

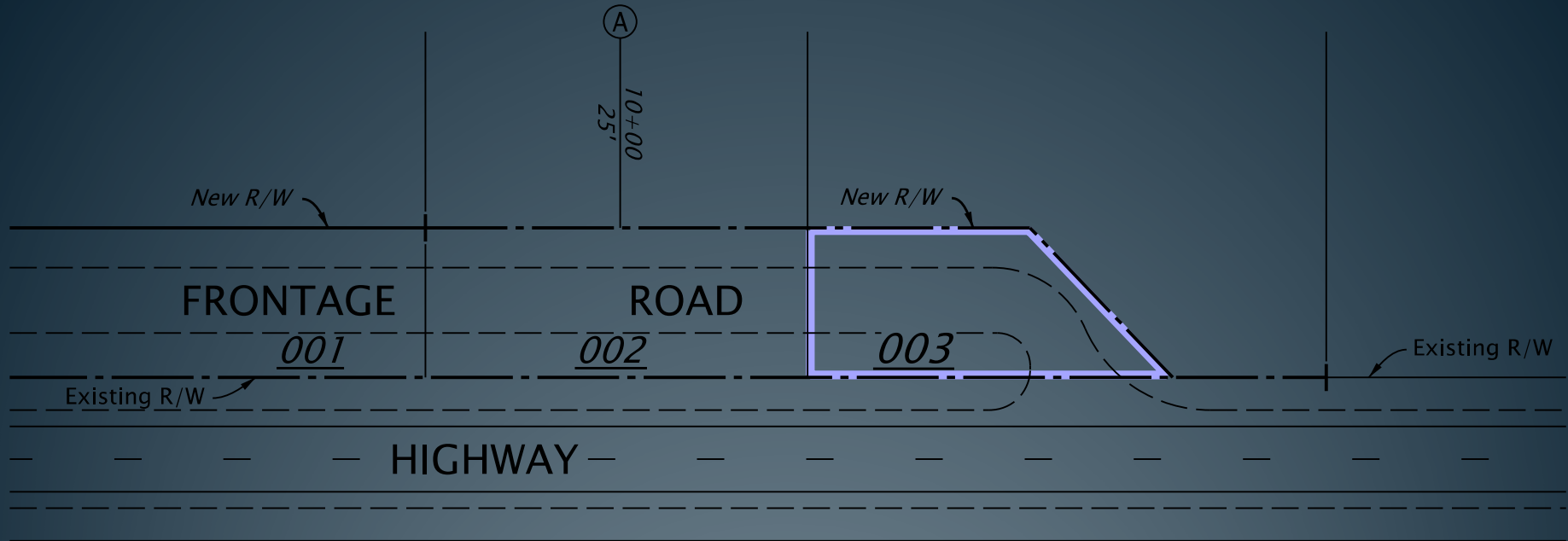

Access Control: Restricted to Highway
Restricted to Frontage Road

Access to highway and frontage road is completely restricted.



R/W File Addendum note

“Access Key Phrase”: RESTRICTED TO HIGHWAY (*Highway Name*)
RESTRICTED TO FRONTAGE ROAD”

Deed Language

TOGETHER WITH all abutter's rights of access between the (*Highway Name*) Highway and constructed public frontage road or other public access road and Grantor's remaining real property.

Application

All access rights between the highway including the constructed public frontage road or other public access road and grantor's remaining property.



ACCESS RIGHTS

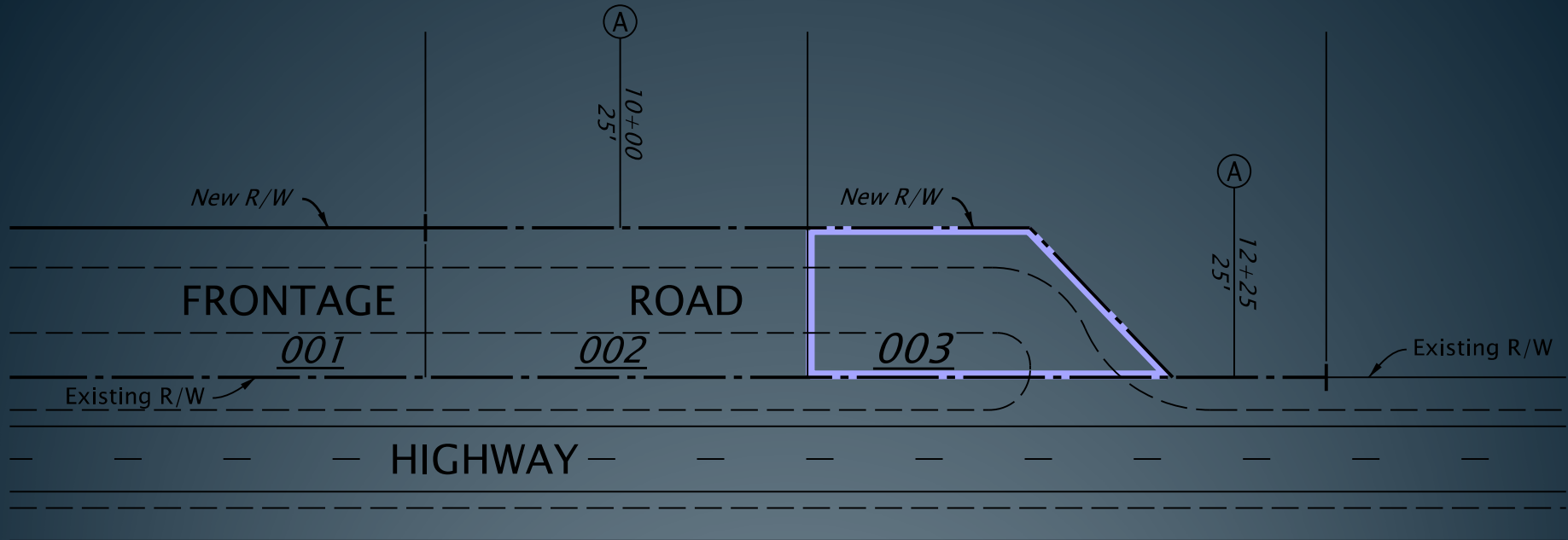

Access Control: Controlled to Highway
Restricted to Frontage Road

Access to frontage road is completely restricted and reservation provided to the highway.



R/W File Addendum note

“Access Key Phrase”: Controlled to Highway (*Name of Highway*)
Restricted to Frontage Road.”

Deed Language

TOGETHER WITH all abutter's rights of access between the *Name of Highway* and constructed public frontage road or other public access road and Grantor's remaining real property, EXCEPT, however,

Reserving access rights, for the service of Grantor's remaining property, to and from said remaining property to the abutting highway at the following place(s), in the following width(s):

Hwy. Engr's Sta.	Side of Hwy.	Width
------------------	--------------	-------

Application

All access rights between the highway and public frontage road or some other public access road and Grantor's remaining property with reservation(s) of access to the highway. Project team to provide the reservation station(s), which side of the highway and the width of the reservation(s).



R/W File Addendum note

“Access Key Phrase”: CONTROLLED TO HIGHWAY WITH FUTURE FRONTAGE ROAD”

Deed Language

TOGETHER WITH all abutter's rights of access between the (*Highway Name*) Highway and Grantor’s remaining real property, EXCEPT, however,

Reserving access rights, for the service of Grantor’s remaining property, to and from said remaining property to the abutting highway at the following place(s), in the following width(s):

Hwy. Engr's Sta.	Side of Hwy.	Width
------------------	--------------	-------

Grantee has the right to construct or otherwise provide at any future time a public frontage road or roads, or some other access road; whereupon all rights of access herein above reserved to and from the highway shall cease, but the Grantor and grantor’s heirs, successors and assigns, shall have access to the frontage road or roads, or other public access road for any purpose upon obtaining a permit from the State under the applicable statutes and regulations governing the same. Said road or roads shall be connected to the main highway or to other public ways only at such places as the Grantee may select.



ACCESS RIGHTS

Application

Grantee has the right to construct a future frontage road or other public access road at which time all reservations to the highway shall extinguish and grantor will be granted a reservation(s) to the constructed frontage road or public access road. Project team to provide the reservation station(s), which side of the highway and the width of the reservation(s).



Access Control: Joint Access

Property "A" and property "B" share a common driveway and no alternative access exists. Reservation is granted serving both properties

FIRST ST.

SECOND ST.

A

B



Access Only

Access Only

001

002

STATE HIGHWAY (MAIN ST.)



R/W File Addendum note

“Access Key Phrase”: CONTROLLED TO HIGHWAY (*Highway Name*)
WITH JOINT ACCESS”

Deed Language

TOGETHER WITH all abutter's rights of access between the (*Highway Name*) Highway and Grantor's remaining real property, EXCEPT, however,

Reserving access rights, for the service of Grantor's remaining property, to and from said remaining property to the abutting highway at the following place(s), in the following width(s):

Hwy. Engr's Sta.	Side of Hwy.	Width
------------------	--------------	-------

It is specifically understood that the access rights opposite Highway Engineer's Station (*Engineer's Station*) are to be used and enjoyed in common with the adjoining property owners on the (*Direction*), who currently is/are *Name of adjoining property owners* (File #).

Application

The R/W agent is expected to provide the width and Engineer's Station for any new access reservation. At least one of the access reservations will be shared in common with the adjoining neighbor. Joint-use reservations normally straddle the property line between the neighbors.



ACCESS RIGHTS

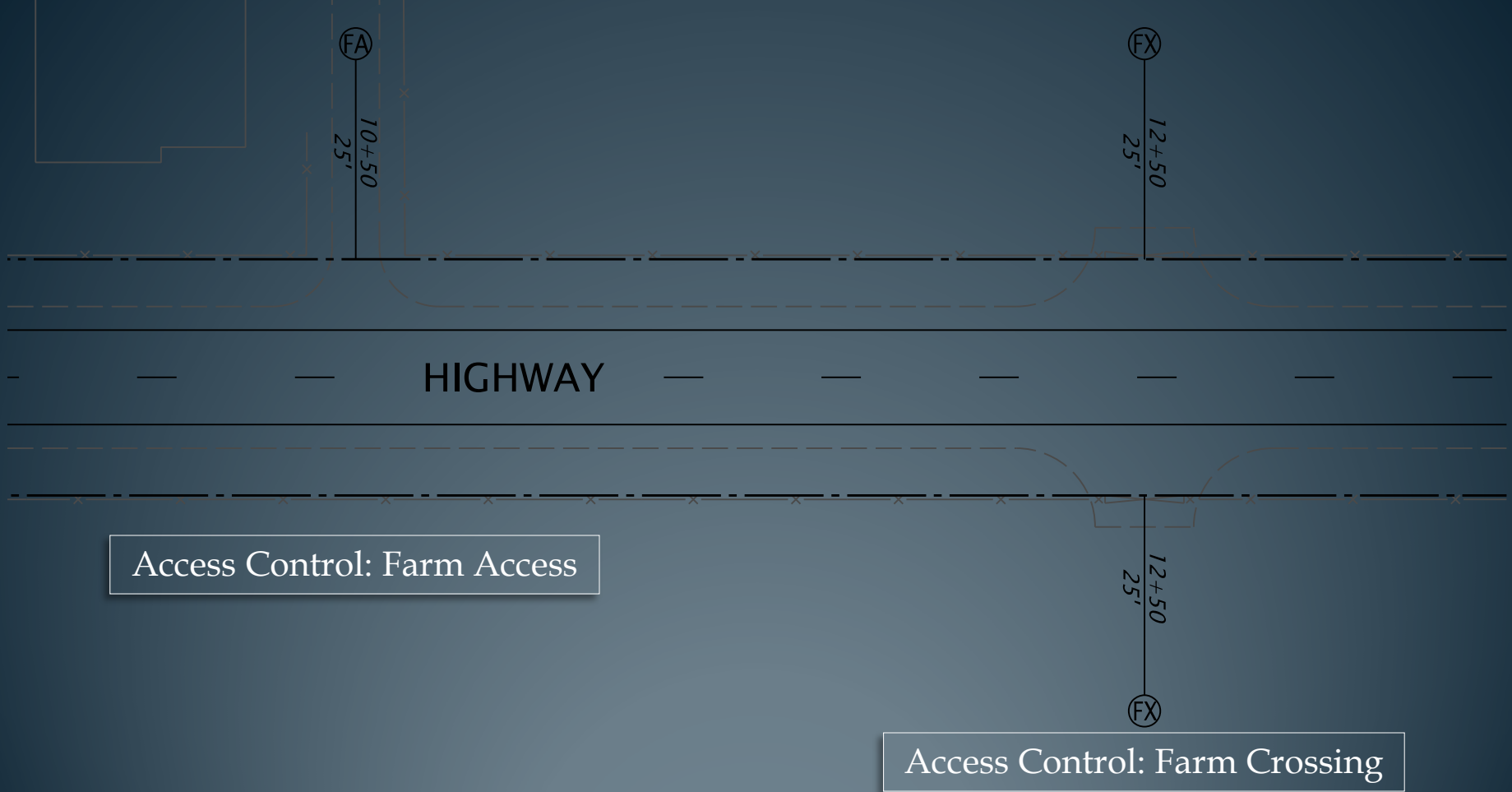



R/W File Addendum notes

“Access Key Phrase”: CONTROLLED TO HIGHWAY (*Highway Name*)
FOR FARM ACCESS

“Access Key Phrase”: CONTROLLED TO HIGHWAY (*Highway Name*)
FOR FARM CROSSING

Application

Similar to a standard R/W acquisition that establishes an access reservation, except a specific purpose is identified for the use of the access reservation. The deed language will state that it is either for Farm Access or Farm Crossing only; any other uses will be prohibited. Later lifting of either of these use restrictions will require a Grant of Access. Normally there is a clause in the deed for a Farm Crossing that automatically extinguishes the access rights if and when there is not unity of ownership on both sides of the highway. Farm Crossing reservations should be in pairs, at the same Engineer’s Station on opposite sides of the highway.



Access Control: 374.405 – No abutter's rights of access (Complete Restriction To Highway)
Access Control: 374.405 – No abutter's rights of access (With Reservation Of Access Granted)

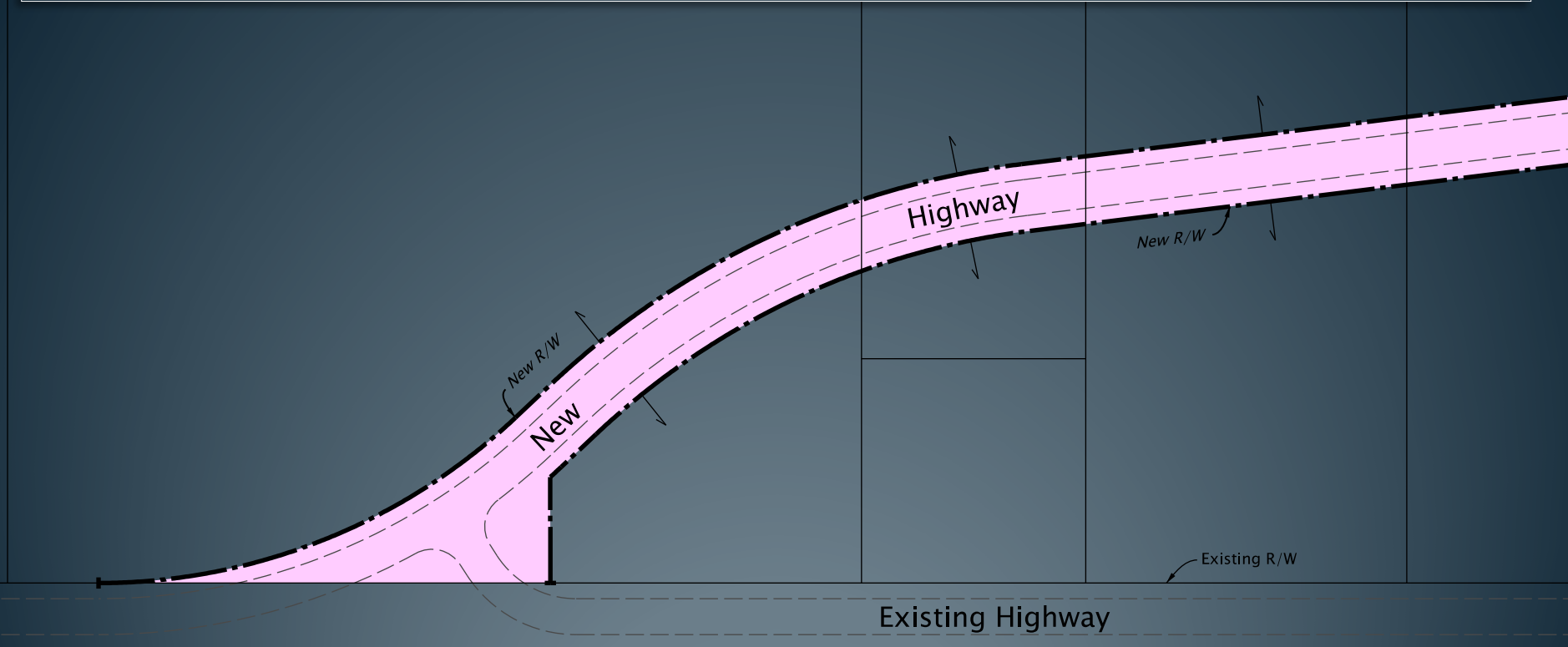



R/W File Addendum note

“Access Key Phrase”: ORS 374.405 – NO ABUTTER’S RIGHTS OF ACCESS (COMPLETE RESTRICTION TO HIGHWAY)”

Deed Language

Pursuant to Oregon law, ORS 374.405, there is no right of access to or from the remainder of Grantor's parcel(s) and any highway constructed on the property subject of this conveyance.

Application

This is a brand new alignment, no part of the R/W width existed prior to 1951. The default effect of ORS 374.405 prohibits access to the new R/W alignment.



R/W File Addendum note

“Access Key Phrase”: ORS 374.405 – NO ABUTTER’S RIGHTS OF ACCESS (WITH RESERVATION OF ACCESS GRANTED)”

Deed Language

Pursuant to Oregon law, ORS 374.405, there is no right of access to or from the remainder of Grantor's parcel(s) and any highway constructed on the property subject of this conveyance EXCEPT however,

Reserving access rights for the service of Grantor's remaining property, to and from said remaining property to the abutting highway at the following place(s), in the following width(s):

Hwy. Engr's Sta.	Side of Hwy.	Width
------------------	--------------	-------

Application

This is a brand new alignment, no part of the R/W width existed prior to 1951. This phrase is used only when the ORS 374.405 applies and there is to be a reservation(s) of access granted. Project team to provide the reservation station(s), which side of the highway and the width of the reservation(s).



ACCESS RIGHTS

Property "A" has access to the existing highway. No reservations of access need to be granted to the new alignment.

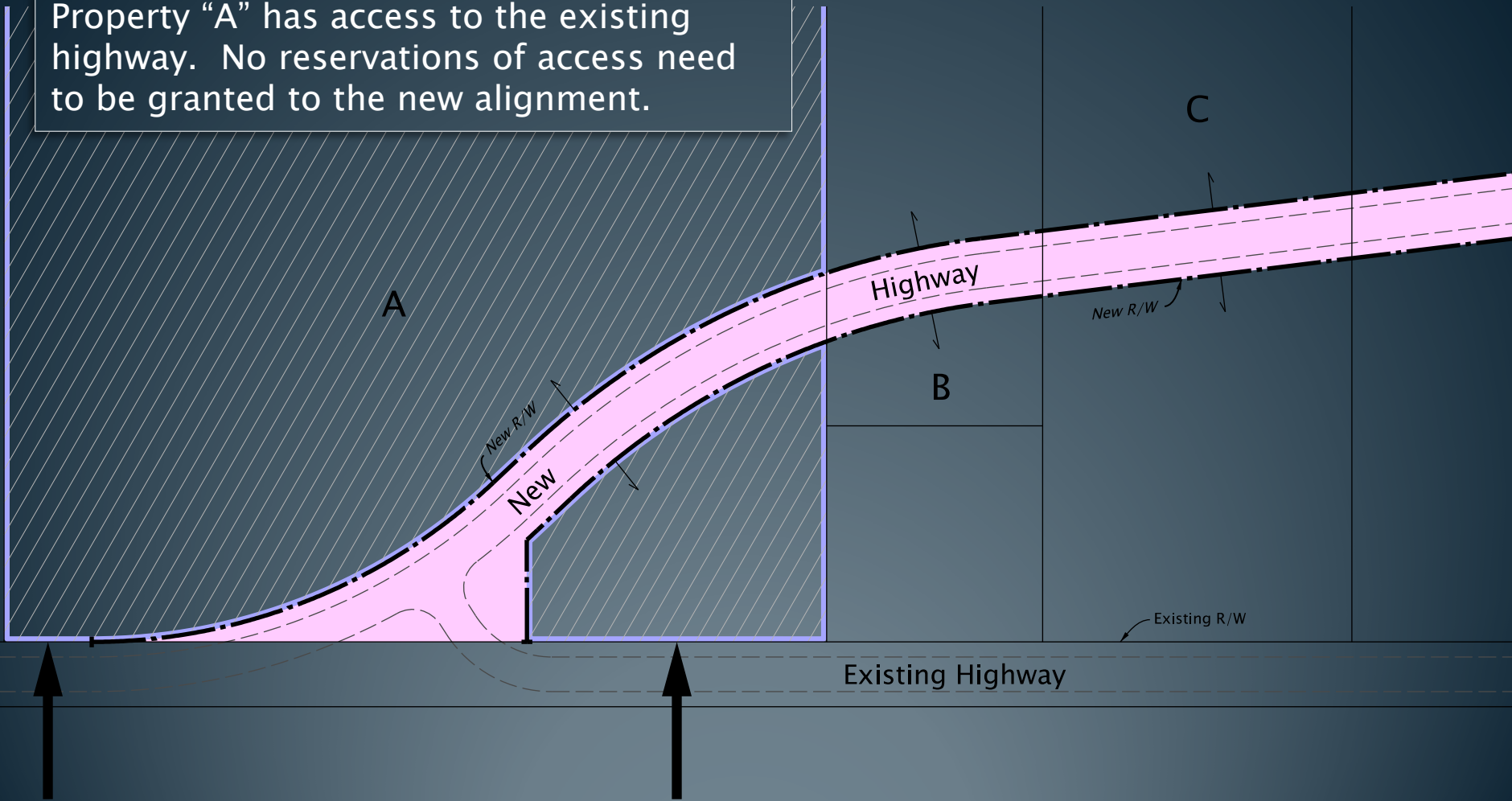



Property "B" does not have access to the existing highway. If alternative access does not exist for Northerly portion of the property, then a reservation must be granted or the property purchased.

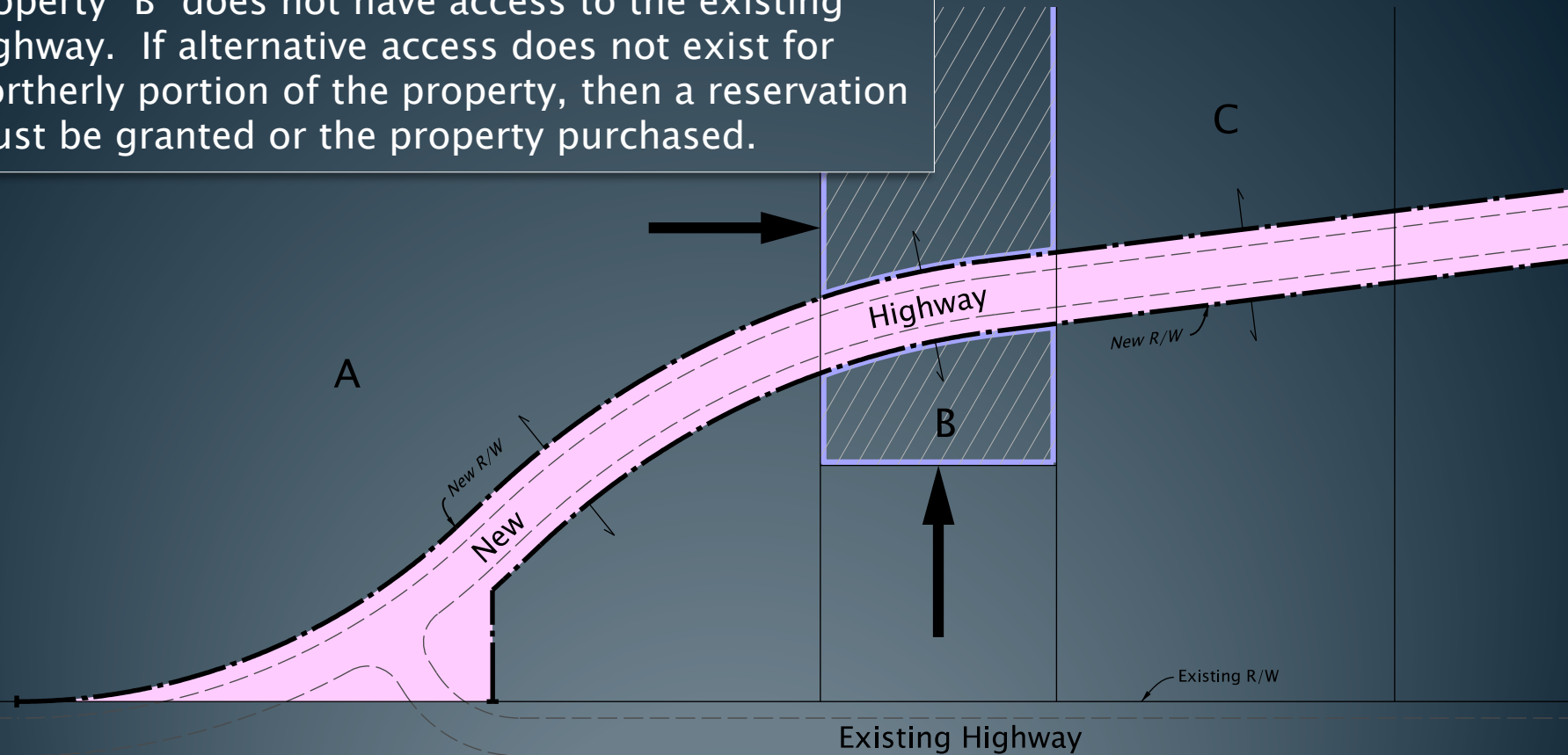

No alternative access exists for the Southerly portion of the property. A reservation of access must be granted or the property purchased.



Property "C" does not have access to the existing highway on the Northerly portion of the property. Reservation of access must be granted if no alternative access exists or the property purchased.

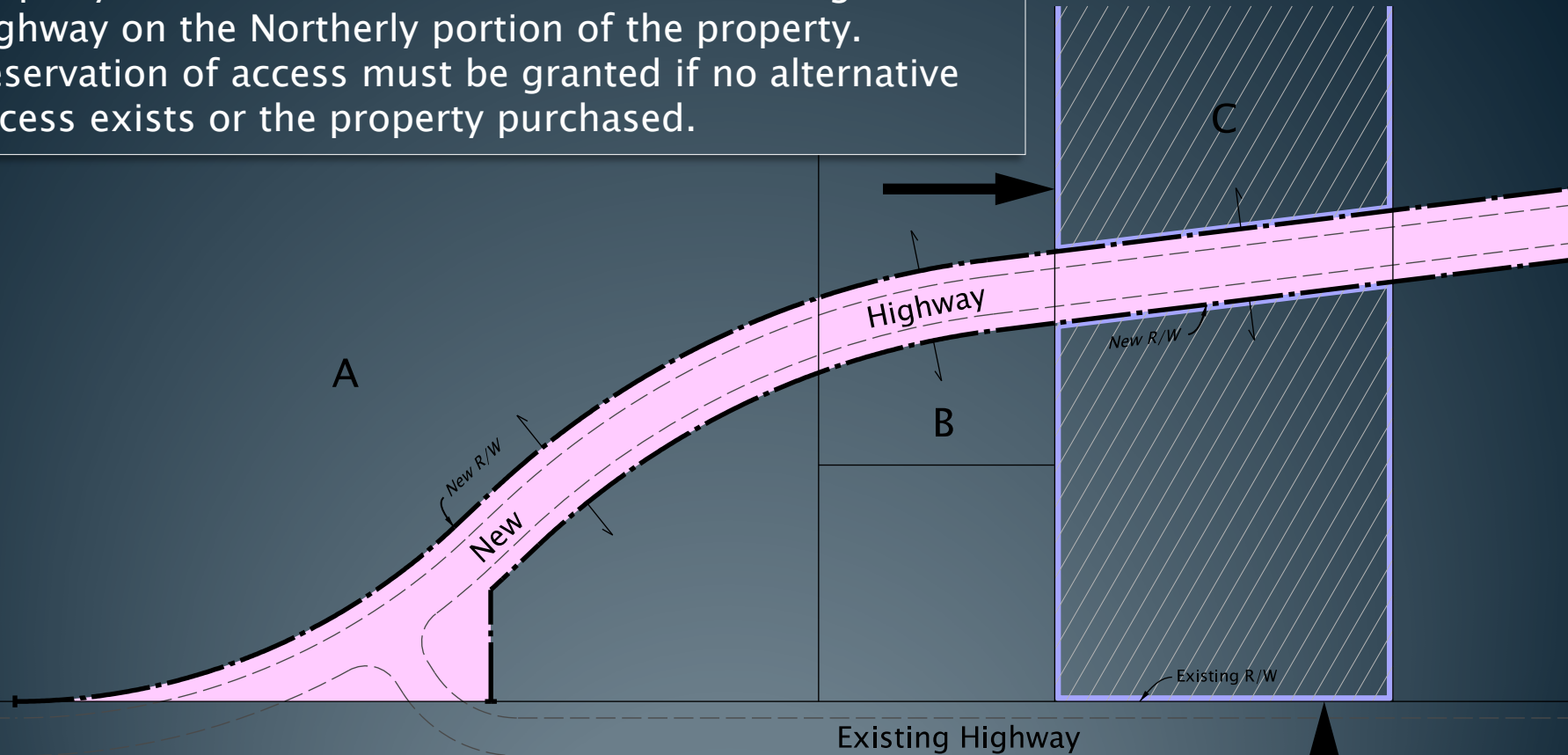

The Southerly portion of the property has access to the existing highway. A reservation of access does not need to be granted to the new alignment.



Access Control: Undercrossing

Undercrossing reservation granted to cross under the highway. The crossing is usually associated with a bridge or culvert structure.

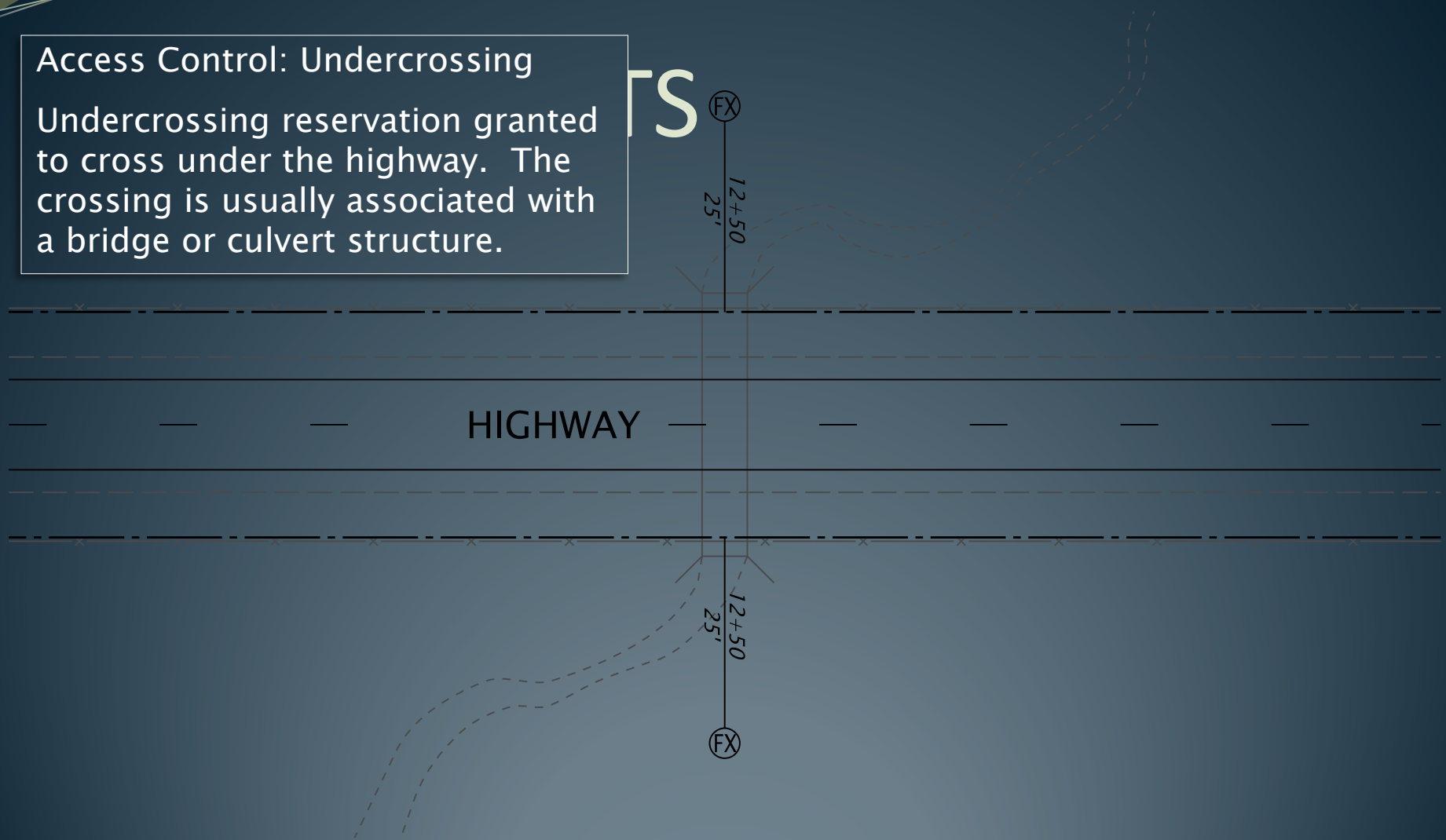



R/W File Addendum note

“Access Key Phrase”: Undercrossing”

Deed Language

TOGETHER WITH all abutter's rights of access between the *Name of Highway* and Grantor's remaining real property, EXCEPT, however,

Grantor reserves the right to cross beneath the highway structure, at Engineer's Station XX+XX.XX in widths to be determined by permit, to serve remaining property on the *direction* and *direction* sides of the highway. Grantor shall be liable for any damage to the highway structure incurred as a result of the exercise of this crossing right.

Application

Similar to a reservation for Farm Crossing. The deed language will state the allowed uses for the undercrossing; any other uses will be prohibited. The under-highway road may only be constructed or maintained upon issuance of a permit and in accordance with such permit. If the State constructs the under-highway road during a highway project, the grantor is required to sign an under-highway road permit to ensure proper operation and maintenance of the under-highway road. The use of the undercrossing shall not interfere with the use of the land for highway purposes and, in the event of conflict, the State shall terminate the reservation upon notification and compensation to the grantor.



ACCESS RIGHTS

FIRST ST.

SECOND ST.

Access control bounded by
Engineer's Station

10+00

001

STATE HIGHWAY (MAIN ST.)



ACCESS RIGHTS

R/W File Addendum note

“Access Key Phrase”: Completely restricted to highway (*Name of Highway*) *direction* of Engineer’s Station XX+XX.XX.”

“Access Key Phrase”: Completely restricted to parcel *direction* of Engineer’s Station XX+XX.XX.”

Application

This method is used for restricting the access rights between the grantor’s property and a portion of the frontage of the highway or the parcel. The restriction of access rights is from a specified cardinal direction of a specified Engineer’s Station. All existing access rights to the highway or to the parcel, if any, outside of the frontage we are restricting will remain.



ACCESS RIGHTS

R/W File Addendum note

“Access Key Phrase”: Controlled to highway (*Name of Highway*) *direction* of Engineer’s Station XX+XX.XX.”

“Access Key Phrase”: Controlled to parcel *direction* of Engineer’s Station XX+XX.XX.”

Application

This method is used for limiting the access rights between the Grantor’s property and a portion of the frontage of the highway or the parcel. The limitation of access rights is from a specified cardinal direction of a specified Engineer’s Station. Access between the grantor’s remaining property and the highway or the parcel frontage being controlled can only be through an access reservation. The R/W agent is expected to provide the width and Engineer’s Station for any new access reservation. All existing access rights to the highway or to the parcel, if any, that are opposite the specified direction of the Engineer’s Station will remain.



ACCESS RIGHTS

For more information on right of way engineering, refer to the Right of Way Engineering Manual, available on the ODOT web site.