

OREGON HIGHWAYS SEISMIC **PLUS** REPORT



Bridge and Geo-Environmental Sections
Technical Services Branch
Oregon Department of Transportation

October 2014

**OREGON HIGHWAYS
SEISMIC PLUS REPORT**





PREFACE 4

EXECUTIVE SUMMARY 5

BACKGROUND 10

APPENDICES

Appendix A: Program Cost Componets and Assumptions	24
Appendix B: Seismic Options Report Background Material.....	28
Appendix C: Lifeline Selection Summary Report.....	57
Appendix D: Excerpt from 2009 Seismic Vulnerability Study	70
Appendix E: Learning and Innovation Through Research	81
Appendix F: Oregon Seismic Retrofit Design Philosophy	82
Appendix G: Seismic Plus Economic Analysis: Major Earthquake Occurs.....	84
Appendix H: Seismic Plus Economic Analysis: Major Earthquake Does Not Occur.....	105

PREFACE

What's new in Plus?

This is an updated version of the original Seismic Options Report published in March 2013. The previous version presented the seismic bridge retrofit as a stand-alone program. The program cost and implementation approach was simplified by focusing only on seismic retrofit work on bridges and mitigation of unstable slopes along proposed lifeline routes.

The ODOT Bridge Section has since evaluated a variety of options for blending the seismic mitigation effort with other bridge structural needs. Retrofitting bridges in poor health does not make good sense, so ODOT has looked for opportunities where it is more cost-effective in the long term to replace aging bridges, as well as for cases where retrofits can be combined with repair projects to extend a bridge's life.

This report lays out a comprehensive program that will address seismic vulnerability, as well as mitigate structural deficiencies. The Seismic Plus Program presents the most economical option for mitigating several bridge deficiencies at once, including seismic vulnerability. This program will deliver longer lasting bridges and a seismically resilient transportation network and economy for Oregon.

EXECUTIVE SUMMARY

The Earthquakes in Oregon's Future – Anticipating the Economic Consequences

A Cascadia Subduction Zone earthquake with a magnitude of 8.0 or greater will hit Oregon; the question is when, not if. Such an earthquake will cause an unparalleled economic and human catastrophe for the state of Oregon.

Unfortunately, in its current state, the transportation system will be of little help in facilitating emergency response and long-term recovery after a Cascadia Subduction Zone quake. A magnitude 8.0 or greater quake will cause widespread disruption of Oregon's transportation system, making rescue operations difficult, if not impossible. Most bridges in western Oregon will suffer serious damage or destruction in a major seismic event because they were built before the existence of modern seismic codes. In addition, dozens of unstable slopes and

ODOT's responsibility has become clear: retrofit all seismically vulnerable bridges and address unstable slopes on key lifeline routes to allow for rescue and recovery following a major earthquake.

pre-existing deep slides will fail during the extended three minutes or more of shaking produced by a large Cascadia event. Virtually all major highways will be closed in the immediate aftermath of a quake; it will take months to open many highways—and years before mobility is fully restored.

In the meantime, Oregon's trade-based economy will falter due to severe limitations on moving people and goods. Experience with other large-scale disasters around the world shows that many firms will fail within the first few months, while others will move outside Oregon to avoid collapse; many that remain will struggle to maintain access to markets, resources and workers due to the lack of mobility on major highways.

The Need for Retrofitting

Given the economic impacts, the question is: what can Oregon do to increase the resilience of our highway system so we can be prepared to rescue our citizens and recover our economy in the face of this inevitable reality?

Fortunately, there are ways to keep the highway system functional after a quake. Seismic retrofitting of bridges is a well-developed and well-understood practice that has been extensively accomplished in Oregon's neighboring states of California and Washington. Due to the more frequent occurrence of earthquakes in those states, departments of transportation there have received significant seismic retrofit funds to mitigate impacts to their infrastructure.

Unlike its West Coast neighbors, Oregon has not experienced a large, damaging earthquake during the modern era, and our knowledge of the locations of faults and the geological history of major events is quite recent. In comparison to California and Washington, Oregon's earthquakes are much less frequent, but when they hit they are much larger and more damaging. In the absence of significant retrofitting, the highway system will not be functional immediately after a major seismic event and will cause sizable economic losses—estimated at \$355 billion over the course of seven years.

Pre-emptive seismic retrofitting could lessen the economic losses by 24 percent. This translates into reducing the loss by \$84 billion.

By keeping bridges open to commerce, the proposed program will have significant benefits to Oregon's economy even if we avoid a major earthquake.

Solution – A Strategic Approach: Phased Retrofitting

The total estimated cost to repair all seismically deficient bridges and unstable slopes is in the billions of dollars; however, this report outlines options for phased retrofitting that will provide the maximum degree of mobility with reasonable investments spread over several decades. ODOT has been working in cooperation with a variety of stakeholders and decision makers for the last 20 years to find solutions to this statewide problem. The most challenging decision is to determine when to begin these investments and how to generate the necessary revenue.

As part of the statewide effort to make the Oregon highway system seismically resilient, ODOT's responsibility has become clear: retrofit all seismically vulnerable bridges and address unstable slopes on key lifeline routes in a strategic and systematic program to allow for rescue and recovery following a major earthquake.

- Many bridges along Oregon state highways are in relatively good condition, with many years of remaining service life absent a major seismic event, and could benefit from a standalone retrofit project.
- Some bridges are not good candidates for seismic retrofit due to structural and other condition issues. Most of these bridges were built in the 1950s and 1960s, and many were built over poor soils which can amplify the seismic forces the bridge must endure during a seismic event.
- Other bridges will need to be replaced within the next several decades, and it makes no sense to retrofit a bridge only to replace it within a decade; for these structures, replacement will be more cost-effective in the long term than retrofit.
- Still other bridges will need significant rehabilitation work, and there would be significant cost benefits to combining retrofit and repair projects.

SEISMIC PLUS PROGRAM State Highway Network

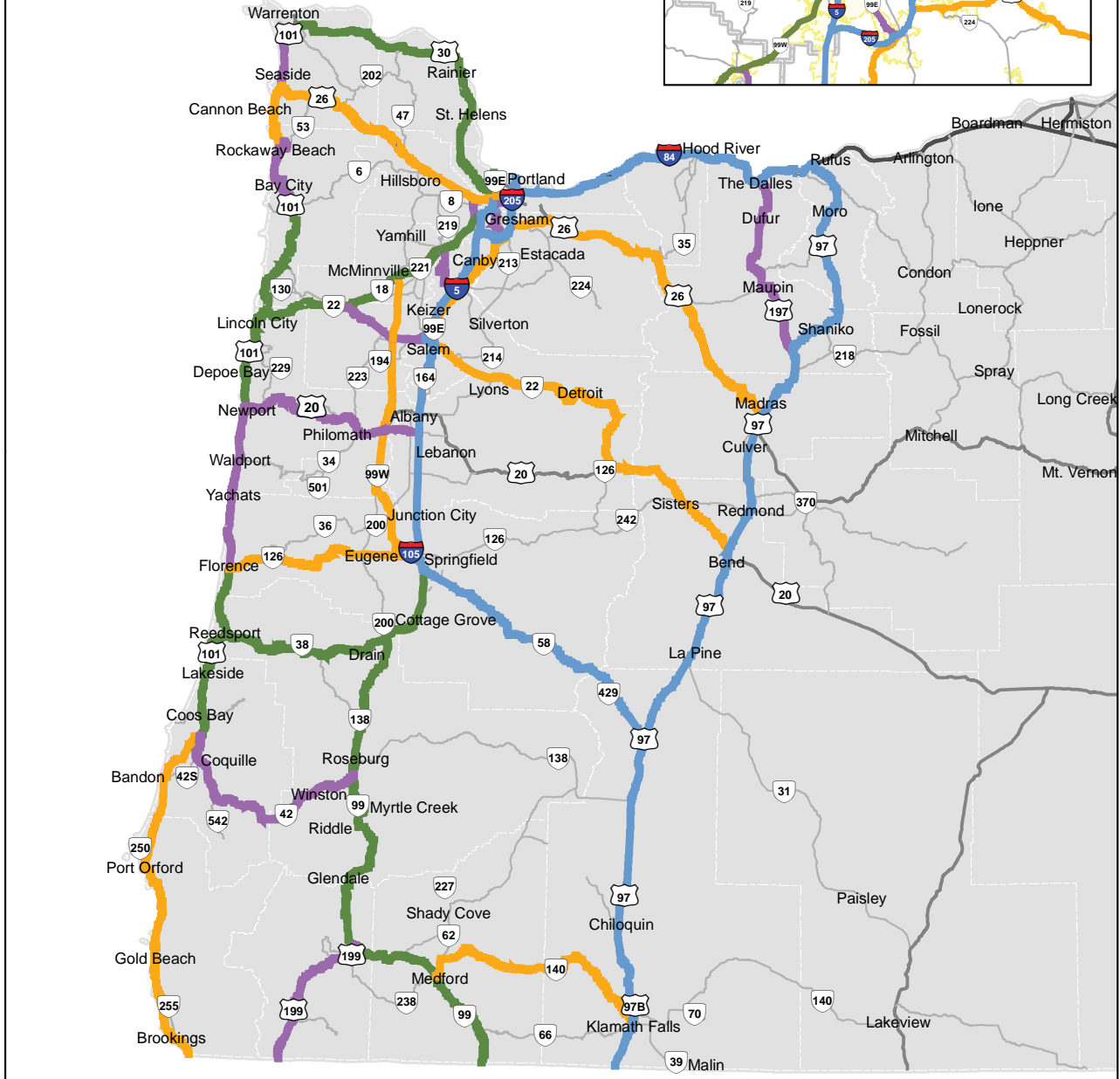
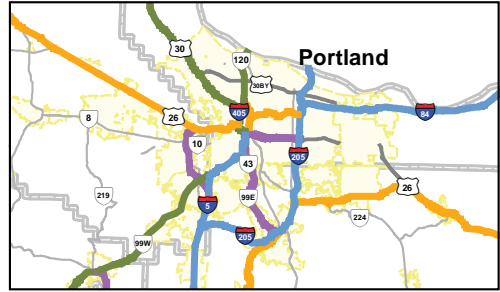

LEGEND

- Program Phase 1
- Program Phase 2
- Program Phase 3
- Program Phase 4
- Phase 5 (replacements) not shown for clarity
- Interstate
- U.S. Routes
- Oregon Routes
- County
- City Limits

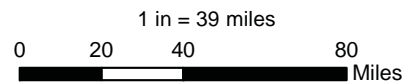

This product is for informational purposes and may not have been prepared for, or be suitable for, legal, engineering, or surveying purposes. Users of this information should review or consult the primary data and information sources to ascertain the usability of the information.



August 2014

In order to establish the most cost effective investment plan, ODOT conducted additional studies on key lifeline routes to identify long term bridge needs and to develop a program level assessment of bridge improvement needs. Combining selective bridge replacements and bridge rehabilitation work with seismic retrofit of bridges will result in cost savings on project design, construction, and project management, as well as reduced user delay cost when compared to undertaking a separate rehabilitation and replacement program. The effect, when combined with the mitigation of unstable slopes, is a cost-effective program that improves the overall condition and resiliency of Oregon's key lifeline routes.

By keeping bridges open to commerce that would otherwise decay and restrict the movement of freight, the proposed program will have significant benefits to Oregon's economy even if we avoid a major earthquake. An analysis indicates the investments in bridge replacements and rehabilitation made over the initial two decades of the Seismic Plus Program will avoid the loss of 70,000 jobs by 2035, compared to the significant deterioration in bridge conditions that will occur with the current levels of investment in bridges. This benefit occurs regardless of whether Oregon suffers a major earthquake and is in addition to the significant economic losses the Seismic Plus Program prevents in the event of an earthquake.

Recommendations

The following recommendations flow from the Oregon Resilience Plan and the Resilience Task Force's Implementation Plan.

Recommendation 1

Put an investment package into place immediately to begin a strategic bridge retrofitting, repair and replacement and unstable slope mitigation program on key lifeline routes.

Recommendation 2

Implement the strategic investment plan in five phases that build on each other over the next several decades. ODOT would complete the first phase of high-priority backbone routes within a decade, with each additional phase following within a decade or less, depending on the resources made available. This will minimize impacts to state and local economies and to users, while maximizing results at lower costs. This strategy anticipates that ODOT will continue to fund its continuing bridge rehabilitation and replacement program, even as it shifts to a corridor-based approach for implementation of the seismic program.

By the numbers:

138 bridges to be replaced

390 bridges to be retrofitted

190 bridges to be rehabilitated and retrofitted

1185 landslides and rockfalls to be mitigated

The following table shows the program cost and its components for each of the five phases.

Program Phases	Total Bridges Cost		Landslides/Rockfalls Cost		Total Seismic PLUS Program Cost (\$)
	No. of Bridges	Cost (\$)	No. of Slides/Rockfalls	Cost (\$)	
1	187	\$ 738,063,042	64	\$ 197,659,690	\$ 935,722,732
2	195	\$ 631,903,411	157	\$ 272,032,450	\$ 903,935,861
3	165	\$ 612,111,479	671	\$ 483,183,300	\$ 1,095,294,779
4	159	\$ 640,079,763	293	\$ 126,120,930	\$ 766,200,693
5	12	\$ 1,432,253,140	0	\$ 0	\$ 1,432,253,140
SubTotal	718	\$ 4,054,410,836	1185	\$ 1,078,996,370	\$ 5,133,407,206

Table1: Seismic Plus Program Cost Summary

BACKGROUND

“The Nisqually Effect”

A major damaging earthquake hit the Olympia, Washington area near Nisqually just before 11:00 AM on Ash Wednesday, February 28, 2001. This magnitude 6.8 seismic event shook buildings, rattled nerves and rolled the ground in Western Washington for about 45 seconds. This was an “interplate” earthquake due to a slip between the Juan de Fuca and the North America tectonic plates. Similar events had hit Olympia in 1949 and Tacoma in 1965.

The damage from this quake was estimated to be between \$1.0 and \$2.0 billion and nearly 400 people were injured. Fortunately, only one person died that was indirectly attributed to the earthquake.

Most of the damage was sustained by buildings. The major structures that had significant damage included the Washington State Capitol, the control tower at the Seattle-Tacoma International Airport, and several unreinforced masonry or concrete buildings in the Pioneer Square and Sodo neighborhoods of Seattle.

Only three bridges had significant damage because they had not been retrofitted yet. They included the Alaskan Way Viaduct and Magnolia Bridge in Seattle and the Fourth Street Bridge in Olympia.

The real success story from this earthquake was that 183 bridges that had been seismically retrofitted in the immediate area of the event had no damage. The routes over those bridges were available for emergency traffic very soon after the event and within about three days the bridges were inspected and opened to public travel. This excellent performance of the retrofitted bridges made it possible to assist those who were injured in a timely way and to recover economically in the area hit by the quake.

At least 20 percent of businesses surrounding the heavily affected area took direct losses from the earthquake while only 2 percent had direct losses of over \$10,000. Indirect losses varied from inventory or data corruption, disruption in the workplace, productivity, etc. Historically, the earthquake magnitude has served as a measuring stick for the preliminary assessment of casualties and earthquake damage. However, the worldwide experience has shown that other factors such as hypocenter location, building and infrastructure conditions, and preparedness level of affected region have as much impact on earthquake losses. While Nisqually earthquake was a 6.8 moment magnitude that caused \$2 billion damage, the Northridge earthquake was a 6.7 moment magnitude that caused more than \$20 billion worth of damage, as the hypocenter of the Northridge Earthquake was much shallower and closer to the surface of the earth.

In comparison, a Cascadia Subduction Zone event in western Oregon will result in ground motions, injuries, death, financial impacts, and time to recover up to 100 times that of the Nisqually earthquake. But, just like at Nisqually, if we retrofit the highway network, we can substantially reduce those impacts and the recovery time.

Recommendations

The appendices to this report document the process and include substantial information that was used to develop these recommendations. This includes the identification of key lifeline routes and the economic modeling of the impacts to Oregon beyond damage to the highway infrastructure. The following recommendations flow from the Oregon Resilience Plan and the Resilience Task Force's Implementation Plan.

Recommendation 1

Put an investment package into place immediately to begin a strategic bridge retrofitting, repair and replacement, and unstable slope mitigation program on key lifeline routes.

Recommendation 2

Implement the strategic investment plan in five phases that build on each other over the next several decades. ODOT would complete the first phase of high-priority backbone routes within a decade, with each additional phase following within a decade or less, depending on the resources made available. This will minimize impacts to state and local economies and to users, while maximizing results at lower costs. This strategy anticipates that ODOT will continue to fund its continuing bridge rehabilitation and replacement program, even as it shifts to a corridor-based approach in implementation of the seismic program.

The recommended phases are outlined below. The total cost to address the seismic problem is estimated at \$5.1 billion in current dollars. This recommendation corrects the bridge and landslide/rockfall deficiencies using a strategic lifeline route-based approach.

Program Summary

The seismic program costs are based on planning level estimates for each of its main components: bridge replacement, bridge rehabilitation, seismic retrofit and landslide/rockfall mitigation costs.

The seismic program cost is presented in 2013 dollars and does not include inflation during the implementation of the phases. To keep up with escalating costs, revenue sources would need to grow with inflation.

Bridge Conditions and the Seismic Program

The Oregon Transportation Investment Act (OTIA) III Bridge Program made a significant overall improvement in bridge conditions during the last ten years, particularly on major freight routes. Bridge conditions improved both through the replacement of a portion of the bridge inventory and the rehabilitation of additional bridges.

A secondary effect of the program was to increase the seismic resiliency of some of the bridge inventory through bridge replacement and limited seismic retrofitting. One hundred and twenty-two bridges were replaced with new bridges designed to meet modern seismic criteria. In addition, seismic retrofits were completed on six bridges that were also strengthened or rehabilitated. This completed work reduces the number of bridges to be included in the recommended seismic program.

However, limited resources are available for continued seismic work. Because ODOT's annual Bridge Program has been reduced to cover bond payments for OTIA III, almost all of ODOT's limited funding is used for bridge repairs that extend the life of aging bridges; virtually no funding is available for bridge replacements or seismic retrofits that render the system more resilient to a major earthquake.

Bridges are currently in good condition as a result of OTIA III, with just 20 percent of state highway bridges rated as distressed. However, future Bridge Program funding will be inadequate to cover the increasing needs of Oregon's aging state highway bridges. As a result, bridge conditions will deteriorate significantly, and by 2050 more than three quarters of state highway bridges will be distressed. This will cause the closure of many bridges to heavy trucks, forcing long detours that will impose significant burdens on Oregon's trade-based economy. ODOT economic analysis indicates that as a result of deteriorating highway conditions the state will forfeit about 100,000 jobs by 2035.

The Seismic Plus Program will help avoid this fate. By investing in the Seismic Plus Program, Oregon lifeline routes will be secured and significant improvement will be made to the overall structural conditions of Oregon's bridges. While the overall long-term need for bridges is more than \$200 million annually, the Seismic Plus Program would address about a quarter of the long-term need. At the end of the program, Oregon's state highway bridges will be in better condition than they otherwise would be.

Economic Effects of Recommendations

As found in the appendix G, ODOT's study of the economic benefits of a state highway seismic program demonstrated that if the full retrofit program is completed prior to a major Cascadia seismic event, Oregon would avoid the loss of \$84 billion to the state's economy in the years following a major earthquake.

By keeping bridges that would otherwise decay and restrict the movement of freight open to heavy trucks, the proposed program will have significant benefits to Oregon's economy even if we avoid a major earthquake. ODOT's analysis (see Appendix H) indicates the investments in bridge replacements and rehabilitation made over the initial two decades of the Seismic Plus Program will avoid the loss of 70,000 jobs by 2035, compared to the significant deterioration in bridge conditions that will occur with the current levels of investment in bridges. This benefit occurs regardless of whether Oregon suffers a major earthquake and is on top of the significant economic losses avoided by the Seismic Plus Program in the event of an earthquake.

SEISMIC PLUS PROGRAM Phase 1

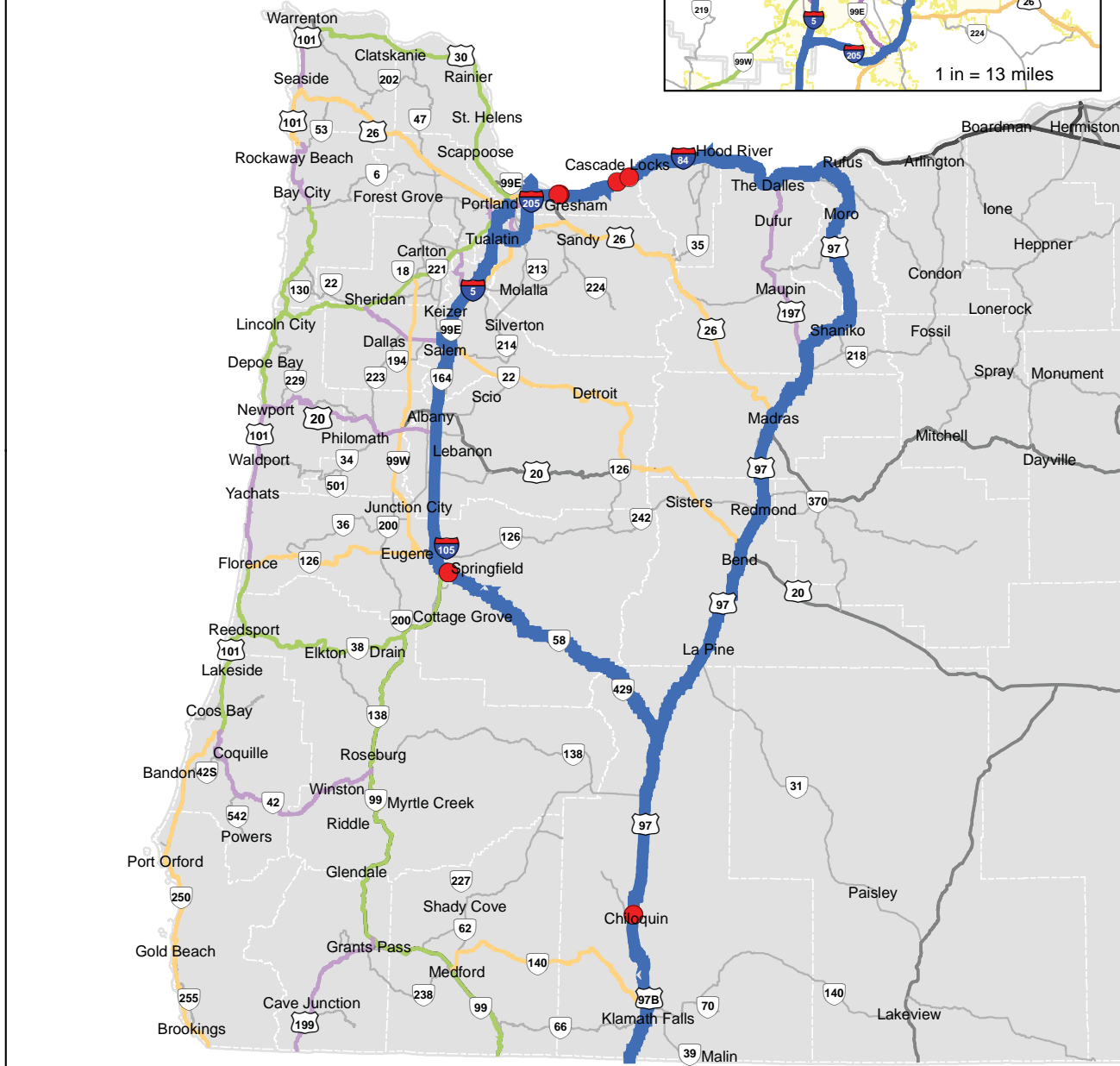
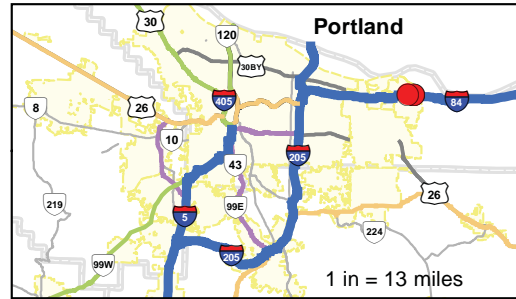

LEGEND

- Bridge to be Replaced
- Program Phase 1
- Program Phase 2
- Program Phase 3
- Program Phase 4
- Interstate
- U.S. Routes
- Oregon Routes
- County
- City Limits

1 in = 39 miles

0 20 40 80 Miles
0 5 10 20 Miles

This product is for informational purposes and may not have been prepared for, or be suitable for, legal, engineering, or surveying purposes. Users of this information should review or consult the primary data and information sources to ascertain the usability of the information.

August 2014

Phase 1

In case of a major seismic event in Oregon, the main help for affected areas is expected to come from the eastern part of our state and from our neighbor states. Redmond Airport will be used as the main hub for providing goods and medical supplies for those in need. Therefore, creating a resilient highway system that would provide East-West freight movement becomes an important task for our program. Because Phase 1 will serve as the cornerstone of the entire program, a smart corridor selection becomes critical for the success of this program. Starting the program with retrofitting less vulnerable segments appears to be the most economical approach with the highest return on investment.

Five very important corridors comprise Phase 1 of the Seismic Plus Options Program (see table 2.) This phase will establish the very first North-South resilient corridor, in addition to connecting the Redmond Airport with the most populated areas in the Willamette Valley.

The work included in Phase 1 consists of:

- ⊙ Replacing 7 bridges
- ⊙ Retrofitting 122 bridges
- ⊙ Retrofitting and rehabilitating 58 bridges
- ⊙ Mitigating 64 critical unstable slopes

The Total Cost of Phase 1 is estimated to be about \$936 Million (see table A1 in Appendix A)

Corridor No.	Hwy.	Description (Point to Point)
1	U.S. 97	I-84 to CA Border
2	I-84	I-205 to U.S. 97
3	I-205	WA Border to I-5
4	I-5 & OR 22 (Salem)	I-405 to OR 58
5	OR 58	I-5 to U.S. 97

Table 2: Phase 1 Highway Corridors

SEISMIC PLUS PROGRAM Phase 2

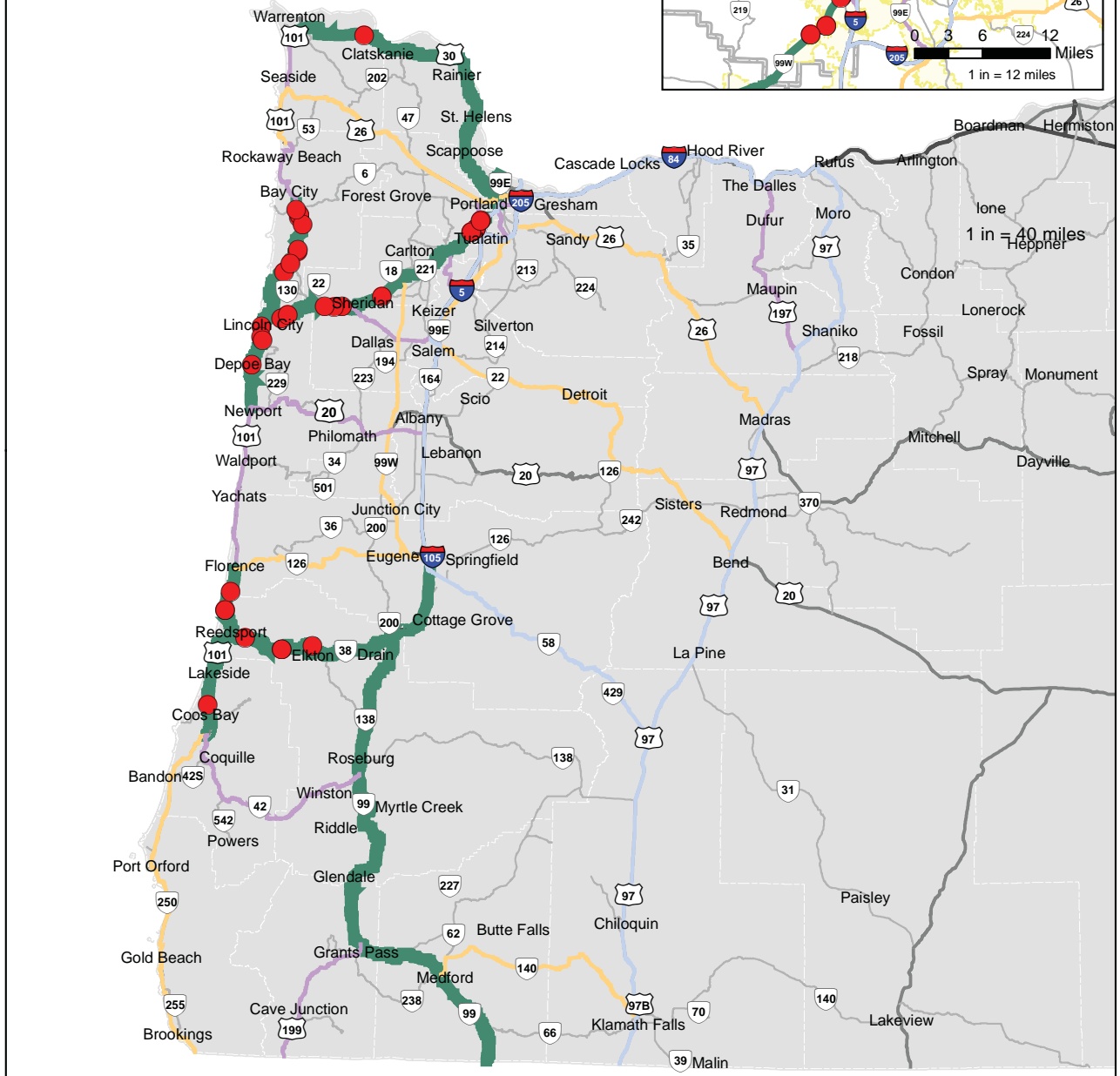
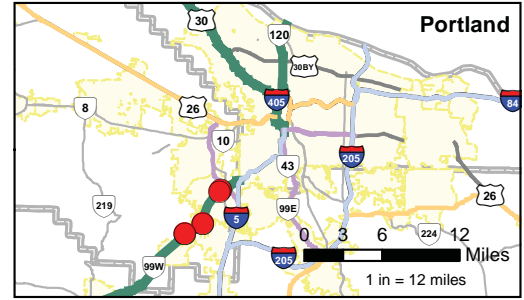

LEGEND

- Bridge to be Replaced
- Program Phase 1
- Program Phase 2
- Program Phase 3
- Program Phase 4
- Interstate
- U.S. Routes
- Oregon Routes
- County
- City Limits

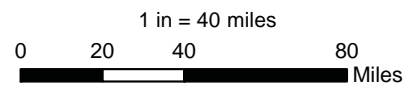

This product is for informational purposes and may not have been prepared for, or be suitable for, legal, engineering, or surveying purposes. Users of this information should review or consult the primary data and information sources to ascertain the usability of the information.



August 2014

Phase 2

Reaching out to the coastal communities is the main focus of Phase 2. Three important corridors connecting I-5 to US101 will be strengthened under this phase. Most of the population along the US101 will be connected to these three East – West corridors by strengthening a couple of US101 segments. Also, strengthening the remaining south portion of I-5 (all the way to California border) will provide the second North – South resilient corridor.

The work included in Phase 2 consists of:

- ⦿ Replacing **31** bridges
- ⦿ Retrofitting **108** bridges
- ⦿ Retrofitting and rehabilitating **56** bridges
- ⦿ Mitigating **157** critical unstable slopes

The Total Cost of Phase 2 is estimated to be about **\$904** Million (see table A2 in Appendix A).

Corridor No.	Hwy.	Description (Point to Point)	Corridor No.	Hwy.	Description (Point to Point)
6	I-405	U.S. 30 to I-5	11	U.S. 101	OR 18 to U.S. 20
7	U.S. 30	U.S. 101 to I-405	12	U.S. 101	OR 18 to Tillamook
8	OR 99W & OR 18	I-5 to U.S. 101	13	U.S. 101	OR 38 to OR 42
9	I-5	OR 58 to CA Border	14	U.S. 101	OR 38 to OR 126
10	OR 38	U.S. 101 to I-5	15	5 & I-405	WA Border to U.S. 30

Table 3: Phase 2 Highway Corridors

SEISMIC PLUS PROGRAM Phase 3

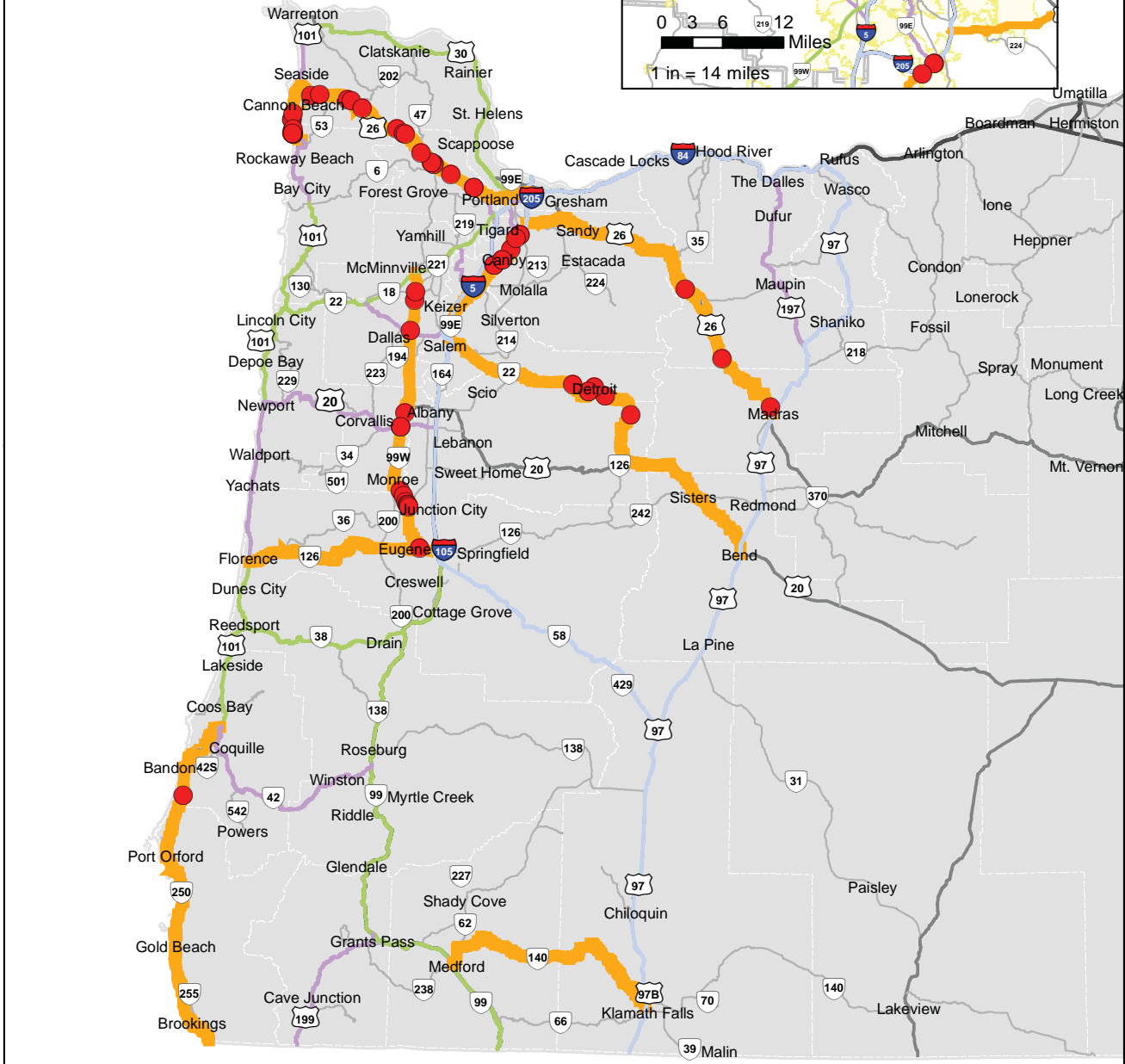
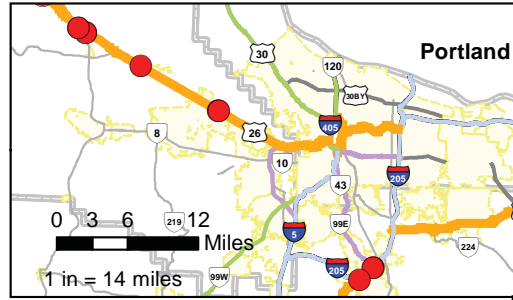

LEGEND

- Bridge to be Replaced
- Interstate
- Program Phase 1
- Program Phase 2
- Program Phase 3
- Program Phase 4
- U.S. Routes
- Oregon Routes
- County
- City Limits

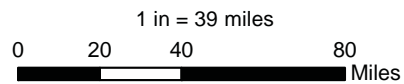

This product is for informational purposes and may not have been prepared for, or be suitable for, legal, engineering, or surveying purposes. Users of this information should review or consult the primary data and information sources to ascertain the usability of the information.



August 2014

Phase 3

Adding redundancy and capacity to the transportation network already strengthened in Phases 1 and 2 of the program is the focus of Phase 3. Three additional corridors will provide connection between US97 and I-5, thus reducing the response time significantly. Two additional corridors connecting I-5 to US101 and two additional strengthened segments of US101 will allow quicker access to coastal communities. It should be noted that strengthening a significant length of US101 (from Coos Bay all the way to California border) will provide the third point of entry (and maybe the most efficient one) for any help coming through California.

The work included in Phase 3 consists of:

- ⦿ Replacing **51** bridges
- ⦿ Retrofitting **74** bridges
- ⦿ Retrofitting and rehabilitating **40** bridges
- ⦿ Mitigating **671** landslides and rockfalls

The Total Cost of Phase 3 is estimated to be about **\$1,095** Million (see table A3 in Appendix A).

Corridor No.	Hwy.	Description (Point to Point)	Corridor No.	Hwy.	Description (Point to Point)
16	OR 22 & U.S. 20	I-5 to U.S. 97	22	I-5	I-84 to I-405
17	OR 140	I-5 to U.S. 97	23	OR-99W	OR 18 to I-5
18	U.S. 26	I-405 to U.S. 101	24	OR 126	OR 99W to U.S. 101
19	U.S. 101	OR 42 to CA Border	25	OR 99E & OR 214	I-205 to I-5
20	OR 212 & U.S. 26	I-205 to U.S. 97	26	U.S. 101	U.S. 26 to Nehalem
21	I-84	I-205 to I-5	27	I-5	I-84 to I-405

Table 4: Phase 3 Highway Corridors

SEISMIC PLUS PROGRAM Phase 4

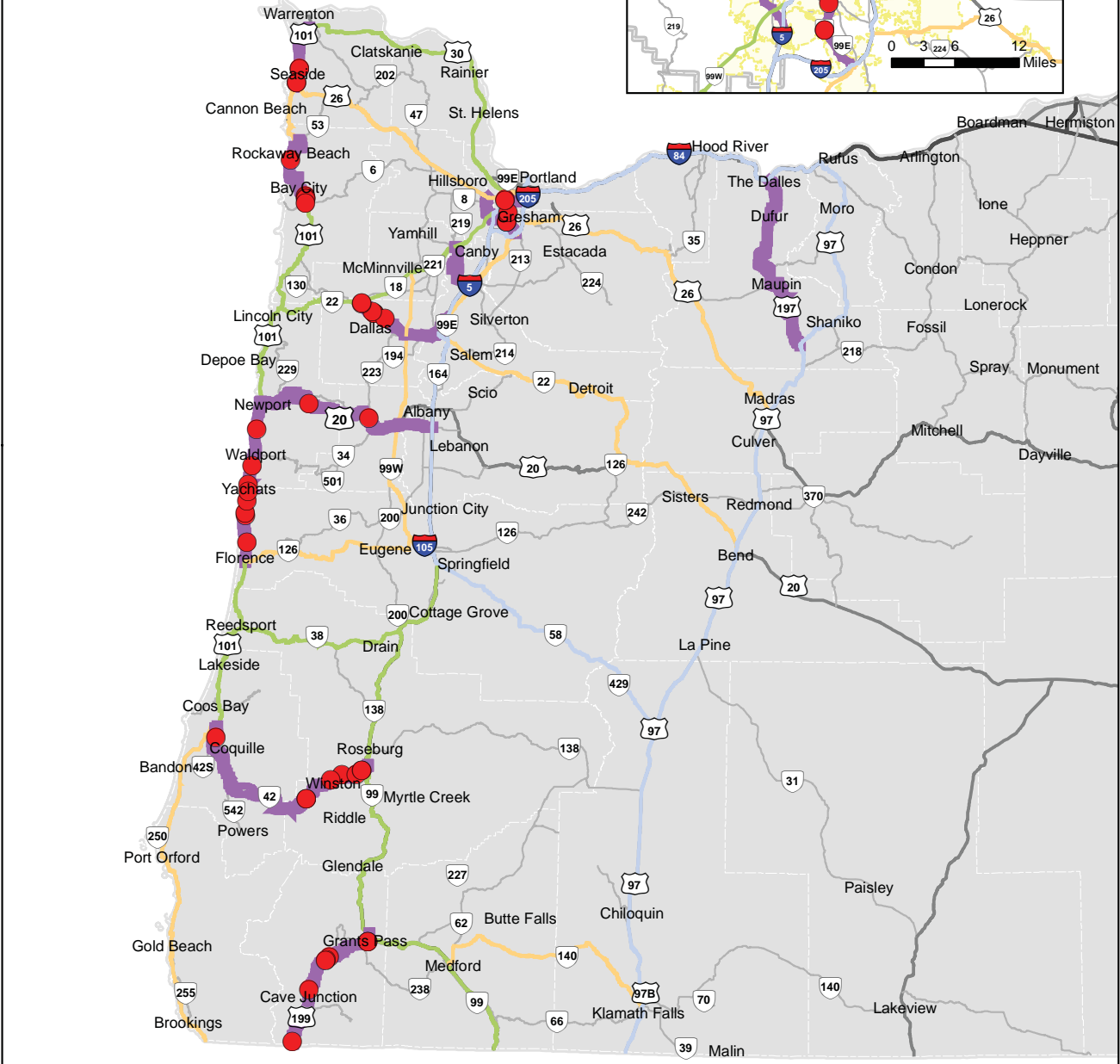
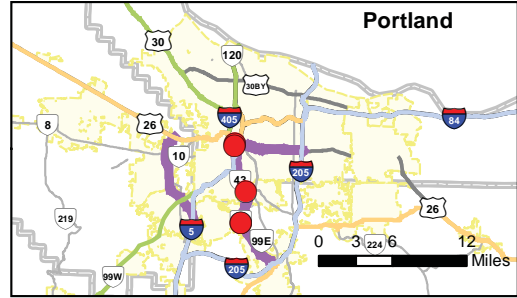

LEGEND

- Bridge to be Replaced
- Program Phase 1
- Program Phase 2
- Program Phase 3
- Program Phase 4
- Interstate
- U.S. Routes
- Oregon Routes
- County
-



This product is for informational purposes and may not have been prepared for, or be suitable for legal, engineering, or surveying purposes. Users of this information should review or consult the primary data and information sources to ascertain the usability of the information.



August 2014

Phase 4

Phase 4 of the program will finalize strengthening of all proposed Seismic Lifeline Corridors, with the exception of a dozen structures that will be replaced under Phase 5. Four additional East – West corridors connecting I-5 with the Oregon coast will be strengthened during this phase. One of these corridors, US199, can also be used as a detour option for connecting I-5 to California. Also, the remaining segments of US101 will be strengthened, thus providing a continuous resilient segment along the Oregon coast, a vital corridor for evacuation and rescue.

The work included in Phase 4 consists of:

- ⊙ Replacing **37** bridges
- ⊙ Retrofitting **86** bridges
- ⊙ Retrofitting and rehabilitating **36** bridges
- ⊙ Mitigating **293** landslides and rockfalls

The Total Cost of Phase 4 is estimated to be about **\$766** Million (see table A4 in Appendix A).

Corridor No.	Hwy.	Description (Point to Point)	Corridor No.	Hwy.	Description (Point to Point)
28	OR 99E & OR 22	I-5 to OR 18	34	OR 217	I-5 to U.S. 26
29	OR 34 & U.S. 20	I-5 to U.S. 101	35	U.S. 101	U.S. 30 to U.S. 26
30	U.S. 101	U.S. 20 to OR 126	36	U.S. 101	Nehalem to Tillamook
31	U.S. 199	I-5 to CA Border	37	OR 42	I-5 to U.S. 101
32	U.S. 26	I-5 to I-205	38	U.S. 197	I-84 to U.S. 97
33	OR 43	I-5 to I-205	39	OR 219	I-5 to OR 18

Table 5: Phase 4 Highway Corridors

SEISMIC PLUS PROGRAM Phase 5 Major Bridge Replacements

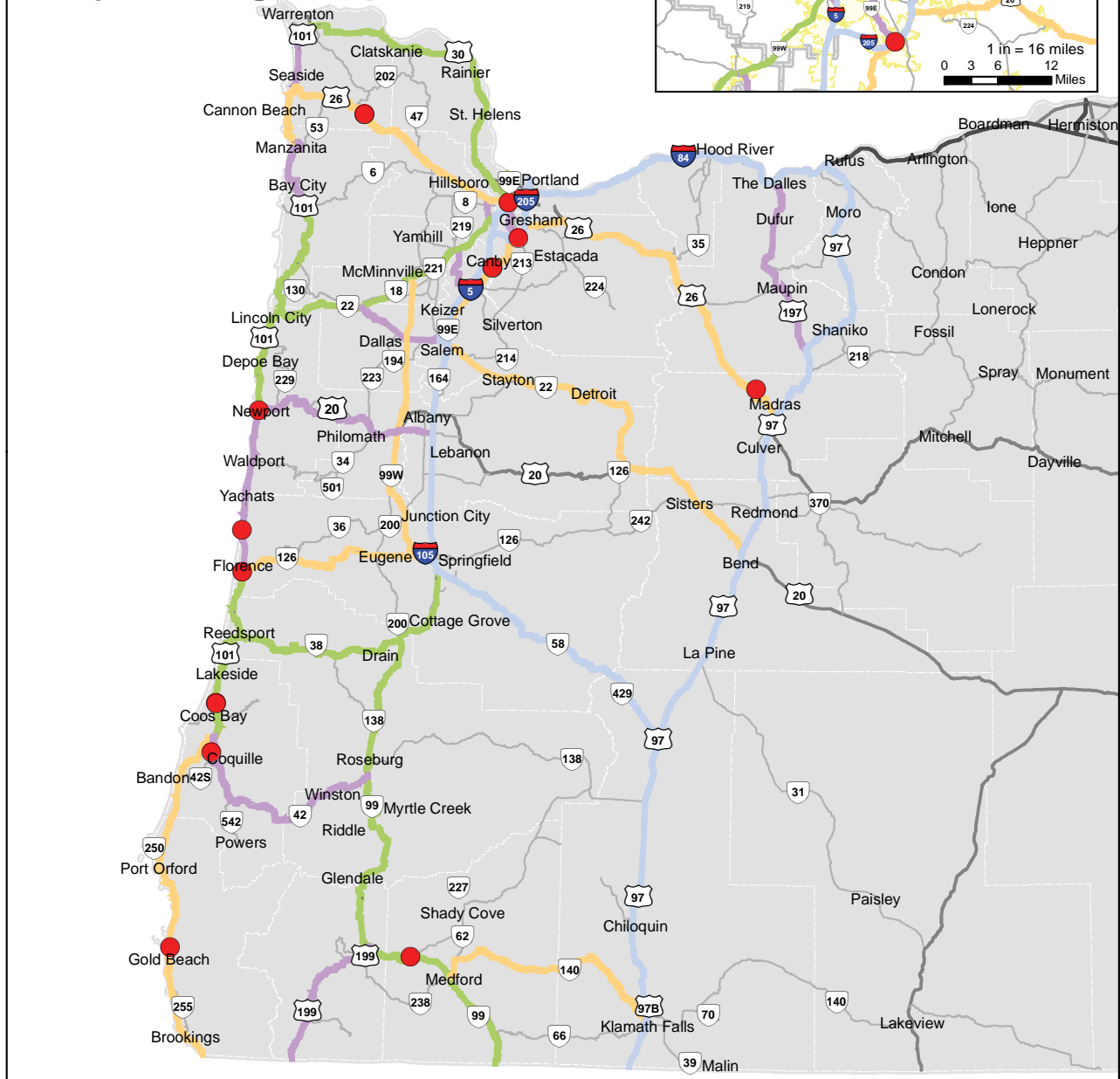
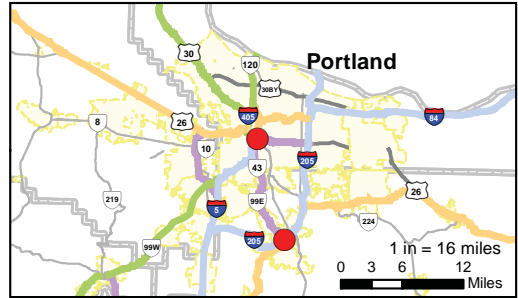

LEGEND

- Bridge to be Replaced
- Program Phase 1
- Program Phase 2
- Program Phase 3
- Program Phase 4
- Interstate
- U.S. Routes
- Oregon Routes
- County
-



This product is for informational purposes and may not have been prepared for, or be suitable for, legal, engineering, or surveying purposes. Users of this information should review or consult the primary data and information sources to ascertain the usability of the information.



August 2014

Phase 5

Phase 5 of the Seismic Plus Options Report consists of the replacement of twelve major bridges along all previously established corridors. These bridges are either unique and/or historic bridges, or significant in size. Phase 5 consists of bridge work only, since all unstable slopes along these corridors are already mitigated during the first four phases of program. These bridges are located all over the western part of our state, thus their construction is not expected to have significant impact on daily traffic. Also, design and construction cost can be minimized by making these projects accessible to a wider number of design and construction sources.

Table 6 provides detailed information on bridges planned for replacement under Phase 5. The Total Cost of Phase 5 is estimated to be about **\$1,432 Million**.

Phase 5 Total Cost **\$1,432,253,140**

Bridge Name	Highway	Mile Point	Replacement Cost
Medford Viaduct	I-5	28.66	\$373,810,000
Beaver Creek	OR 42 EB	5.37	\$15,942,960
SE Water Street Viaduct	OR 99E	12.29	\$15,075,060
Pudding River	OR 99E	24.67	\$41,180,000
Rogue River (Gold Beach)	US101	327.70	\$110,084,000
Coos Bay (McCullough)	US 101	233.99	\$307,690,000
Siuslaw River (Florence)	US 101	190.98	\$90,944,000
Cape Creek	US 101	178.35	\$40,252,000
Yaquina Bay	US 101	141.68	\$189,080,000
Willamette R & Hwy 1 & OPR	US 26	0.77	\$211,874,000
North Fork Quartz Creek	US 26	24.23	\$19,288,500
Deschutes River	US 26	105.24	\$17,032,620

Table 6: Phase 5 Detailed Cost

APPENDIX A

PROGRAM COST COMPONENTS AND ASSUMPTIONS

The seismic program costs are based on planning level estimates for each of its main components: bridge replacement, bridge rehabilitation, seismic retrofit and landslide/rockfall mitigation.

- Bridge replacement cost estimates are based on cost data from recent replacement projects. Unit costs of \$250-\$600 per square foot of deck area have been applied to the projected deck area of replacement bridges, based on bridge size and complexity. A minimum threshold replacement cost of \$3,000,000 is used.
- Bridge rehabilitation costs have been estimated based on anticipated bridge deficiencies and bridge cost data for similar repairs.
- Seismic retrofit costs included in the program are based primarily on the bridge damage state predicted by the REDARS2 computer model using a Magnitude 9.0 Cascadia Subduction Zone Earthquake scenario. A unit cost of \$35-\$80 per square foot of deck area is used depending on the predicted damage state of the bridge.
- The Interstate Bridge on I-5 that connects Portland to Vancouver has been identified to have significant seismic vulnerabilities and would collapse or be rendered unusable in an earthquake. Oregon and Washington developed the Columbia River Crossing project to replace the bridge with a seismically resilient structure and address other transportation deficiencies, but the project has not moved forward. Replacement of the Interstate Bridge is not included in the Seismic Plus report; because of the cost of addressing the Interstate Bridge, ODOT assumes that the bridge's deficiencies will be addressed through a project outside the scope of this program.
- Costs for mitigating unstable slopes and rockfalls are estimated based on the type and size of the anticipated repair and historical cost data for mitigating similar hazards.
- All seismic program planning level cost estimates are total project costs and include Preliminary Engineering, Construction Management and Construction Engineering costs.
- The seismic program cost is presented in 2013 dollars and does not include inflation during implementation of the phases.

Figure A1 and tables A1 through A4 show details of the total program costs and individual cost of each five phases.

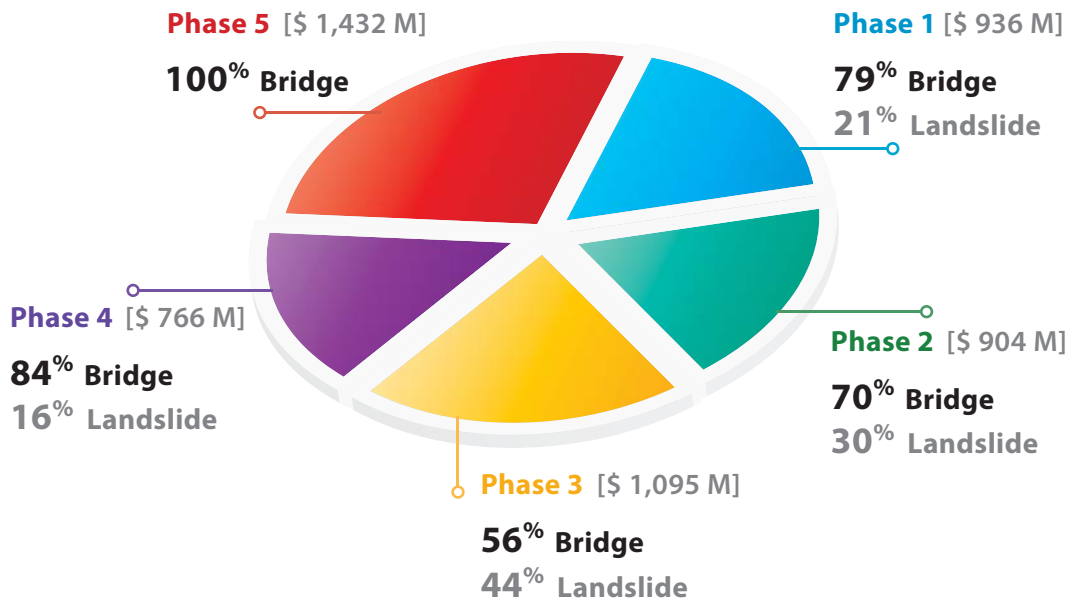
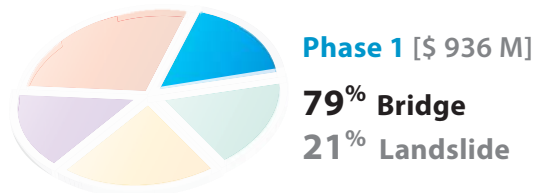

Figure A1: Program Main Components: Bridges and Landslides



Total Phase 1 Cost \$ 935,722,732

Bridge Total Cost

\$ 738,063,042

Mitigation Options	No. Bridges	Mitigation Cost (\$)
Replacement as More Cost Effective	7	\$ 47,516,520
Seismic Retrofit with Needed Rehab	58	\$ 428,850,148
Seismic Retrofit w/o Rehab	122	\$ 261,696,374

Landslides / Rockfalls Cost

\$ 197,659,690

No. of Landslides / Rockfalls	Mitigation Cost (\$)
64	\$ 197,659,690

Table A1: Phase 1 Detailed Cost

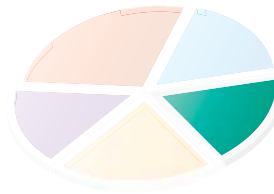

Phase 2 [\$ 904 M]

70% Bridge

30% Landslide

Total Phase 2 Cost \$ 903,935,861

Bridge Total Cost

\$ 631,903,411

Mitigation Options	No. Bridges	Mitigation Cost (\$)
Replacement as More Cost Effective	31	\$ 209,040,311
Seismic Retrofit with Needed Rehab	56	\$ 257,238,707
Seismic Retrofit w/o Rehab	108	\$ 165,624,393

Landslides / Rockfalls Cost

\$ 272,032,450

No. of Landslides / Rockfalls	Mitigation Cost (\$)
157	\$ 272,032,450

Table A2: Phase 2 Detailed Cost

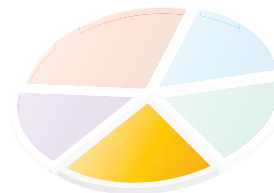

Phase 3 [\$ 1,095 M]

56% Bridge

44% Landslide

Total Phase 3 Cost \$ 1,095,294,779

Bridge Total Cost

\$ 612,111,479

Mitigation Options	No. Bridges	Mitigation Cost (\$)
Replacement as More Cost Effective	51	\$ 316,742,044
Seismic Retrofit with Needed Rehab	40	\$ 199,424,135
Seismic Retrofit w/o Rehab	74	\$ 95,945,300

Landslides / Rockfalls Cost

\$ 483,183,300

No. of Landslides / Rockfalls	Mitigation Cost (\$)
671	\$ 483,183,300

Table A3: Phase 3 Detailed Cost

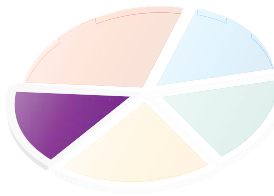

Phase 4 [\$ 766M]

84% Bridge

16% Landslide

Total Phase 4 Cost \$ 766,200,693

Bridge Total Cost

\$ 640,079,763

Mitigation Options	No. Bridges	Mitigation Cost (\$)
Replacement as More Cost Effective	37	\$ 233,961,357
Seismic Retrofit with Needed Rehab	36	\$ 294,396,065
Seismic Retrofit w/o Rehab	86	\$ 111,722,341
Landslides / Rockfalls Cost		\$ 126,120,930
No. of Landslides / Rockfalls		Mitigation Cost (\$)
293		\$ 126,120,930

Table A4: Phase 4 Detailed Cost

APPENDIX B

SEISMIC OPTIONS REPORT BACKGROUND MATERIAL

Seismic Risks To Oregon Highways

The primary seismic hazard in Oregon arises from the Cascadia Subduction Zone located along the Oregon coastline (Figures B1 and B2). This zone, which extends from northern California to British Columbia, is a convergent plate boundary, where the western edge of the North American tectonic plate collides with the eastern edge of the Juan de Fuca Plate. Relative plate motions result in the Juan de Fuca Plate sinking below the North American Plate and beneath the coasts of northern California, Oregon, Washington, and British Columbia. The North American Plate is also deforming as it accommodates strain along its boundaries with the Pacific and Juan de Fuca plates. While earthquakes along this zone are infrequent, those that do occur are very large. In addition, western Oregon is underlain by a large and complex system of faults that can also produce damaging earthquakes. These smaller faults produce lower magnitude events, but their ground shaking can be strong, and damage to structures located nearby can be great.

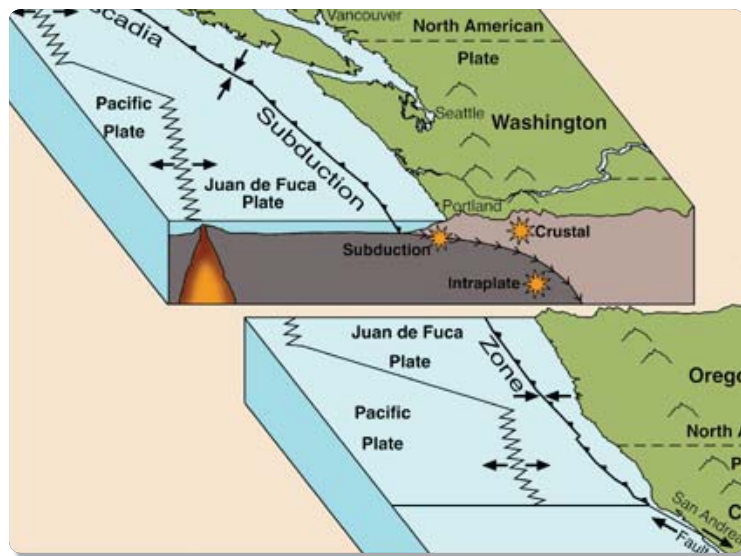

Figure B1: Cross-section of the Cascadia Subduction Zone showing the three principal sources of major earthquakes in Oregon. Source: Shoreland Solutions. Chronic Coastal Natural Hazards Model Overlay Zone, Salem. OR: Oregon Department of Land Conservation and Development (1998) Technical Guide-3

Three Sources of Earthquakes

The tectonic plate interactions described above result in the creation of faults and folds that generate most of the large earthquakes in the Pacific Northwest. Based on plate tectonic models and historical observations, major earthquakes in the Pacific Northwest that would affect Oregon bridges have three principal origins. These are described below and illustrated in Figure B1.

Shallow crustal earthquakes originate at a depth of less than 12 miles and are generated within the different seismotectonic provinces in the overlying North American Plate (e.g., Mw 5.7 Scott Mills earthquake on March 25, 1993).

Deep intraplate earthquakes originate at a depth of 25–45 miles and are the result of internal stresses associated with the bending and arching of the Juan de Fuca plate as it is subducted beneath the North American plate (e.g., Mw 6.8 Nisqually earthquake on February 28, 2001).

Subduction zone interplate thrust earthquakes are very large earthquakes originating at the boundary between the North American and Juan de Fuca plates (e.g., Mw 9.0 earthquake on January 26, 1700).

Source	Magnitude	Frequency	Latest Occurrence
Crustal	M<5.5	Every 15 – 20/yr	Annually
	M≥5.5	Unknown	1993: Scotts Mills & Klamath Falls
CSZ*	M ≥ 8.0	Every 350–500 yrs	Jan., 1700
Intraplate	M = 4.0–7.0	Every 30–50 yrs	Feb., 2009: M4.1, Grants Pass, OR

* Cascadia Subduction Zone Interplate event

Table B1: Oregon seismic activity. The table provides a brief summary of the primary earthquake sources affecting Oregon, including the approximate frequency of occurrence, range of magnitude, and most recent activity.

Large Magnitude Earthquakes along the Cascadia Subduction Zone

Geologists have indicated in recent years that the question is not if a catastrophic earthquake will occur in Oregon, but when it will occur. Evidence indicates that Cascadia Subduction Zone earthquakes of magnitude 9.0 or greater have occurred on average about every 400–600 years, most recently in late January of 1700 A.D.¹ More recent research by the Oregon Department of Geology and Mineral Industries indicates that subduction zone earthquakes could actually occur on average every 300–350 years, and there is a 37 percent chance that a powerful earthquake (magnitude 8.0 or greater) will occur along the southern Oregon coast in the next 50 years.² This type of earthquake would include several minutes of severe ground shaking, large tsunamis, and extensive damage to state and local infrastructure, buildings, utilities, and other facilities.

The tectonic and subduction zone conditions off the Oregon coast are strikingly similar to those off the east coast of Japan. There, the Japan Trench subduction zone

¹ The Pacific Northwest Seismic Network, USGS. (2008). Earthquake Hazards in Washington and Oregon: Three Source Zones. Retrieved from: <http://www.ess.washington.edu/SEIS/PNSN/> (last updated 8/28/2008).

² Tobias, L. (2009, April 19). Big earthquake coming sooner than we thought, Oregon geologist says. *The Oregonian*. Retrieved from: http://oregonlive.com/news/index.ssf/2009/04/big_earthquake_coming_sooner_t.html

produced the Great East Japan Earthquake of March 11, 2011.³ This magnitude 9.0 earthquake was the fourth largest ever recorded. Damage was documented over a very large area, and the total economic loss in Japan is estimated at \$309 billion U.S. dollars.⁴ Reconstruction is expected to take at least 10 years and will cost an estimated \$279 billion U.S. dollars.⁵

Damage to Oregon's infrastructure from a similar Cascadia Subduction Zone event will be extensive. The intense ground shaking will trigger soil liquefaction in many areas, resulting in embankment and cutslope failures along large portions of lifeline corridors. Oregon bridge sites are also vulnerable to damage because of the state's topography and geology. Soil profiles at many bridge sites are prone to liquefaction during strong earthquake shaking. Depending on the location of the epicenter of the earthquake, areas receiving major damage from a subduction zone earthquake of magnitude 8.0–9.0 could include most of the counties in western Oregon, including heavily populated metropolitan areas such as Portland, Salem, and Eugene.

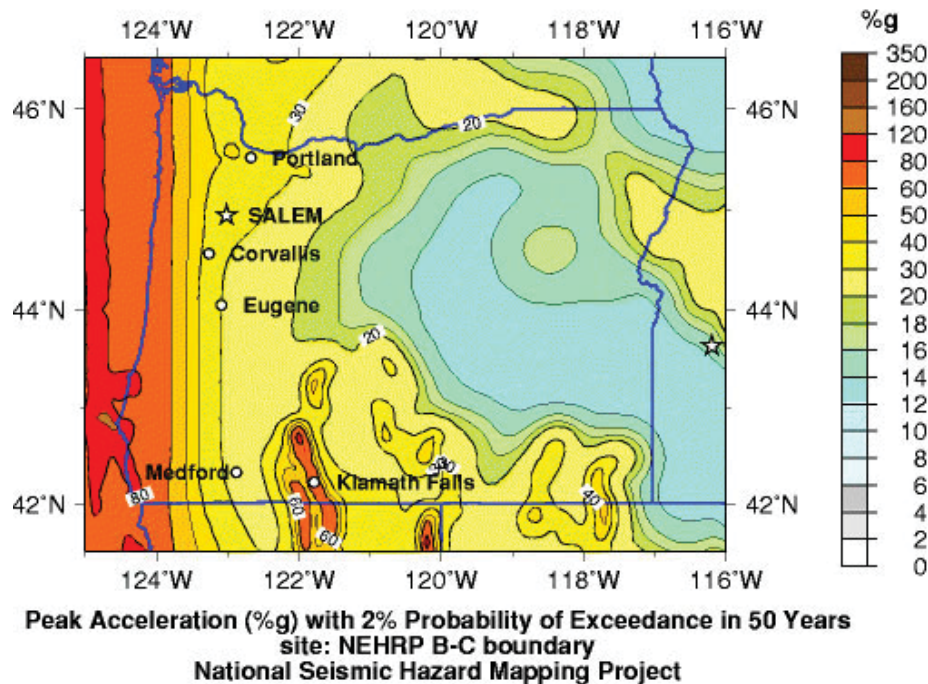

Figure B2: U.S. Geological Survey seismic hazard map showing peak bedrock horizontal acceleration with 2% probability of exceedance in 50 years. This map best represents Oregon's seismic hazard and is the map currently used by the Oregon Department of Transportation (ODOT) for the seismic design of bridges. Note that the coast and most of the western portion of Oregon are in a relatively high seismic hazard area, primarily due to the presence of the Cascadia Subduction Zone. Source: USGS 2002 Seismic Hazard Map

³ Oregon Department of Geology and Mineral Industries (DOGAMI). (2012, Winter) *Cascadia*. Portland, OR.

⁴ U.S. Geological Survey. (2012). *Magnitude 9.0 Near the East Coast of Honshu, Japan, March 11: Earthquake Summary*. Retrieved from: <http://earthquake.usgs.gov/earthquakes/eqinthenews/2011/usc0001xgp/#summary>

⁵ Government of Japan: Ministry of Economy, Trade and Industry, National Policy Unit. (2012, March). *Road to Recovery*. Retrieved from: http://www.kantei.go.jp/foreign/policy/documents/2012/_icsFiles/afieldfile/2012/03/07/road_to_recovery.pdf

ANTICIPATING THE IMPACTS OF A CASCADIA EARTHQUAKE

The combination of very strong and prolonged ground shaking, followed closely by a powerful and damaging tsunami, makes a Cascadia Subduction Zone earthquake the most dangerous natural hazard for the entire state of Oregon, but especially for Oregon coastal cities. The ground shaking will destroy buildings and roads, down power lines, block streets, and rupture gas lines, which in turn will cause explosions and fires, broken water and sewer lines, and a largely uninhabitable environment in many areas.

Because Oregon has never witnessed a disaster of this magnitude in modern history, we can only speculate about the impact this event will have on Oregonians. Unlike other crises, such as a highway crash or a house fire, where a few fire trucks and ambulances arrive within minutes to rescue people in need, the situation after a Cascadia Subduction Zone earthquake will involve disruptions of emergency services along with everything else. There will not be enough firefighters to assist every single household or business. There will not be enough medical staff to help every injured person. There will not be a police officer at every doorstep to remind people to be calm and quickly move to higher ground to avoid the oncoming tsunami. So, what would happen after a major subduction zone earthquake? The earthquake and tsunami in Japan on March 11, 2011, offer us some insight (Figure B3).



Figure B3 : Before and after earthquake and tsunami in Japan; Source: cbsnews.com

Loss of Mobility after a Major Earthquake: Bridges

To better understand the likely effects of a large earthquake on transportation in Oregon, ODOT and Portland State University undertook a two-year assessment of the vulnerability of the state's bridges.⁶ The results offer a vivid picture of the loss of mobility that a subduction zone earthquake is likely to cause, given the current state of the infrastructure.

Coastal Area Impacts

Assuming most of our citizens have a basic understanding of the effects of a subduction earthquake, it is reasonable to expect a massive movement of people away from the coast. Acknowledging that no immediate help will be available, many people will try to drive away from shore and out of reach of the tsunami—but is our transportation network ready to handle this huge, confused and panicked traffic? As of now, unfortunately, the answer is “No.” Coastal residents have been coached to get away from the shore on foot, but tourists and commercial travelers are not likely to know that.

For most Oregon coastal cities, U.S. 101 is the main route out to other destinations. Unfortunately, after a Cascadia Subduction Zone earthquake, most of this route will be impassable. Most bridges carrying U.S. 101 were not designed for any seismic loading and will collapse under the expected ground shaking. Many other bridges, if they survive the shaking itself, will be washed away by the tsunami. In addition to the bridge damage, many highway segments are expected to be heavily damaged and impassible due to landslides. The latest assessment of state-owned bridges shows that of the 135 bridges carrying U.S. 101, 56 are expected to collapse entirely and 42 will be heavily damaged. Some of these bridges are signature bridges and are registered as historic.

East-West Corridor Impacts

East-West corridors between the coast and the Willamette Valley are the next tier of alternatives for people escaping from the disaster zone and for emergency crews responding to the impacted areas. However, the bridges on these corridors are also vulnerable to ground shaking, landslides, and liquefaction of supporting soils, so it is likely that these segments will not all be passable. The overall condition of bridges on these routes is moderately better than those carrying U.S. 101; nevertheless, many “weak links” exist along these routes that will make them impassable as well.

Because of the terrain that these highways were built on, many lack detour options around bridges that collapse. The situation could become even more critical if the earthquake strikes during winter, when many of the state's secondary routes experience seasonal closure. Table B2 shows the results of an inventory and damage assessment for state bridges located along the major routes connecting U.S. 101 to Interstate 5. The assessment assumes that the bridges were subjected to a Cascadia Subduction Zone event.

⁶ Nako, A., Shike, C., Six, J., Johnson, B., Dusicka, P., & Selamawit, M. (2009, November). *Seismic Vulnerability of Oregon State Highway Bridges: Mitigation Strategies to Reduce Major Mobility Risks*. Salem, OR: Oregon Department of Transportation, Bridge Engineering Section.

Route	Total No. of Bridges	Bridges Collapsed	Heavily Damaged
U.S. 30 (Hwy 92)	27	6	3
U.S. 26 (Hwy 47)	52	3	10
OR 99W & OR 18 (Hwy 91 & Hwy 39)	35	5	4
OR 34 & U.S. 20 (Hwy 210 & Hwy 33)	42	7	3
OR 569 & OR 126 (Hwy 62 & Hwy 69)	50	9	9
OR 38 (Hwy 45)	19	1	3
OR 42 (Hwy 35)	47	23	5

Table B2: Vulnerability of East-West corridor bridges to a Cascadia Subduction Zone earthquake.

Interstate 5 and Mid-Willamette Valley Impacts

Interstate 5 (I-5) will also have some major problems after a Cascadia Subduction Zone earthquake. With the majority of bridges on I-5 built just before modern seismic design specifications were developed, the most important segment of Oregon's transportation network may become fragmented after the earthquake, with some areas not operational (depending upon the quake's intensity and epicenter). During the latest Oregon Transportation Investment Act (OTIA) program, ODOT was able to replace some deficient structures along this route; however, the main criterion for the selection of these bridges was the need to support current truck load requirements and not necessarily to meet current seismic bridge standards. Thus, several bridges that have already been identified as vulnerable to earthquake shaking are still in active service. From a total of 348 bridges carrying both northbound and southbound traffic, five bridges are expected to collapse and 19 bridges to be heavily damaged after a Cascadia Subduction Zone earthquake.

Because of its location and capacity, and because U.S. 101 is expected to be impassable, I-5 will become the critical backbone route for emergency response after the earthquake. To the extent that I-5 is operable, emergency support can be staged along the corridor, and responders will be able to reach the coastal cities through the East-West corridors (once these corridors become accessible) or by other means.

Interstate 5 becomes an even more important route during the statewide recovery effort. Many scientists believe that the next Cascadia Subduction Zone earthquake will be a mirror image of the 2011 Tohoku earthquake that hit Japan. This means that most of our coastal cities will be heavily damaged, and restoring their previous living environment will not be an easy task. In addition to large numbers of damaged buildings, many ports and airports in these cities will be heavily damaged and most likely will not be operational for some time after the earthquake. This puts more emphasis on the need for a resilient transportation network for the state of Oregon. Anticipating that help for the impacted coastal areas will come initially from the cities along I-5, and later from the rest of the state and entire northwest region, it makes sense to select I-5 as the most vital route for the post earthquake recovery.

Central Oregon U.S. 97 and Highways through the Cascades

In the event that Interstate 5 is not operational, particularly in areas without viable detours, U.S. 97 will be a critical facility for ongoing interstate commerce and for staging response and recovery efforts. Redmond Municipal Airport is a staging site for federal emergency response in Oregon. East-West corridors through the Cascades connect to more vulnerable parts of the state and are therefore a necessary part of the response and recovery system. Because there is far less likelihood of damage to facilities in these areas, they will be relied upon extensively after a Cascadia Subduction Zone event.

Loss of Mobility after a Major Earthquake: Landslides & Rockfalls

Slope failures are as common to earthquakes as structural collapse, liquefaction, and ground deformation. Strong ground shaking from a Cascadia Subduction Zone earthquake will trigger countless new slope failures and activate existing landslides. Reactivation of the known landslides alone will be catastrophic during the ensuing seismic emergency. Additional failure of weak slopes and embankments or reactivation of previously unknown landslides will further compound the disaster. Not only will landslides occur during and soon after the earthquake, but the strong ground motion will also affect other landslides and slopes, which will become even more prone to failure in the ensuing months. Land-slides will continue to impede rescue and relief efforts long after the shaking has stopped.

Landslides are one of the most significant secondary effects of earthquakes and, in areas that are susceptible to landslides, one of the leading immediate causes of death worldwide (apart from the earthquake itself). Currently, there are about 1,700 known landslides that directly affect the highway system between the Willamette Valley and the Oregon coast. Undoubtedly, western Oregon will be overwhelmed by the landslides that accompany a subduction zone earthquake. Landslides will affect all phases of the disaster and result in:

- Immediate injury or loss of life during the seismic event. For example:
 - ◉ Motorists may be struck by rockfall or landslides/slide debris.
 - ◉ Motorists may strike materials in the roadway.
 - ◉ Motorists may drive into collapsed roadways.
 - ◉ Motorists may be pushed off the roadway by landslides.
 - ◉ Vehicles or persons may be buried under slide debris.
- Immediate damage to the transportation infrastructure due to:
 - ◉ Numerous small- to average-sized landslides.
 - ◉ Very large landslides.
 - ◉ Impediments to tsunami evacuation.
 - ◉ Obstructions to rescue and evacuation efforts.
- Hindrance to recovery in immediate aftermath and long-term economic recovery.
 - ◉ Long-term highway closures due to landslides.
 - ◉ Ongoing landslides from weakened slopes.
 - ◉ Disruption to utilities that share highway right-of-way.

- ⦿ Long-term mitigation of very large landslides, which will impede repair of bridges and other facilities.
- ⦿ Massive consumption and shortages of fuel and other material resources used in landslide repair work.

Steep slopes, weak soil and rock, heavy rainfall, and high groundwater are all conditions that lead to slope failure and are widespread throughout the state, particularly in the western half. Almost every highway in western Oregon is affected in some way by landslides. Where these conditions exist, slopes are at a much higher risk of failure during an earthquake. The greatest hazards, however, are the existing known landslides and the existing slides that are yet to be discovered. Recent research by the U.S. Geological Survey has shown that seismogenic landslides—that is, new slides initiated by earthquakes—tend to move a few inches to a few feet, while existing slides reactivated by earthquakes are more likely to move several yards. Highways traversing mountainous terrain will be the most disrupted, but routes in low-lying areas such as the Willamette Valley will also be affected by liquefaction and lateral spreading, which can cause otherwise stable embankments and fills to fail.

Coastal Area Impacts from Landslides and Rockfalls

As most residents of coastal Oregon know, U.S. 101 experiences numerous service disruptions every year due to active landslides and rockfalls. It is a challenge for the agency just to keep this route functioning during normal winter weather. Given the large number of unstable slopes in the area, the potential effects on this route of strong ground shaking and tsunami waves from a Cascadia Subduction Zone earthquake are almost unimaginable.

There are currently 526 known unstable slopes that directly affect U.S. 101. Many of these slides will fail catastrophically during the earthquake, while others will fail during or soon after the tsunami. Slopes that do not immediately fail during the seismic event will be destabilized to varying degrees and may fail either soon after or at some time during the rescue and recovery efforts. Not only will coastal residents have to contend with the primary effects of the earthquake, but their evacuation, rescue, and recovery will be further hindered by landslides and rockfalls. Their escape from the tsunami may be blocked by failed slopes, and many could also become landslide victims.

East-West Corridor Impacts from Landslides and Rockfalls

The East-West routes connecting U.S. 101 to Interstate 5 are only marginally better than U.S. 101 itself with respect to landslides and rockfalls. These routes traverse very steep terrain that is underlain by generally weak materials. In addition, the Oregon Coast Range experiences very high rainfall each year that further serves to weaken slopes and embankments. A high number of landslides occur in this area on an annual basis, and a very high number should be expected during a Cascadia Subduction Zone earthquake solely on the basis of the geologic conditions.

What makes these routes particularly vulnerable is the presence of very large, existing landslides along them. These old slides are expected to have the highest amounts of displacement during an earthquake. A whole mountainside can move tens of meters vertically and horizontally, taking the entire roadway with it.

Such landslides have the capacity to close roads for several weeks while efforts are made to reconstruct the roadway or build a detour around the slide.

Recent LiDAR technology, where available, has led to the discovery of many of these large, sometimes ancient, landslides. In some cases, the slides were previously known, as they have had some effect on the highway in the past. In other cases, it has been shown that highways traverse enormous landslide features that were not previously known to exist and that have been inactive since their initial failure. It has been theorized that many of the known, large, ancient landslides in the Oregon Coast Range and the Columbia River Gorge are the result of past Cascadia Subduction Zone earthquakes.

Interstate 5 and Mid-Willamette Valley Impacts from Landslides and Rockfalls

Interstate 5 and other highways in the Willamette Valley are not without their own landslide and rockfall vulnerabilities. Many fills and embankments were either constructed of or on liquefiable soils in high groundwater areas, making them particularly susceptible to earthquakes. Interstate 5 also traverses mountainous terrain in the southern part of the state, and unfavorable geology contributes to ongoing slope instability along I-5 in the Portland area.

In all, there are 49 known landslide and rockfall areas along Interstate 5. Other unstable areas are suspected. In the event of a Cascadia Subduction Zone earthquake, the most important route in the state will not be without landslide and rockfall problems. Many of the slides through the Willamette Valley are minor and can be readily mitigated. Most of the slides in the Portland area have been treated, but there are some examples that could result in lengthy repairs and service disruption. For the Portland area, adequate detours exist in areas that are not as vulnerable to landslides, but delays will occur. The greatest concern for this route is the mountainous areas of southern Oregon. Unfavorable geology (in terms of geologic structure, materials, and groundwater) has formed some very large, complex landslides in this area. These slides have the capacity to cut this route off at the southern end for many weeks while repairs take place or detours are constructed.

Restoring Highway Continuity after the Earthquake: Bridges

Rebuilding a bridge under normal conditions is usually a routine operation for planners, engineers, and construction companies. Data from previous projects that are similar in scope provide the information needed to estimate the cost and time for constructing new projects. Designers and builders usually have a clearly defined approach when it comes to construction methodologies and techniques for building certain types of bridges. Depending on the size and location of a project, it may take as little as a year or two to construct small bridges on routes with low Average Daily Traffic (ADT), and up to more than a decade to construct big projects on busy routes.

By contrast, facing a post-earthquake situation with tens or even hundreds of bridges in need of immediate replacement will be very challenging. Every single step of the process to replace these structures will encounter new circumstances and involve many unknown factors, which usually determine the cost and timeframe for building a bridge.

Some of the questions that need to be answered are:

- What is the capacity of the bridge engineering community for designing replacement bridges or repairs in an emergency situation?
- What contractors will be available to construct this many bridges?
- Will we have adequate construction materials to supply these projects?
- Realizing there will be many other structures in need of repair or replacement at the same time, what reconstruction has the first priority?

It is well understood how difficult it will be for the state to recover economically after a Cascadia Subduction Zone earthquake if several bridges along the state's most critical routes collapse or suffer major damage. Having multiple impassable bridges within a given highway corridor poses a big problem for the bridge building industry as well. After the earthquake, many bridge sites will be very difficult to access or will not be accessible at all to normal construction equipment. Restricted access will prevent or delay the repair or reconstruction of many bridges. The process of rebuilding our bridges and thus rebuilding the state's transportation network will follow the corridor approach, sequentially opening longer sections of connected highways identified as priority lifeline routes.

Repairing or replacing many damaged bridges along Interstate 5 after an earthquake will take varying amounts of time depending on which structures are damaged and the type of damage. While the access to bridge sites will likely be more direct along Interstate 5 (compared to other routes), the design and construction process will not be an easy task due to demands on resources and the need to respond to widespread damage. Mainline bridges, especially those over large rivers, will be more problematic than the roadway overpasses. The size of the majority of bridges crossing waterways along I-5 is significant (see Figure B4). The design effort for one of them will take several months for a permanent crossing. Additionally, construction of bridges of this size has typically taken multiple years to complete. That time could be reduced under emergency conditions, especially if traffic is diverted and the contractor has unlimited use of the site.

Normally, the replacement structure will be larger and designed to higher standards than the one it replaces. This has usually been achieved by using precast elements and heavy weight machinery. It is unknown how well the precast yards will be able to handle the large demand for their products or whether there will be enough excavators and cranes to cover the statewide need for them. The temporary bridges owned by the state and those possibly available for loan or purchase will not span the distances needed for crossing our larger rivers.



Figure B4: North Umpqua River (Winchester) Bridge, one of the state's many large bridge structures. The repair or replacement of such bridges after a subduction zone earthquake will be both challenging and time-consuming.

Fortunately, many of the larger mainline bridges on I-5 have received at least a Phase 1 seismic retrofit. In order to have the desired level of resiliency, however, they will need to be strengthened with a Phase 2 seismic retrofit.

Reconstruction of smaller bridges will also not be immediate, even under emergency procedures, especially around the larger metropolitan areas like Portland. Many of these “simple” structures cross local streets, and the presence of traffic on these streets can significantly delay reconstruction.

Overpasses on I-5 have not been retrofitted to any level and are therefore likely not only to be damaged beyond use, but to block access along the mainline. Emergency removal of the debris may restore temporary access along the mainline, but access to intersecting routes will take much longer. While it is known that most of these medium-sized bridges across the state’s main routes are seismically vulnerable, planning to retrofit them is unrealistic given current economic constraints. Even though many will be impassable after the earthquake, we believe they will have minimal impact on the traffic on these routes themselves. On the other hand, reconstruction of these overpasses will have a significant impact on the main routes. There is not an easy way to build a bridge over a busy highway and inside a busy metropolitan area. Most of these bridges are multi-span structures and usually contain an interior bent between traffic lanes. Repairing or rebuilding these bridges will be very difficult without significant traffic disruption (see Figure B5).

The situation is even worse for replacing damaged bridges on routes connecting I-5 to the coastal cities. While the design process for many of these bridges can start at the same time (assuming enough structural engineers are available), constructing them will depend on their accessibility. Access to bridge sites will be very difficult and almost impossible for most areas, because there are few detours available. In areas where each bridge must be dealt with consecutively, the time for complete corridor restoration would be multiplied.



Figure B5: SW 4th Avenue over Interstate 405. Overpasses such as this may collapse during a large earthquake and will be difficult to repair or replace without further disruption of I-5 traffic.

Rebuilding U.S. 101 along the coast after a Cascadia Subduction Zone earthquake will most likely require a national mobilization. There will not be any significant local workforce or contractors available, and local suppliers may not be operational for a period of time after a catastrophic event. Access to a few bridge sites may be accomplished from waterways, but the majority of structures along this corridor will be hard to reach. The timeline to rebuild the entire U.S. 101 route after a Cascadia Subduction Zone earthquake will depend on the magnitude of the overall damage to roadways.

Restoring Highway Continuity: Landslides and Rockfalls

Restoring a section of highway after a landslide or rockfall can be a complex and often risky undertaking. Additional unstable areas may remain, information about the subsurface conditions leading to or still influencing the event are unknown, and the overall scope of the project can be uncertain. Although slide and rockfall restoration and mitigation work is never a routine task, in Oregon, it is a common activity. Fortunately, many geologists, engineers, and contractors in this area are familiar with this type of work, and reconstruction and mitigation procedures are now well established and can usually be adapted to common earthwork practices.

Many variables play into the mitigation or restoration of landslides and rockfalls. A slide's location, size, and composition, along with the weather, all affect the timeframe and cost of a repair. Unlike bridges and other structures, landslides are not made of a known quantity of materials with known properties. Each site is different and may differ substantially from a site that is nearby. Determining the cost and construction time for landslide mitigation usually takes several months and involves subsurface exploration, intense ground survey, material testing, and instrumentation and monitoring. Emergency restoration of certain types of slides, such as small rockfalls, may take only hours. Repairing a highway after a major landslide where continuing instability exists can take several months. Considerable agency experience with unstable slopes allows for a reasonably precise estimation of the time it would take to mitigate majority of seismogenic slides that could affect the transportation system.

The effects of a subduction zone earthquake, in which hundreds or even thousands of landslides of all types and sizes will need to be addressed, could be overwhelming. Each site will be different in many ways, and there will be no time to assess each site for the most cost-effective solution. Some of the most important issues to be considered are:

- With so many slides affecting the highway, how will these be prioritized for repair so that other features, such as bridges, can also be addressed?
- How long will it take to restore the routes to a level of service that can accommodate emergency vehicles? How long to restore routes to withstand the transportation of freight and construction materials?
- How many contractors and personnel and how much equipment will be available for slide restoration?
- How many geotechnical professionals will be available to assist with slide assessment and repair design?
- Will there be enough material available for slide repair? Will sources be accessible?



Figure B6: Hwy38 Rockfall site not previously known to be unstable

Restoring the roadways after a Cascadia Subduction Zone event will also depend on the nature of the slides that affect them. Naturally, the larger the slide, the longer and more costly the repair will be, but there are many other variables that will come into play. Typically, rockfalls or landslides that occur on slopes above the roadway would be the least disruptive. It should be only a matter of removing the debris from the roadway and disposing of it elsewhere. Often, however, a very large amount of material completely buries the roadway—or very massive materials block it—and specialized equipment, materials, and personnel are needed to remove these obstructions (Figure B6). There may also be an unstable condition remaining that requires additional work before any type of traffic is allowed to resume. A worst-case scenario in this regard would be for emergency personnel to become victims themselves by being struck or entrapped by continuing slide movements.

The types of landslide associated with the greatest delay time are those that involve a complete failure of the roadway. Slides that entirely displace the roadway prism require the greatest effort to restore. This is because the failed material must be removed or stabilized before reconstruction of the roadway can begin. These types of slides in mountainous terrain are the most difficult, because access to the site is extremely challenging. An additional hazard is that this type of slide can be worsened by incorrect construction procedures. The project must therefore be evaluated both ahead of time and throughout construction.

Landslides and rockfalls can often be conditionally restored for emergency or even construction use in a short amount of time, but there are tradeoffs that may or may not be acceptable in a given situation. For example, when materials block the roadway, equipment may be used to clear a lane for emergency vehicle use, but this quick solution may not be acceptable if a large mass of unstable rock remains where it could fall onto the roadway. In a case where the roadway has been completely displaced, it may be possible to re-level the surface with just a few truckloads of material or build ramps in and out of a wide site, or it may be possible to construct a temporary detour if the terrain is favorable (Figure B7).



Figure B7: Two examples of temporary slide bypasses

In some cases, the slides will be of such magnitude that other established routes will be needed to serve as detours until a complete reconstruction of the roadway can be completed. This type of failure is expected from existing large slides and from large embankments constructed on liquefiable foundations. Figure B8 is an example of a site that took 21 days to restore to full service; it took one day to construct a bypass for emergency vehicles.



Figure B8: Complete roadway failure on U.S. 30 east of Clatskanie, 1996. Note the section of undermined pavement

Access to the failed sections of roadway will be the most significant factor affecting the overall time that it will take to restore the system. A coherent approach to prioritizing sites for repair will be entirely dependent on how many of the sites will be accessible at a time. A strategy will need to be developed for bypassing certain sites, temporarily restoring others, and focusing efforts on a select group, in order to ensure that as many resources as possible can be utilized concurrently. This approach would dramatically reduce the time it will take to bring the priority corridors back online. In areas where each slide must be dealt with consecutively, the time for complete corridor restoration would be multiplied. A comprehensive plan for the deployment of personnel and equipment and for the distribution of materials is essential for restoring service and recovering from the disaster.

WHAT CAN BE DONE TO IMPROVE STATEWIDE RESILIENCE

Given the seriousness of Oregon's earthquake hazard and the likely short- and long-term impact of a Cascadia Subduction Zone earthquake, it is prudent to take steps now to mitigate this risk to our homes, businesses, communities, and economy. As the following discussion shows, some of the necessary groundwork has already been done, including assessment of the transportation system's vulnerabilities and identification of ways that those vulnerabilities can be addressed and reduced.

The Seismic Vulnerability of Oregon State Highway Bridges Report

In 2009, ODOT published a report that identified major mobility risks from earthquakes and recommended possible mitigation strategies. The culmination of two years of study jointly conducted by ODOT and Portland State University, it describes potential damage from six representative earthquake scenarios that are thought most likely to occur in Oregon.

As described in the previous section, the study found that highway mobility would be severely reduced after a major Cascadia Subduction Zone event, as well as after a significant crustal earthquake. U.S. 101 would have dozens of failures and would be impassable due to bridge collapses. All of the existing highways that connect U.S. 101 to I-5 would be impassable due to bridge collapse, landslides, and other damage. Small segments of I-5 would be useable, because a number of those bridges have been replaced since 1990 (including many in the OTIA III Program); but many older, obsolete overpasses would collapse and block the through lanes, and many older river crossings would be impassable. Some essential services that depend on the Willamette River crossings in Portland would also be affected.

The report also considers possible mitigation, including bridge retrofit and strengthening to withstand seismic damage. It concludes with seven recommendations. Three are related to finding ways to include seismic retrofitting projects in the Statewide Transportation Improvement Program (STIP) in the face of current funding constraints. The remaining four are as follows:

- Refine the recommendations by working with stakeholders to define the highest priority and most cost effective mitigation strategies and routes.
- Communicate and educate stakeholders and highway users on potential damage and options for mitigation.
- Update the previous lifeline route designations.
- Work with stakeholders to define a long-term comprehensive study of seismic vulnerability and risk for the entire transportation system.

Passage of House Resolution 3

In April 2011, the Oregon House of Representatives unanimously passed House Resolution 3 (sponsored by Rep. Deborah Boone, D-Cannon Beach). It directs the Oregon Seismic Safety Policy Advisory Commission to "lead and coordinate preparation of an Oregon Resilience Plan that makes recommendations on policy

direction to protect lives and keep commerce flowing during and after a Cascadia (megathrust) earthquake and tsunami.” The plan and recommendations were delivered to the Oregon Legislative Assembly by February 28, 2013. The resolution acknowledges the emerging knowledge of seismic hazards in Oregon by members of the legislature and Oregon citizens. ODOT led the effort to prepare input to the plan related to transportation infrastructure.

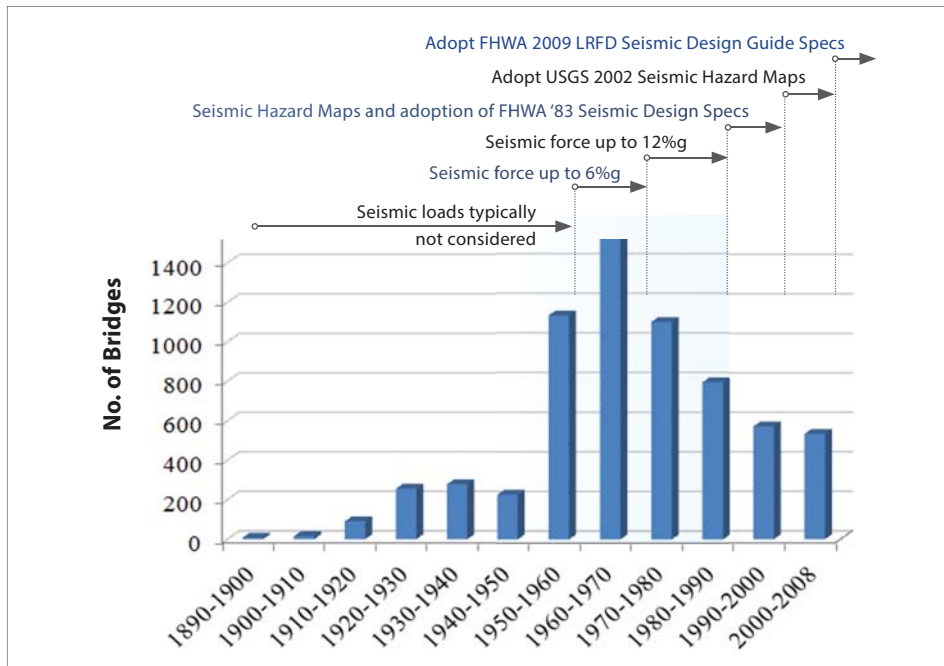

Figure B9: History of the seismic design of Oregon's bridges

Retrofitting Progress

Years	Actions	# Bridges
1994, 1997	Ch2MHill prioritization studies identify vulnerable bridges (only state bridges are included in total shown)	1155
1985 through 2012	Phase 1 retrofit added to repair contracts in STIP Other bridges resolved (replacements or retrofits added to repair/widening contracts in the STIP & OTIA III Program)	143 212
Total number of bridges addressed		355
Future	Bridges still needing retrofitting (About 200 years at average 4 bridges retrofitted per year in the STIP, much longer for Phase 2 and much longer due to OTIA III bond payback)	800

Table B3: Status of bridge retrofitting through 2012

Vulnerabilities and Mitigation: Retrofitting Bridges

The post-earthquake reconnaissance reports of some of the most significant earthquakes worldwide have identified various bridge failure modes. Each failure mode can impact traffic and life safety differently, depending on the damage level of various bridge components. Minor structural damage, such as concrete spalling or minor approach settlement, can be easily repaired and does not pose any significant threat to traffic. However, the situation can become overwhelming when bridge columns experience significant damage, the bridge superstructure falls off, or the entire bridge collapses.

Minor structural damage is either the result of an earthquake that was smaller than the design earthquake, or an indication that the bridge was intentionally designed for a higher damage level, based on cost considerations. Heavier damage than expected can occur on bridges that were either designed for smaller earthquakes or have not been designed for seismic loads at all (most Oregon bridges—see Figure B9 and Table B3).

Acknowledging the fact that many bridges across our nation were built well before the seismic design specifications were available, the bridge design community has developed retrofit details to make these bridges seismically resilient. Because they have a good understanding of how a bridge will behave under a given earthquake motion, bridge engineers are now able to identify the vulnerable elements of a bridge and retrofit those accordingly. The Federal Highway Administration (FHWA) has been working intensively with many transportation departments to identify the appropriate retrofit details and methods for vulnerable bridges. The recommended details and bridge seismic retrofit guidelines were published in the 2006 Seismic Retrofit Manual for Highway Structures.

A preliminary assessment has found that Oregon bridges have seismic vulnerabilities similar to those of bridges damaged in previous earthquakes, deficiencies such as insufficient column reinforcement, insufficient foundation capacity, non-stable bearings, inadequate superstructure seat width, and presence of liquefiable soils. ODOT adopted the 2006 FHWA Retrofit Manual in April 2010. After an evaluation process, some of the details included in this manual (Figures B10 – B13) have been selected as good solutions for retrofitting Oregon bridges. Because of our state's unique seismic situation, ODOT is currently evaluating the performance of these retrofit details under a very strong and very long shaking event, such as a M9.0 Cascadia Subduction Zone earthquake. This evaluation process is not expected to invent new retrofit details, but it should identify any need to refine the existing ones.

The vulnerabilities of Oregon bridges are complex and differ from bridge to bridge and from site to site. Some bridges are prone to more than one type of seismic deficiency, and a few may need to be replaced. ODOT has already conducted research and investigation to develop the best approach for mitigating the problem. Worldwide experience has shown that while we are not knowledgeable enough to predict the exact time that an earthquake will strike, we can be proactive to save lives and speed up the recovery process. The following figures illustrate common seismic damage and recommended methods of mitigation or retrofitting for bridges. (See the detailed description of retrofitting methods in Appendix F.)

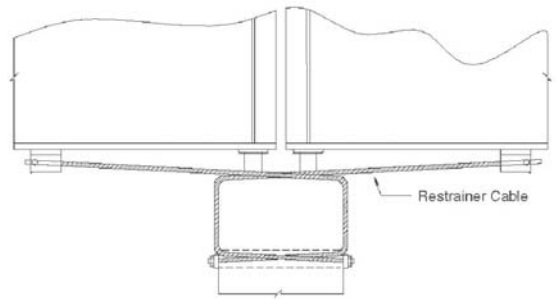

Figure B10: Restrainer Cables will prevent the bridge superstructure fall-off

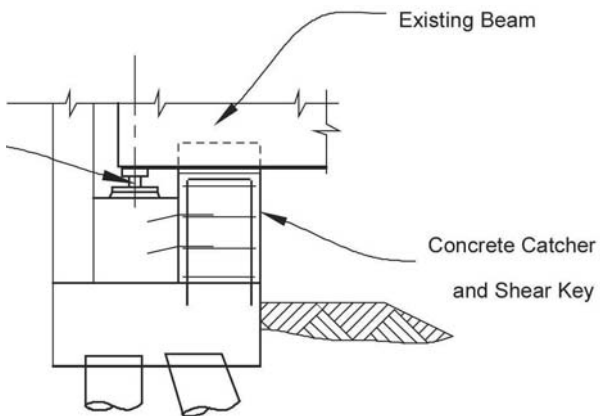
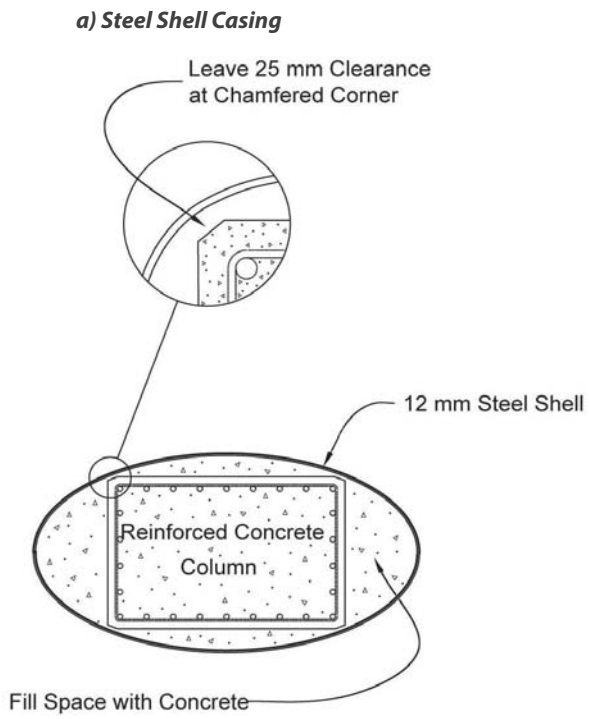

Figure B11: Shear Keys restrain the superstructure transversally during an earthquake, preventing damage



b) Isolation Bearings

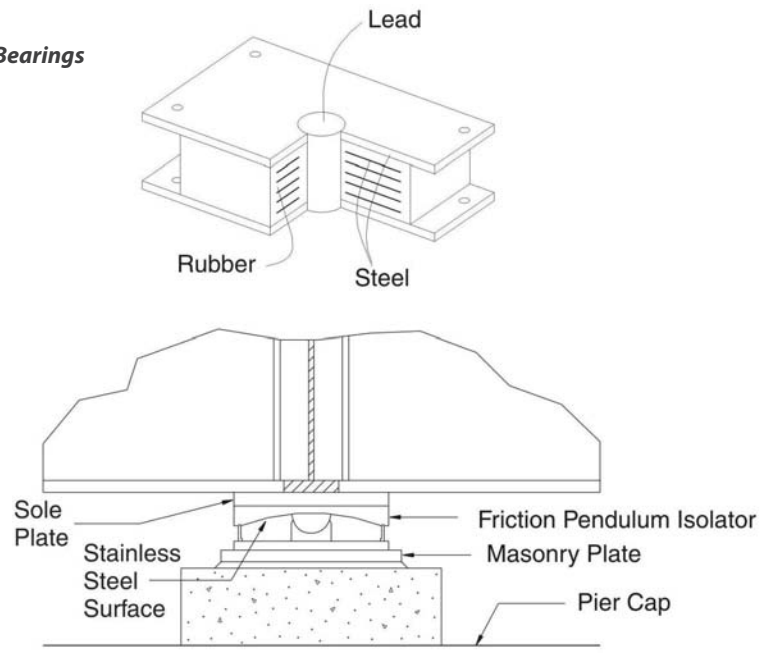
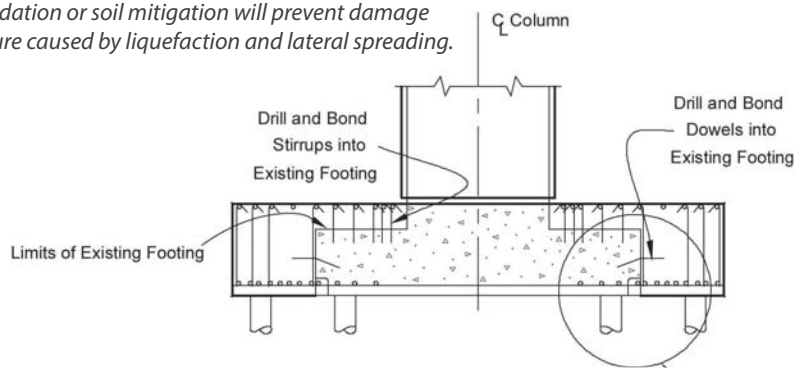

Figure B12: Preventing damage to the column by:
 (a) steel shell casing.
 (b) isolation bearings.



Figure B13: Strengthening the foundation or soil mitigation will prevent damage to the bridge substructure caused by liquefaction and lateral spreading.



Vulnerabilities and Mitigation – Landslides

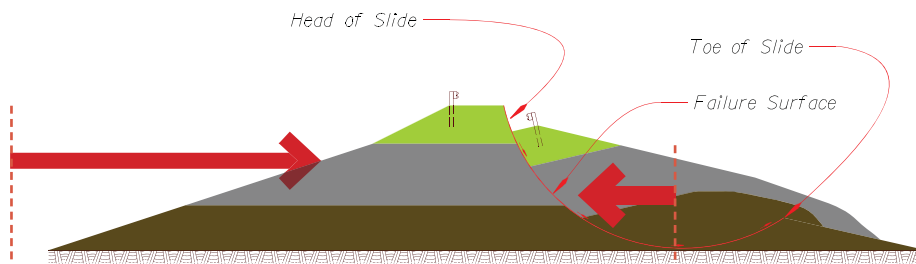

Driving Force:

- Forces that cause sliding
- Mass of soil/rock at the head of the slide
 - Water in the slide
 - Seismic forces (ground shaking)
 - Structures and traffic load
 - Steep slopes

Resisting Force:

- Forces that prevent or resist sliding
- Mass of soil/rock at the toe of the slide
 - Soil/rock strength
 - Retaining structures
 - Flatter slopes

Factors that **DECREASE** resistance to sliding:

- Water
- Seismic forces (ground shaking, liquefaction dilation)

Figure B14: Design approach for slide mitigation.

Structural mitigation of landslides is usually the most costly, yet effective, approach to slide mitigation. Structural mitigations are selected for high-risk applications:

- where the chance of failure during construction while using other methods is high,
- where adjacent facilities or structures need to be protected,
- when the environmental impacts of other methods are too high,
- where other methods simply will not work.

Construct Retaining Wall (Increase Resisting Force)

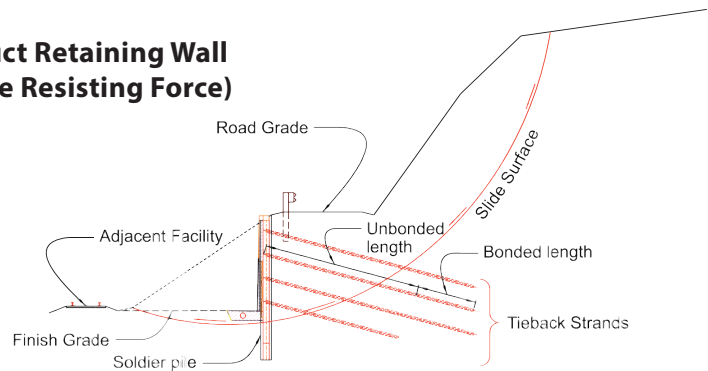

Figure B15: Tieback soldier pile walls, as shown here, are one of the most effective, lowest-risk approaches to slide mitigation. A series of relatively large-diameter columns are drilled through the slide and deep into resistant material below the slide. The columns usually consist of strong H-piles and reinforced concrete to resist the shear forces of the landslide. As strong as they are, these columns are not usually sufficient on their own to stop a landslide. They usually require the added strength of ground anchors (tiebacks). Once the columns are in place, excavation of "lifts" in front of the wall begins so that the tiebacks can be installed. These lifts are the top 8–10 feet of material in front of the wall. A single row of tiebacks is installed at the column location for each lift excavated. For the tiebacks, a drill rig bores a hole at an angle down through the slide and into hard, resistant material below the slide surface.



A high tensile strength steel strand or cable is inserted into the hole and grouted into place below the slide surface. Once this grout hardens, the cable or strand is tensioned to the designed load to hold back the slide and then locked off at the column to hold the tension. Shotcrete or cast-in-place concrete is then used between the columns. For most walls of this type, one or two rows of tiebacks are sufficient. For some of the larger slides, up to six rows of tiebacks have been used. Other types of walls can also be used for slide mitigation and function in a similar way to a shear key and buttress, but have the advantage of greater material strength and smaller size.

Construct Buttress and Shear Key (Increase Resisting Forces)

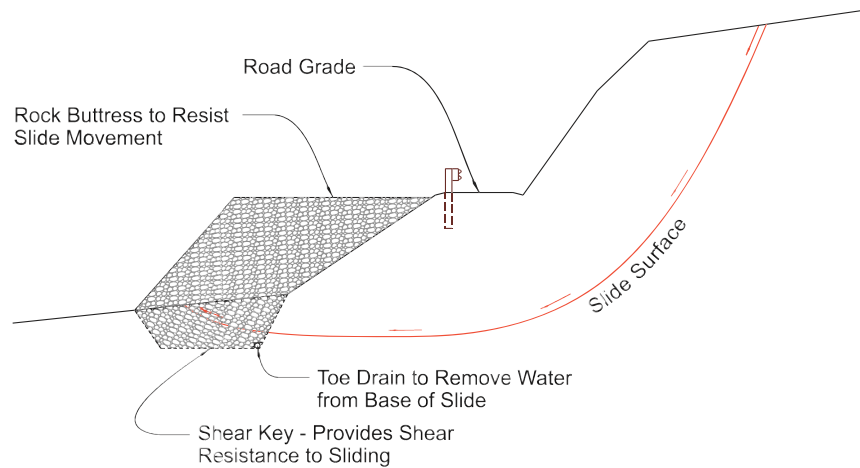

Figure B16: Constructing a shear key and buttress is one of the most common methods for stabilizing larger landslides due to the generally high resisting forces introduced, their ability to drain water, and their capacity to arrest slide movement. This is a more costly approach to slide mitigation, but it is one of the most effective. The shear key is simply a notch cut through the slide surface and into stronger, more resistant soil or even rock. This notch is fitted with a perforated pipe drain system and then backfilled with compacted stone embankment to form the "key" that provides shear resistance to sliding. The buttress constructed on top of the shear key provides strong material at the toe of the slide and additional mass to resist sliding; it also forces the key downward and increases its shear resistance. The dimensions of the shear key and buttress are dictated by the size of the landslide. In some cases, shear keys and buttresses are used independently, depending on need and site conditions. When buttresses are used without a shear key, they are known as counterbalances.

Unload Slide Mass (Reduce Driving Force)

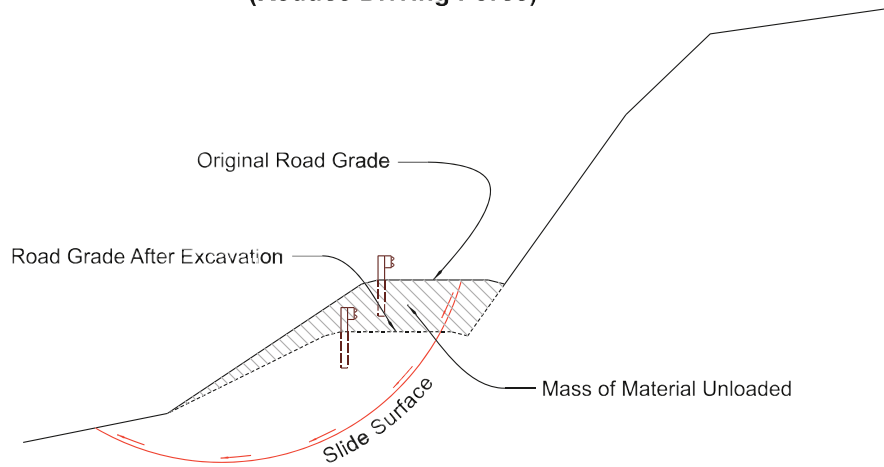

Figure B17: One of the simplest methods for stabilizing a landslide is to remove, or “unload,” as much of the mass of materials pushing down on it as possible. The more weight that can be removed from the top (head) of the slide, the more stable it becomes, and also the more resistant to seismic forces and effects. Slide unloading is used where the vertical alignment of the roadway can accommodate a lowered grade and in cases where the slide occurs above the road. This method is generally a low-cost approach to slide stabilization, and some further slide movement is expected after construction, although at a much lower rate and magnitude.

Flatten Slopes to More Stable Angles (Reduce Driving Force)

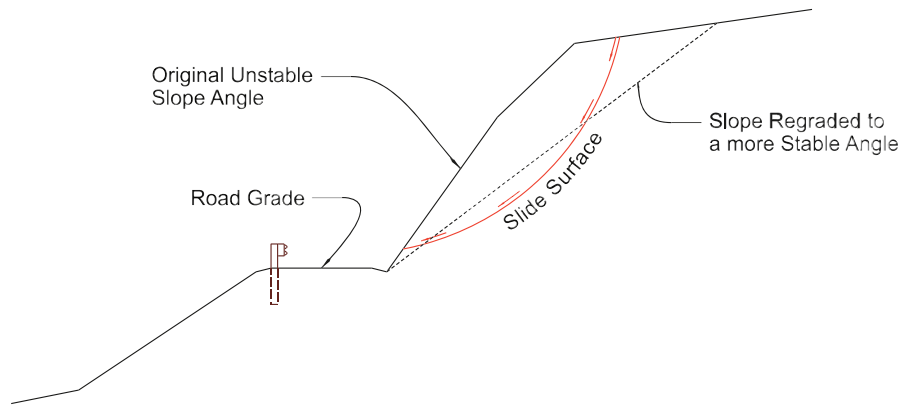
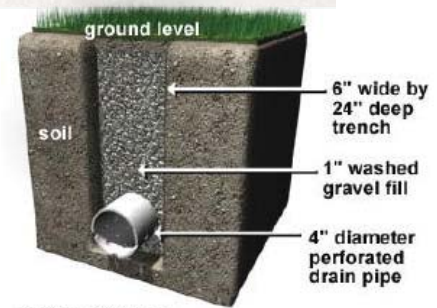
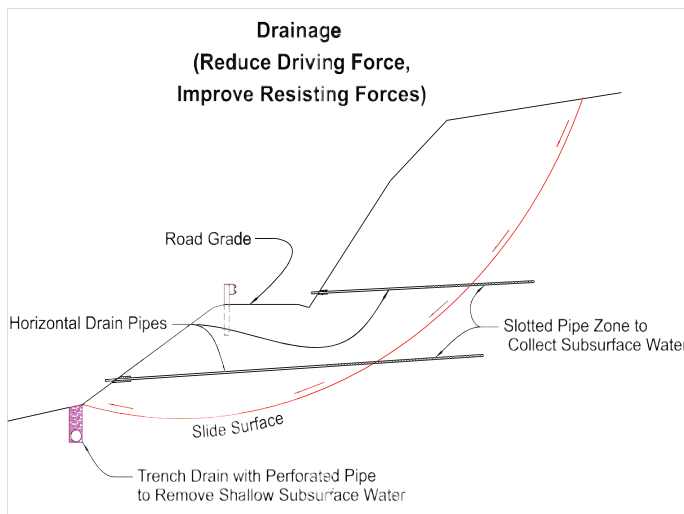

Figure B18: Steep slopes, coupled with weak materials and water, are one of the principle causes of landslides. Decreasing the angle of a cut slope is a common method used to decrease the driving forces acting on the slope or landslide. Not only can the head of a slide or unstable slope be unloaded, but a more stable geometry can be created by the flatter slope configuration. The angles at which cut slopes can be constructed are a function both of the material's strength and height and of any groundwater seepage in the slope. Rock slopes can be cut almost vertically, while weak clay materials must sometimes be cut as shallow as four feet horizontally for every one foot of height. Flatter slopes are more resistant to ground shaking in an earthquake, but are limited by the amount of adjacent property that must be acquired to construct them.



3D art by Marty Hovey



Figure B19: Drainage is one of the most cost-effective methods of landslide mitigation and usually forms some aspect of every landslide mitigation design. Water increases the weight of a slide mass while decreasing the shear resistance of soil and rock materials, so removing it greatly improves stability. One method is to construct trench drains, a feature commonly known as a French drain. Trench drains are used to intercept subsurface water and conduct it to nearby streams or storm drain systems. The drain can be dug as deep as an excavator can reach, sometimes up to 20 feet deep. Gravel backfill intercepts the groundwater and allows it to seep down to the perforated pipe. From there, it flows to the intended location away from the landslide. Horizontal drains are used to remove groundwater from deep within a slide mass. They are constructed by drilling holes horizontally into the slide and past the slide surface. Pipes with slotted sections to allow inflow are inserted into the drill holes and sealed at the surface with cement grout to prevent erosion at the pipe outlet. Horizontal drains are targeted at water-bearing zones identified by exploratory drilling during project design. A drainage-only approach to slide mitigation will not eliminate slide movement. It will, however, reduce the rate of movement of the largest landslides to manageable levels. Effective slide drainage also improves performance during a seismic event, as less water in the slide mass improves its reaction to strong ground shaking and reduces the effects of liquefaction.

Replace Embankment with Lightweight Materials (Reduce Driving Force)

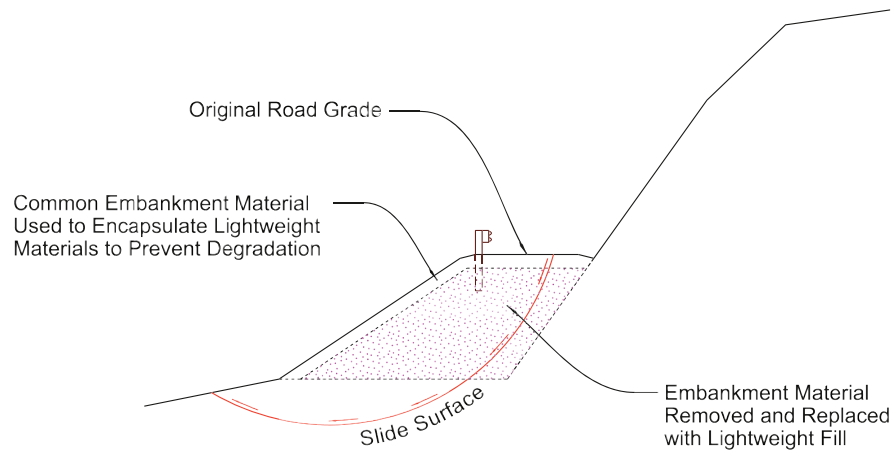

Figure B20: Lightweight fill is similar in principle to unloading: the mass of soil or rock driving the landslide is reduced by replacing it with a lightweight material such as wood chips. This method is used instead of unloading where the roadway cannot accommodate changes to the vertical alignment. The embankment is reconstructed from materials with a much lower unit weight to reduce the driving forces. Instead of having an embankment made of soil that ranges from about 95 lbs/ft³ to 115 lbs/ft³, one can be constructed from material that weighs 30 lbs/ft³ to 35 lbs/ft³—or about 1/3 the mass of the original embankment. An emerging technology that uses foam blocks to construct embankments is being considered. These materials weigh about 1 lb/ft³, which would almost negate the mass of an embankment over a landslide. In all cases, a thin layer of soil must be used to encapsulate the lightweight materials to prevent degradation that would result in excessive settlement below the road grade.

A STRATEGIC APPROACH TO IMPROVING RESILIENCE

As the previous section shows, much can be done to improve Oregon's transportation infrastructure so that it is better able to withstand a major earthquake and support both emergency response and long-term recovery. To make such improvements feasible and effective, however, a strategic approach is needed to prioritize mitigation efforts.

Proposed Lifeline Routes

In 2011, ODOT contracted with CH2M Hill to complete the Oregon Seismic Lifelines Identification Project. The Oregon Seismic Lifeline Routes (OSLR) study is designed to address Policy 1E, Lifeline Routes, of the 1999 Oregon Highway Plan, which states: "It is the policy of the State of Oregon to provide a secure lifeline network of streets, highways, and bridges to facilitate emergency services response and to support rapid economic recovery after a disaster." The report summarizes a newly developed study methodology to help prioritize system management measures at a corridor level. In addition to the facility and geophysical data addressed in earlier studies, this study added new considerations, including connections to population areas; locations of hospitals, fire stations, energy utilities, fuel storage facilities, and sites of other essential materials and services; and connections to other modes that will be important in a major emergency, such as airports, ports, and freight routes. In this way, the OSLR study looks at vulnerabilities, key connections, and roadway capacity to identify routes that need to be made more resilient to facilitate response after an event.

The design event for this study is a major Cascadia Subduction Zone earthquake with likely related events, including tsunamis, landslides, liquefaction of soils, and dam failures. The reason for focusing on this event is that it would have regional to multi-state impacts and would require a multi-state and federal response. Not only would it have significant impacts on the surface transportation system, requiring mobilization of many levels of emergency response, its effects would also be far-reaching. The result of the OSLR work, completed in April 2012, is a recommended, regional, corridor-level Oregon Seismic Lifeline System.

The study area is the geographic region of the state most susceptible to a seismic event and related impacts: generally, the populated areas along the Interstate 5 corridor and locations to the west of it. Although Klamath Falls is outside of the vulnerability area for a subduction zone earthquake, it is included in the study due to its proximity to active crustal faults. The area east of I-5 to U.S. 97 was also included in the study area, because access to the east side of I-5 is necessary to connect to emergency response services that will likely be staged at the Redmond Municipal Airport. In addition, the U.S. 97 corridor will be critical to support economic recovery.

Oregon Seismic Lifeline Routes (OSLR) Project Study Area

All Oregon state highways within the study area were considered. The process started with the selection of a subset of those highways that appeared to be good candidates for lifeline routes. The list of possible routes went through a triage process to increase the efficiency of the OSLR project and to decrease the effort

required to analyze the data along each route. State highways west of U.S. 97 were selected for inclusion in the evaluation because they had one or more of the following characteristics:

- Likely ability to promote safety and survival through connections to major population centers with survival resources.
- Currently used as a strategic freight and/or commerce route.
- Connection between seismically vulnerable areas and one or more of the following key destinations of statewide significance identified by ODOT Maintenance as critical for surface connection to interstate resources:
 - I-84 east of Biggs Junction
 - U.S. 20 east of Bend
 - The California border on I-5
 - The California border on U.S. 97
 - crossing of the Columbia River into southwestern Washington
 - A port on the Columbia or Willamette River
 - A port on the coast
 - Portland International Airport
 - Redmond Municipal Airport

State highways in western Oregon that were not selected are considered important to the overall transportation system and local emergency response and recovery. For the purposes of this study, however, they were not considered to be good candidates for identification as statewide lifeline routes, because they do not connect major population centers, do not connect to destinations of statewide significance, or, in downtown Portland, are not considered primary facilities.

Geographic Zones

Each highway in the study was divided into segments, which can be grouped into the following six geographic zones within the western half of the state:

- Coast (U.S. 101 and connections to U.S. 101 from the Willamette Valley)
- Portland Metro (highways within the Portland metro region)
- Valley (circulation between the Portland metro area and other major population centers in the Willamette Valley)
- South I-5 (the section of I-5 south of Eugene/Springfield)
- Cascades (highways crossing the Cascades mountain range)
- Central (the U.S. 97/U.S. 197 corridor from Washington to California)

GROUPS CONSULTED

Several stakeholder groups provided comments and input in the process used to develop these recommendations. A wide range of perspectives was sought, because the potential seismic problem affects many parts of the state's

infrastructure and economy. Stakeholders included the Oregon Seismic Safety Policy Advisory Commission and the Department of Oregon Geology and Mineral Resources. Local bridges are also at risk, and local agencies were presented with ODOT's initial findings during development of these recommendations. Representatives of other transportation modes were consulted during the development of the Resilient Oregon Plan, including the Oregon Ports Association, Department of Aviation, Rail Advisory Committee, and Oregon Freight Advisory Committee. Portland State University and Oregon State University provided some information included in the report.

To gather the perspectives of stakeholders, ODOT made presentations and held question-and-answer sessions at meetings of legislative committees, local emergency management committees, and local agency organizations.

Within ODOT, regional staff, in addition to the Bridge Section, Planning Section, and Office of Project Delivery, were key to the process. Agency employees throughout the state have hands-on knowledge of highway system operations and relationships with the local interests who depend on the bridges and highways containing unstable slopes and slide areas.

In addition to gathering information from people and groups, a Portland State University team used economic modeling to estimate the economic impacts of freight routes and proposed courses of action.

REFERENCES

Government of Japan, Ministry of Economy, Trade and Industry, National Policy Unit. (2012, March). Road to Recovery. Retrieved from: http://www.kantei.go.jp/foreign/policy/documents/2012/icsFiles/afieldfile/2012/03/07/road_to_recovery.pdf

Nako, A., Shike, C., Six, J., Johnson, B., Dusicka, P., & Selamawit, M. (2009, November). *Seismic Vulnerability of Oregon State Highway Bridges: Mitigation Strategies to Reduce Major Mobility Risks*. Salem, OR: Oregon Department of Transportation, Bridge Engineering Section.

ODOT Transportation Planning Analysis Unit. (2013, January). *Estimated Economic Impact Analysis Due to Failure of the Transportation Infrastructure in the Event of a 9.0 Cascadia Subduction Zone Earthquake*. Salem, OR: Author.

Oregon Department of Geology and Mineral Industries (DOGAMI). (2012, Winter) *Cascadia*. Portland, OR: Author.

The Pacific Northwest Seismic Network, USGS. (2008). Earthquake Hazards in Washington and Oregon: Three Source Zones. Retrieved from: [http://www.ess.washington.edu/SEIS/PNSN/\(last updated 8/28/2008\)](http://www.ess.washington.edu/SEIS/PNSN/(last%20updated%208/28/2008)).

Tobias, L. (2009, April 19). Big earthquake coming sooner than we thought, Oregon geologist says. The Oregonian. Retrieved from: http://oregonlive.com/news/index.ssf/2009/04/big_earthquake_coming_sooner_t.html

U.S. Geological Survey. (2012). Magnitude 9.0 Near the East Coast of Honshu, Japan, March 11: Earthquake Summary. Retrieved from: <http://earthquake.usgs.gov/earthquakes/eqinthenews/2011/usc0001xgp/#summary>

APPENDIX C

LIFELINE SELECTION SUMMARY REPORT

1.0 Introduction

1.1 Project Background

The Oregon Department of Transportation mission is “to provide a safe, efficient transportation system that supports economic opportunity and livable communities for Oregonians.” To fulfill that mission, the Oregon Transportation Commission makes decisions about how best to maintain transportation facilities for multiple purposes including public safety and resilience in the case of natural disasters. This study is the latest addition to ongoing efforts to maintain transportation system resilience, this time focused on earthquakes and associated hazards.

Specifically, the Oregon Seismic Lifeline Routes (OSLR) identification project has produced this study which includes recommendations for designation of a Seismic Lifelines System. The study was designed to address Policy 1E, Lifeline Routes, of the 1999 Oregon Highway Plan, which states: “It is the policy of the State of Oregon to provide a secure lifeline network of streets, highways, and bridges to facilitate emergency services response and to support rapid economic recovery after a disaster.” This project advances ODOT’s commitment to support a secure lifeline network by addressing system vulnerability issues within the right of way of existing highway facilities.

This report is not an emergency response plan. ODOT participates in emergency response planning statewide as a First Responder for Transportation and Public Works functions and has a formal Emergency Operations Plan, administered in the Maintenance Division, which includes agreements with other emergency service providers statewide. This current effort is to develop **a strategy for the state highway system to support emergency response and recovery efforts by providing the best connecting infrastructure practicable** between service providers, incident areas and essential supply lines to allow emergency service providers to do their jobs with minimum disruption. It is also intended to support community and regional economic recovery after a disaster event.

The Oregon Highway Plan Lifeline Routes policy also states that “ODOT’s investment strategy should recognize the critical role that some highway facilities, particularly bridges, play in emergency response and evacuation.” ODOT Bridge section has taken the lead on identifying system vulnerabilities and connecting vulnerable bridges with available funding to increase system resiliency. This report summarizes a newly developed study method to help prioritize system management measures at a systems level. It includes data beyond the facility and geophysical data addressed in earlier studies and adds new considerations including population areas, locations of hospitals, fire stations, energy utilities, fuel storage facilities and other essential services, and connections to other modes that will be important in a major emergency such as airports, ports and freight routes. In this way, the study looks at vulnerabilities, key connections, and road capacity to identify routes that need to be made more resilient to facilitate response and recovery after a disaster.

While the OHP policy identifies earthquakes, flooding, landslides, wild fires, and other natural and man-made disasters as the types of events that ODOT plans will address, the “design event” for this study is a major Cascadia Subduction Zone (CSZ) earthquake with likely related events including tsunamis, landslides, liquefaction of soils and dam failures. **The reason for focusing on a Cascadia Subduction Zone event is that it would have regional to multi-state impacts and would require a multi-state and federal response.** A CSZ event would also have significant impacts on the surface transportation system, requiring mobilization of many levels of emergency response and having far-reaching economic impacts. The result of this work can be built upon over time to address issues not included here, including other natural hazards and interoperability with local transportation networks.

1.2 Report Overview

This report provides a high-level overview of the project to identify Oregon Seismic Lifeline Routes, summarizing the processes conducted and conclusions reached. Many more details about the data and methodology used, as well as the specific results of the OSLR project, can be found in the *Seismic Lifelines Evaluation, Vulnerability Synthesis, and Identification report* (CH2M HILL, 2012).

The purpose of the OSLR project is to facilitate the implementation of Policy 1E, Lifeline Routes, in the *Oregon Transportation Plan*, which states, “It is the policy of the State of Oregon to provide a secure lifeline network of streets, highways, and bridges to facilitate emergency services response and to support rapid economic recovery after a disaster” (Oregon Department of Transportation [ODOT], 2006). The OSLR project helps to implement that policy by establishing the specific list of highways and bridges that comprise the seismic lifeline network. Further, it establishes a three-tiered system of seismic lifelines to help prioritize seismic retrofits on state-owned highways and bridges. The three tiers are described in some detail below. The OSLR project was conducted by the ODOT Transportation Development Division (TDD) from September 2011 through April 2012, in coordination and consultation with Bridge, Maintenance, Geotechnical, and other impacted divisions within the agency, as well as with other state agencies including the Oregon Department of Geological and Mineral Industries (DOGAMI) and the Public Utility Commission (PUC) through a Project Management Team (PMT) and Steering Committee (SC).

2.0 Process for Identifying Lifeline Routes

The study area was considered to be the geographic region of the State most susceptible to a seismic event and related impacts, that being, generally, the populated areas along the Interstate 5 corridor and locations west of I-5. The area east of Interstate 5 to US 97 was also included in the study area, because access to the east side of Interstate 5 was critical to key emergency response services and to widespread economic recovery. Figure C1 highlights the study area and the six geographic zones within the study area.

Within the study area, Oregon highways were considered. The process started with the selection of Oregon highways that were good candidates as lifeline routes for further evaluation, as identified by ODOT staff. This step was done to increase the efficiency of the OSLR project and to decrease the effort required to analyze the data along each route. State highways west of US 97 were selected for inclusion in the evaluation because they meet one or more of the following characteristics:

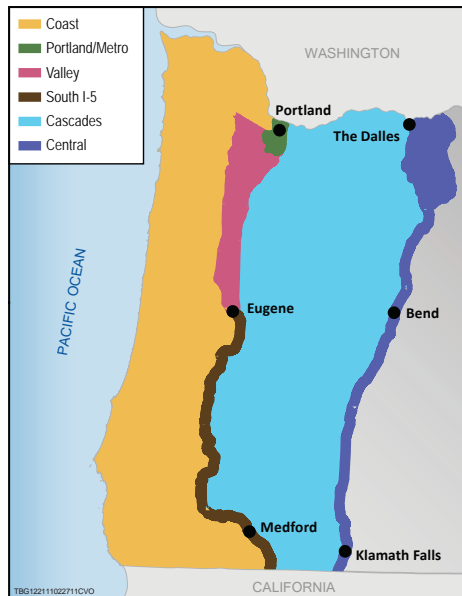

- Likely ability to promote safety and survival through connections to major population centers with survival resources
- Current use as a strategic freight and/or commerce route
- Connection to one or more of the following key destinations of statewide significance identified by ODOT Maintenance as critical for surface connection to interstate resources:
 - I-84 east of Biggs Junction
 - US 20 east of Bend
 - The California border on I-5
 - The California border on US 97
 - A crossing of the Columbia River into southwest Washington
 - A port on the Columbia or Willamette River
 - A port on the coast
 - Portland International Airport
 - Redmond Municipal Airport

Figure C1: Project Study Area and Geographic Zones

State highways in western Oregon that were not selected are considered important to the overall transportation system and local emergency response and recovery. However, for the purposes of this study, they were found not to be good candidates for identification as regional lifeline routes because they do not connect major population centers, or do not connect to destinations of statewide significance, or, in downtown Portland, are not considered primary facilities. Figures C2a-b depict the highways that were included in the evaluation.

Each highway in the study was divided into segments, which can be grouped geographically into the following six geographic zones (shown in Figure C1) within the western half of the state:

- Coast (US 101 and connections to US 101 from the Willamette Valley)
- Portland Metro (highways within the Portland metro region)
- Valley (circulation between the Portland metro area and other major population centers in the Willamette Valley)
- South I-5 (the section of I-5 south of Eugene/Springfield)
- Cascades (highways crossing the Cascades mountain range)
- Central (the US 97/US 197 corridor from Washington to California)

After selecting the highways for evaluation, an evaluation framework was established that includes goals, objectives, criteria, and parameters. **Goals** are the guiding principles for what the set of lifeline routes are meant to accomplish before, during, and after a seismic event. There are three main goals for Oregon seismic lifeline routes:

1. Support survivability immediately following the event
2. Provide transportation facilities critical to life support for an interim period following the event
3. Support statewide economic recovery

Evaluation Corridors

Page 1 of 2

Oregon Seismic Lifelines Identification Project

MAP FEATURES

- Urbanized area
 - Evaluation Corridors
 - Nodes
 - Insets
- (See Page 2 of 2)

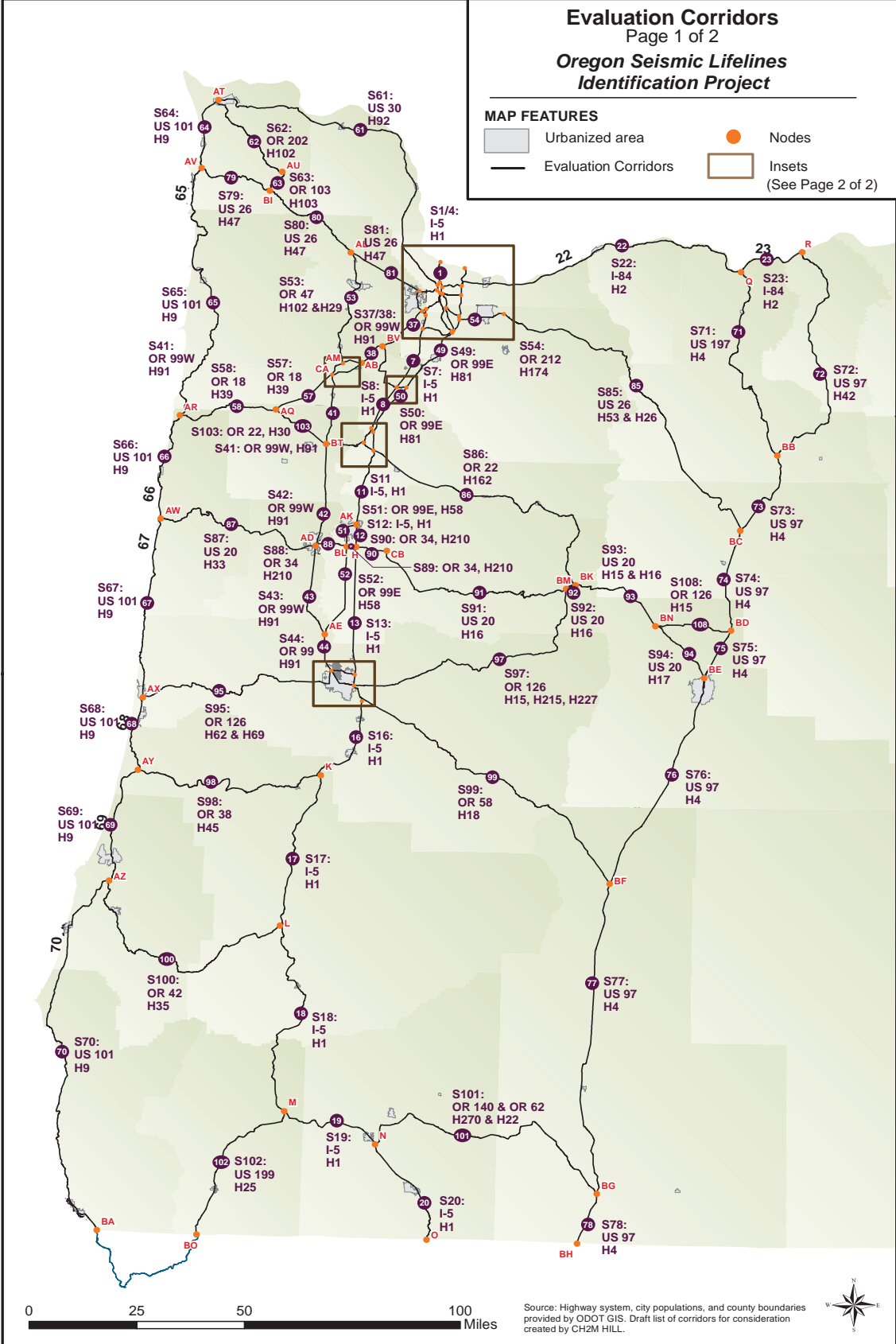
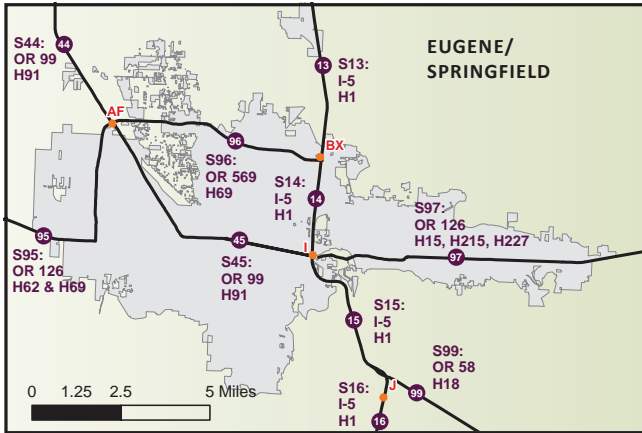

Figure C2a: Evaluation Corridors



Evaluation Corridors

Page 2 of 2

Oregon Seismic Lifelines Identification Project

MAP FEATURES

- Urbanized area
- Evaluation Corridors
- Nodes

Source: Highway system, city populations, and county boundaries provided by ODOT GIS. Draft list of corridors for consideration created by CH2M HILL.

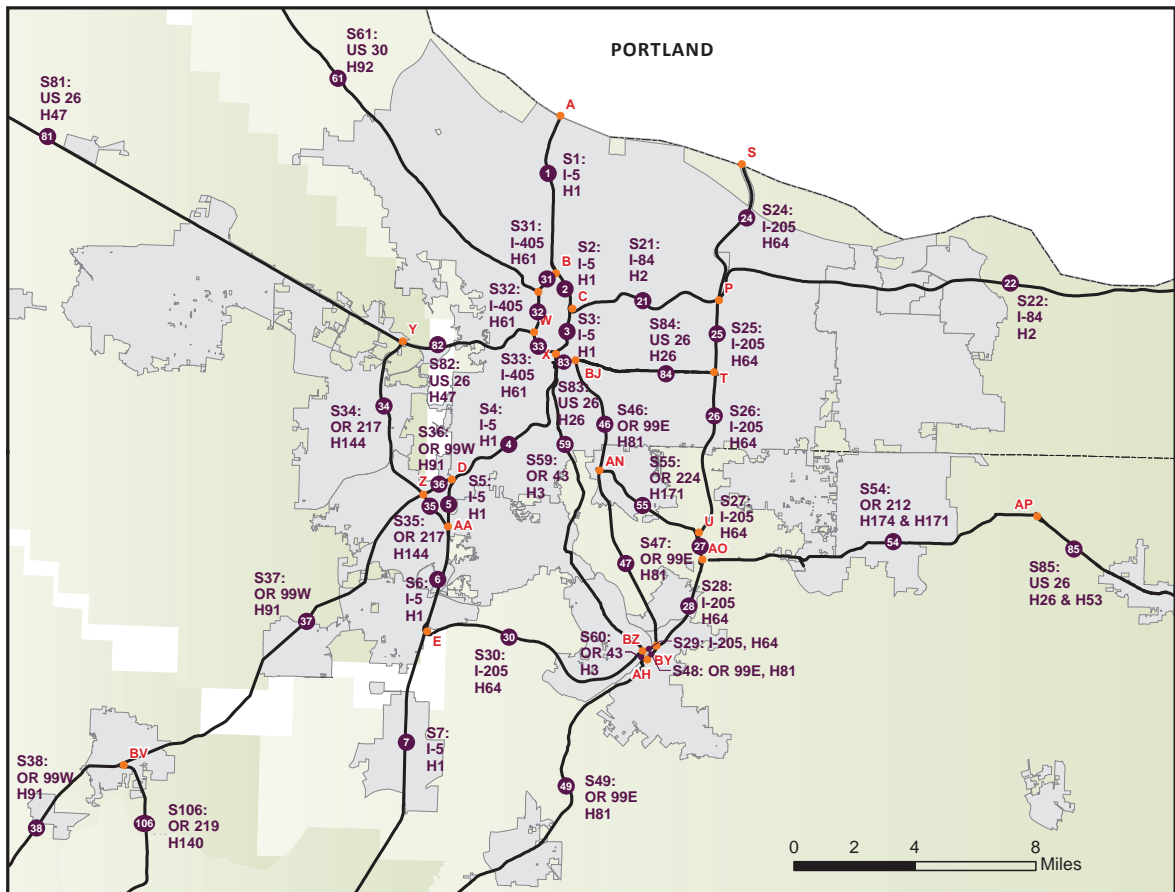
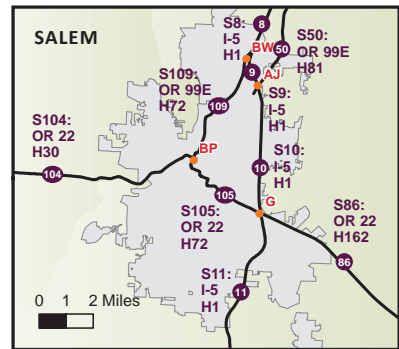
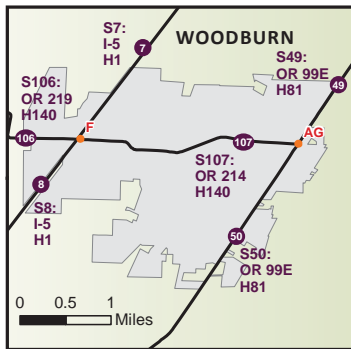
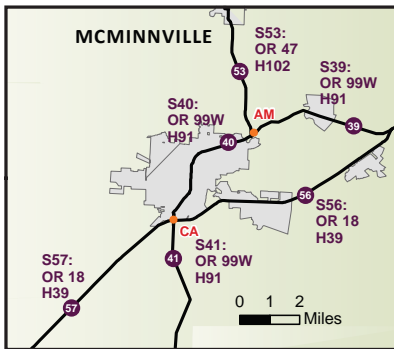

Figure C2b: Evaluation Corridors

These goals capture the need for seismic lifeline routes during three distinct time periods after a seismic event. Goal 1 refers to short term needs after an event, Goal 2 refers to mid-term needs after an event, and Goal 3 refers to long term needs after an event. **Objectives** are the specific actions that can be implemented to achieve each goal.

Goals	Objectives	Criteria
1. Support survivability immediately following the event (short term)	1A: Retain routes necessary to bring emergency responders to the emergency location	<ul style="list-style-type: none"> • Bridge seismic resilience • Roadway seismic resilience • Dam safety • Roadway width • Route provides critical non-redundant access to a major area • Access to fire stations • Access to hospitals • Access to ports and airports • Access to population centers • Access to ODOT maintenance facilities • Ability to control access during response and recovery
	1B: Retain routes necessary to (a) transport injured people from the damaged area to hospitals and other critical care facilities and (b) transport emergency response personnel (police, firefighters, and police), equipment, and materials to damaged areas	<ul style="list-style-type: none"> • Route provides critical non-redundant access to a major area • Bridge seismic resilience • Dam safety • Roadway seismic resilience • Access to hospitals • Access to emergency response staging areas
2. Provide transportation facilities critical to life support for an interim period following the event (<i>mid-term</i>)	2A: Retain the routes critical to bring life support resources (food, water, sanitation, communications, energy, and personnel) to the emergency location	<ul style="list-style-type: none"> • Access to ports and airports • Bridge seismic resilience after short term repair • Dam safety • Roadway seismic resilience • Access to critical utility components (such as fuel depots and critical communication facilities) • Access to ODOT maintenance facilities • Freight access
	2B: Retain regional routes to hospitals	<ul style="list-style-type: none"> • Access to hospitals
	2C: Retain evacuation routes out of the affected region	<ul style="list-style-type: none"> • Access to central Oregon • Access to ports and airports • Importance of route to freight movement

Each goal has two or three specific objectives. **Criteria** are categories of measurements for which data was available to support the evaluation of how well each segment can achieve the related objectives and goal. Table C1 lists the goals, objectives, and criteria within the evaluation framework.

Goals	Objectives	Criteria
3. Support statewide economic recovery (<i>long-term</i>)	3A: Retain designated critical freight corridors	<ul style="list-style-type: none"> • Freight access • Bridge seismic resilience after short-term repair • Roadway seismic resilience after short-term repair • Route provides critical non-redundant access to a major area • Access to ports and airports • Access to railroads
	3B: Support statewide mobility for connections outside of the affected region	<ul style="list-style-type: none"> • Access to central Oregon • Access to ports and airports • Freight access to railroads
	3C: Retain transportation facilities that allow travel between large metro areas	<ul style="list-style-type: none"> • Route provides critical non-redundant access to a major area • Connection to centers of commerce

Table C1: Evaluation Framework

Each segment was assigned a rating of high, moderate, or low with respect to its performance for each criterion. Once the results of the evaluation of each segment were established, weightings were assigned to each goal, objective, and criteria based on relative importance of the criteria and/or relative value of the available data, as assessed by the project teams. This allowed routes to be compared to each other in order to arrive at an overall rating. That rating was then used to help identify the most favorable seismic lifeline routes. These overall ratings, along with several other criteria discussed below, were then used to define the seismic lifelines as Tier 1, 2, and 3, as described in the next section.

3.0 Identification of Seismic Lifeline Routes

The results of the evaluation framework and a review of system connectivity and key geographical features were used to identify a three-tiered seismic lifeline system. The routes identified as Tier 1 are considered to be the most significant and necessary to ensure a functioning statewide transportation network. A functioning Tier 1 lifeline system provides traffic flow through the state and to each region. The characteristics of a sufficient Tier 1 system included:

- A contiguous network (all Tier 1 segments are connected to all other Tier 1 segments so that there are no isolated Tier 1 segments)

- Penetration of each geographic region of the study area with access to the most populous areas in those regions
- Access to the most critical facilities required for statewide response and recovery (facilities required for electrical generation and distribution, road building materials, communications, fuel delivery, etc)
- Access from the east to the most seismically vulnerable regions of the state
- Redundant crossings of the Willamette River in Portland (more than one crossing so that all traffic is not constrained to a single crossing)
- The Tier 1 system should be as small as possible to both meet the needs listed above and minimize the cost of retrofit and/or repair (provide the most important services for the least cost)

The Tier 2 lifeline routes provide additional connectivity and redundancy to the Tier 1 lifeline system. The Tier 2 system allows for direct access to more locations, increased traffic volume capacity, and alternate routes in high-population regions in the event of outages on the Tier 1 system.

The Tier 3 lifeline routes provide additional connectivity and redundancy to the lifeline systems provided by Tiers 1 and 2.

Together, the Tiers 1, 2, and 3 lifelines comprise the Oregon Seismic Lifeline System and are intended to accomplish the following:

- Include all of US 101 to provide access to all of the Oregon coast
- Include routes that have been identified as providing access to the most critical utilities
- Include all routes that have been identified as providing access to the nine State of Oregon emergency staging areas identified by the Oregon Office of Emergency Management.
- Include all routes that have been designated as strategic freight corridors or freight facilities

Figure C3 depicts Tier 1, 2, and 3 seismic lifeline routes. The sections that follow list the lifeline routes within each geographic zone.

In the discussion below, the roadways selected to serve as lifeline routes are referred to as corridors since it is not intended that the identified state highways be utilized as seismic lifeline routes to the exclusion of other alternatives in the same vicinity. Future seismic vulnerability evaluation and remediation prioritization efforts are likely to identify least cost alternatives for providing a seismically resilient route that include detours off of the identified roadway to bypass critical seismic vulnerabilities. Therefore the term “corridor” is used to denote that the identified highway, along with easily accessed adjacent roadways as necessary, are intended to serve as the seismic lifeline route.

PRELIMINARY Oregon Seismic Lifeline Route Designations

- Tier 1 Lifeline Route
- Tier 2 Lifeline Route
- Tier 3 Lifeline Route

- County boundaries
- Insets
- Interstate Route Marker
- U.S. Route Marker
- State Route Marker

Population
 Eugene More than 100,000
 Albany Between 2,501 and 100,000
 Tillamook Between 2,500 and 10,000
 Cities under 2,500 population not labeled.



Source: Highway system, urbanized area boundaries, and county boundaries provided by ODOT GIS. Lifeline route designations proposed by the Oregon Seismic Lifelines Identification Project. Map by CH2M HILL 2012.

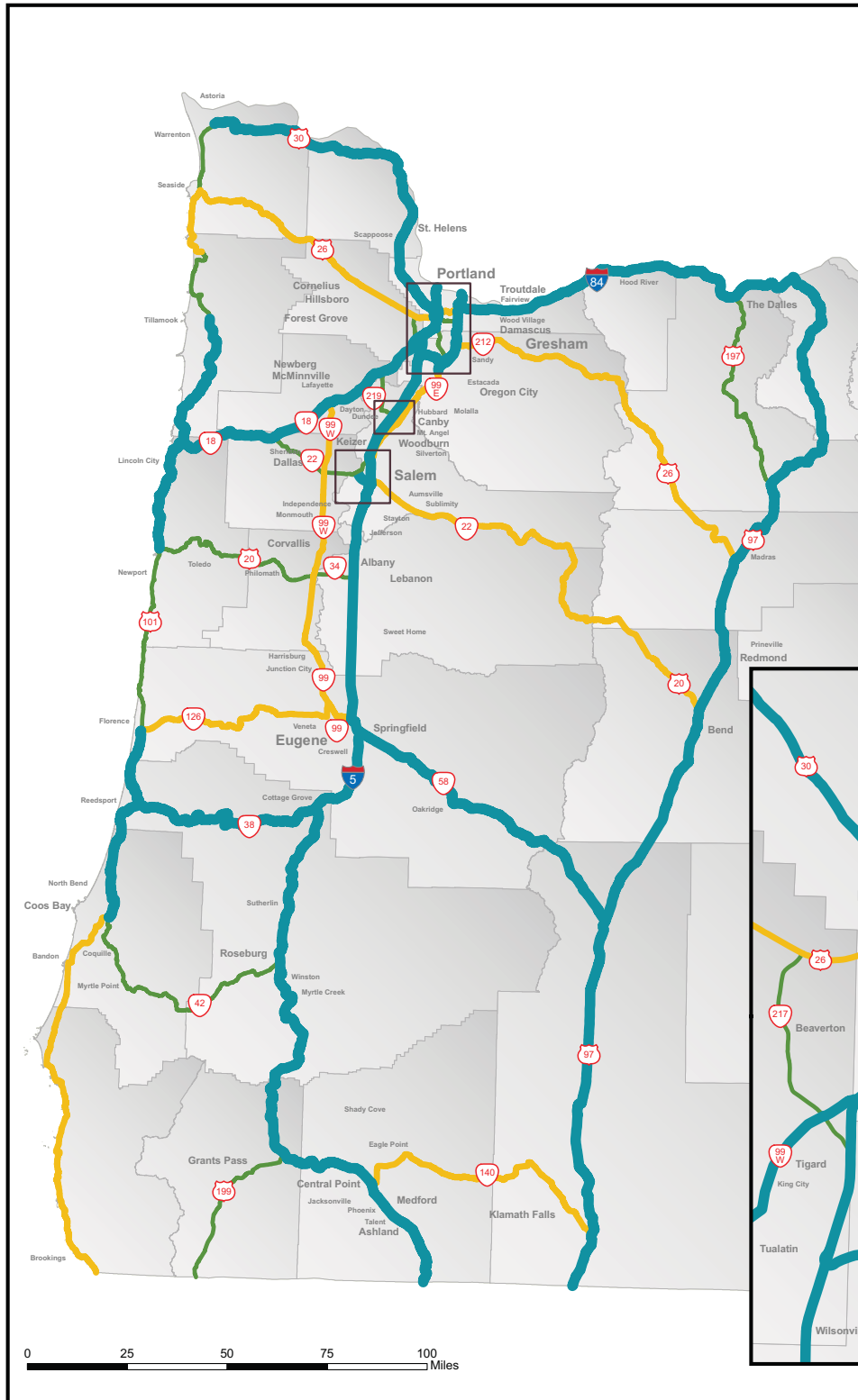

Figure C3: Lifeline Routes

3.1 Coast Geographic Zone

The Coast Geographic Zone is the most seismically vulnerable of all the geographic zones and the most difficult to access due to geographic constraints. While one could argue that the region's critical post earthquake needs should dictate that all routes be Tier 1, the reality is that the vulnerabilities in the Coast Geographic Zone are so extensive that the majority of the cost to make the entire lifeline system resilient would be incurred for repairs done within this region. Furthermore, because of the high vulnerability of the zone, it is paramount that emergency services and recovery resources are able to reach this zone from other zones. Consequently, the Consensus of the PMT and SC was that all needs are best served with a conservative Tier 1 backbone system, selected according to the criteria described in Section 3.0, above.

The Tier 1 system in the Coast Geographic Zone consists of three access corridors:

- OR 30 from Portland to Astoria
- OR 18 from the Valley to US 101 and north and south on US 101 from Tillamook to Newport
- OR 38 from I-5 to US 101 and north and south on US 101 from Florence to Coos Bay

The Tier 2 system in the Coast Geographic Zone consists of three access corridors:

- US 26 from OR-217 in Portland to US 101 and north and south on US 101 from Seaside to Nehalem
- OR 126 from the Valley to US 101 at Florence
- US 101 from Coos Bay to the California border

The Tier 3 system in the Coast Geographic Zone consists of the following corridors:

- US 101 from Astoria to Seaside
- US 101 from Nehalem to Tillamook
- OR 22 from its junction with OR 18 to the Valley
- OR 20 from Corvallis to Newport
- OR 42 from I-5 to US 101
- US 199 from I-5 to the California border

3.2 Portland Metro Geographic Zone

In addition to encompassing the largest population concentration in the state, the Portland Metro Geographic Zone contains facilities (such as transportation, communication, and fuel depots) that are critical to statewide earthquake response and recovery. For these reasons, it has a higher concentration of lifeline routes than the other geographic zones and redundant Tier 1 crossings of the Willamette River.

The Tier 1 system in the Portland Metro Geographic Zone consists of the following corridors:

- I-5, excluding the section between the northern and southern I-405 interchanges

- I-405
- I-205
- OR 99W from I-5 to OR 217

The Tier 2 system in the Portland Metro Geographic Zone consists of three access corridors:

- I-84
- I-5 between the northern and southern I-405 interchanges
- US 26 from OR 217 to I-405

The Tier 3 system in the Portland Metro Geographic Zone consists of the following corridors:

- OR 217
- US 26 from I-5 to I-205
- OR 43

3.3 Valley Geographic Zone

The Valley Geographic Zone generally consists of two or three North-South routes through the Willamette Valley and a variety of East-West connectors between those routes. It was desired to designate seismic lifeline routes that provide redundant North-South movement.

The Tier 1 system in the Valley Geographic Zone consists of the following corridors:

- I-5
- OR 99W from I-5 to OR 18 near Dayton
- OR 18 from OR 99W near Dayton to McMinnville
- OR 22 from I-5 to OR 99E in Salem

The Tier 2 system in the Valley Geographic Zone consists of the following corridors:

- US 26 from OR 47 to OR 217
- OR 99W from McMinnville to Junction City
- OR 99 from Junction City to I-5 in Eugene
- OR 99E from Oregon City to I-5 in Salem
- OR 214 in Woodburn from I-5 to OR 99E

The Tier 3 system in the Valley Geographic Zone consists of the following corridors:

- OR 219 from Newberg to Woodburn
- OR 99E in Salem from I-5 to OR 22
- OR 22 from OR 99W to Salem
- OR 34 from Corvallis to I-5

3.4 South I-5 Geographic Zone

The only roadway included in the evaluation in the South I-5 Geographic Zone is I-5 from Eugene to the California border. All of I-5 in this zone has been designated Tier 1 due to its importance in the region and the lack of alternate corridors.

3.5 Cascades Geographic Zone

The Cascades Geographic Zone consists of five crossings of the cascades from western to central Oregon. These routes connect the highly seismically impacted western portion of the state to the central portion of the state that is expected to have less impact from a Cascadia Subduction Zone event. In addition, the southernmost route can serve as a connection from Medford to the Klamath Falls area in the event of a seismic event in the Klamath Falls area.

The Tier 1 system in the Cascades Geographic Zone consists of two corridors:

- I-84
- OR 58

The Tier 2 system in the Cascades Geographic Zone consists of two corridors:

- OR 212 and US 26
- OR 22 from Salem to Santiam Junction and US 20 from Santiam Junction to Bend

There are no corridors designated as Tier 3 in the Cascades Geographic Zone.

3.6 Central Geographic Zone

The Tier 1 system in the Central Geographic Zone consists of the following corridors:

- I-84 from The Dalles to Biggs Junction
- US 97

There are no Tier 2 corridors in the Central Geographic Zone.

One Tier 3 corridor is in the Central Geographic Zone:

- US 197

4.0 Conclusion

This report provides ODOT with guidance about which roadways are most important for response and recovery following a major earthquake and which roadways are most easily prepared for, and repaired after, a major seismic event. Tier 1 lifeline routes are the most critical highways identified to provide statewide coverage; Tiers 2 and 3 lifeline routes would increase the usability of the system and add access to other areas. The next step in the process of planning for a seismic event is to prioritize mitigation and retrofit projects on these lifelines. Although this study has provided comparative results for seismic vulnerability on roadways, it does not provide sufficient detail to actually prioritize bridge and roadway seismic retrofits on a given highway. Additional engineering evaluations are needed to determine the needs for bridge and roadway seismic retrofit projects.

The information developed through this study will be used to update the Oregon Highway Plan, Lifelines Policy 1E by providing additional detail in the background section and by supporting revisions to policy actions that have been addressed by this and other activities since the policy was last amended. In addition, the Oregon Seismic Lifelines Map is expected to be adopted as part of the OHP.

5.0 References

CH2M HILL. 2012. Seismic Lifelines Evaluation, Vulnerability Synthesis, and Identification. May 15.

Oregon Department of Transportation. 2006. Oregon Transportation Plan.
<http://www.oregon.gov/ODOT/TD/TP/ortransplanupdate.shtml>. Accessed September 2011.

APPENDIX D

EXCERPT FROM 2009 SEISMIC VULNERABILITY STUDY

Development of ODOT Seismic Design Standards

Prior to 1958, seismic loading was typically not considered in the design of bridges. From 1958–1974 all bridges were designed for a seismic force equal to 2%–6% of structure weight (.02g-.06g). In 1971, the San Fernando earthquake marked a major turning point in the seismic design of bridges and began the development of a new set of design criteria for bridges in the US. In 1975 the American Association of State Highway and Transportation Officials (AASHTO) adopted Interim Specifications which were based largely on design criteria developed by the California Department of Transportation (Caltrans) in 1973. These code provisions were used by ODOT from 1975–1990. They resulted in an increased seismic design force equal to 8%-12% of structure weight and the introduction of ductile reinforcing details (Refer to Section 3 for further discussion regarding ductile reinforcement).

In 1989, the Loma Prieta earthquake in northern California prompted ODOT to take a very close look at the overall seismic hazard in Oregon and the affects of this hazard on bridge design. During this time, several earthquake hazard studies were taking place and various researchers and agencies were investigating and uncovering new evidence of an increased level of seismic hazard in Oregon. Field evidence was discovered indicating that large subduction zone earthquakes had occurred along the Oregon coast regularly in the past and active crustal faults were discovered in many other areas of the state that were not previously accounted for in the standard seismic hazard maps in use at that time. These newly discovered sources indicated a much higher level of seismic risk to ODOT bridges than previously accounted for in many parts of the state. At this time a seismic hazard study was also being conducted by Washington State University (WSU) for the Washington Department of Transportation (WSDOT), which resulted in an increase in seismic design ground motions for much of Washington State, above the values obtained from the AASHTO seismic design maps in use at that time. WSDOT adopted the results of this study for its use in seismic design. The area of this study extended into northern portions of Oregon, including Portland, and gave some insight into the potential increase in the seismic hazard in these areas.

In light of this new information, in 1990, ODOT decided to develop a statewide seismic design map of peak ground acceleration (PGA), based in part on the WSU report and also on recommendations from DOGAMI. This map was adopted for use in seismic design on an interim basis until a thorough study of the seismic hazard in Oregon could be completed. The PGA values on this interim map were significantly greater for much of the state than the values used before from the AASHTO hazard map, most notably in the Portland metropolitan area and along the southern Oregon coast. Also at this time (1990), a new AASHTO guide specification for the seismic design of bridges was adopted by ODOT for use with the new interim ground motion map.

In 1991, ODOT contracted with an earthquake engineering consultant firm (Geomatrix, Inc.) to conduct a seismic hazard analysis of Oregon and develop new seismic hazard design maps specifically for use in ODOT bridge design. The resulting report is an extensive study and compilation of all known active fault sources affecting Oregon and included the latest consensus on ground motion characteristics of the Cascadia Subduction Zone (CSZ). This report, titled “Seismic Design Mapping, State of Oregon,” is still considered to be one of the most important references documenting the seismic hazard in Oregon. The seismic hazard maps produced in this report for a 500-year return event were adopted by ODOT in 1995 and used for seismic design until 2004. In 2004, ODOT decided to adopt the 2002 USGS seismic hazard maps which are similar in level of hazard to the Geomatrix maps that were already in use. Also at this time, ODOT adopted a 1000-year return event for use in design (higher seismic design level) which was later adopted by AASHTO as the standard level of design hazard nationwide.

Another source of bridge damage resulting from earthquake ground shaking is liquefaction of the foundation soils. Liquefaction occurs when loose, saturated, sandy soils are subjected to ground shaking caused by earthquakes. This shaking creates excess porewater pressure in the soil and the soil loses most of its strength. Liquefied foundation soils can settle and also cause large horizontal ground displacements (lateral spread) which can produce very large loads on bridge foundations, to the point of causing bridge collapse.

Figure D1 is an example of bridge damage resulting from liquefaction of foundation soils. The effects of liquefaction on bridge performance was not accounted for in bridge design until about 1995 and mitigation of liquefaction damage potential was not included in routine bridge design until 2004. Therefore, bridges constructed before 1995 were not evaluated or designed for the effects of liquefaction or lateral spread. Bridges constructed between 1995 and about 2004 were evaluated for liquefaction potential, and if liquefaction was possible, these



Figure D1: Bridge pier damage resulting from liquefaction and lateral displacement of foundation soils (Yachiyo Bridge, 1964 Niigata, Japan)

effects were partially incorporated into bridge design. However, sites with the potential of lateral spreading were typically not mitigated.

Beginning in 2004, liquefaction leading to lateral spreading of embankments were all evaluated including the need for designing and constructing mitigation measures if necessary.

Year	AASHTO Design Code	Ground Motion Hazard
Prior 1958	Seismic loading typically not considered	N/A
1958-1974	Bridges designed for seismic force equal to 2%-6% of structure weight	N/A
1971	San Fernando, CA Earthquake	
1975-1990	Bridges designed for seismic force equal to 8%-12% of structure weight based on adopted AASHTO Interim Specs.	1975: Seismic Hazard Maps first appear in AASHTO; (Oregon in Zones 1 & 2)
1989	Loma Prieta, CA Earthquake	
1990	Adopt 1983 AASHTO Seismic Design Guide	Adopt 1990 interim ODOT Seismic Specifications Hazard Map
1995		Adopt 500-yr. Geomatrix design hazard maps (includes subduction zone event)
2004	Include liquefaction effects into routine design	Adopt 2002 USGS hazard maps; Adopted 1000-yr base design event

Table D1: A summary of the important events and changes made to the seismic design codes and ground motion hazard levels over time are presented.

Bridges located in the western portion of the state (west of the Cascade Range) or in the Klamath Falls area, constructed prior to 1975, are highly vulnerable with significant potential for damage and collapse. Bridges constructed between 1975 and 1995 in these areas are considered to have a moderate potential for damage or collapse. Bridges constructed after 1995 are much less vulnerable to damage or collapse since they were designed based on levels of ground shaking close to what is in use today and with much better design detailing. However, some of these bridges may still be vulnerable to significant damage or collapse if located in areas with liquefiable soils since liquefaction effects were not fully taken into account, or mitigated for, until about 2004. In 2004, ODOT adopted a higher level of design ground motion (1000-yr return event) for use in combination with the

no-collapse (life safety) criteria and also began designing and mitigating for the effects of liquefaction on bridge performance. Bridges designed since 2004 are based on ground motions, structural analysis, design detailing and liquefaction effects that are consistent with current design standards.

The potential for structural collapse of bridges constructed during specific time periods, when subjected to earthquake forces, is shown in the table below. The bridge collapse potential reflects the design codes that were in effect during each given time period.

Year Constructed	Structure Collapse Potential
Prior to 1975	Significant
1975-1994	Moderate
1995-2004	Low
2004-present	Very Low

Table D2: Structure collapse potential relative to year constructed

Current ODOT Seismic Design Philosophy

ODOT bridges are currently designed to at least meet the national bridge design standards established by AASHTO. This includes all standards related to seismic bridge design. Under these code requirements, bridges are primarily designed to meet a “life safety” performance standard, which means the bridge has a very low probability of collapse when subjected to earthquakes that are most likely to occur over the life of the structure.

The level of ground shaking used in the design is associated with earthquakes that on average could occur approximately every 1000 years. Even under the high level of shaking the bridge is designed for, it could likely suffer some amount of structural damage which would require repair. Like any natural event, an even larger earthquake could occur, resulting in larger movements than bridges are designed for. Bridge damage could be extensive enough to require complete replacement. This design philosophy is used because it would be too expensive to design bridges for the highest possible, but very rare, earthquakes.

ODOT seismic bridge design also includes a design check for a lower level earthquake event that occurs more frequently, on average approximately every 500 years. Under this lower level of shaking, the bridge is designed to withstand earthquake loads with minimal damage, such that the bridge can be opened to emergency traffic within 72 hours after an event. The inclusion of this additional lower level (“serviceability”) design is above the standard performance requirements prescribed by the AASHTO code.

Potential Damage And Failure Mechanisms

Ground shaking from earthquakes causes structures to also shake. For bridges, shaking occurs primarily in horizontal directions. This horizontal shaking and associated movement can cause damage to bridges.

A typical bridge is a combination of the following parts:

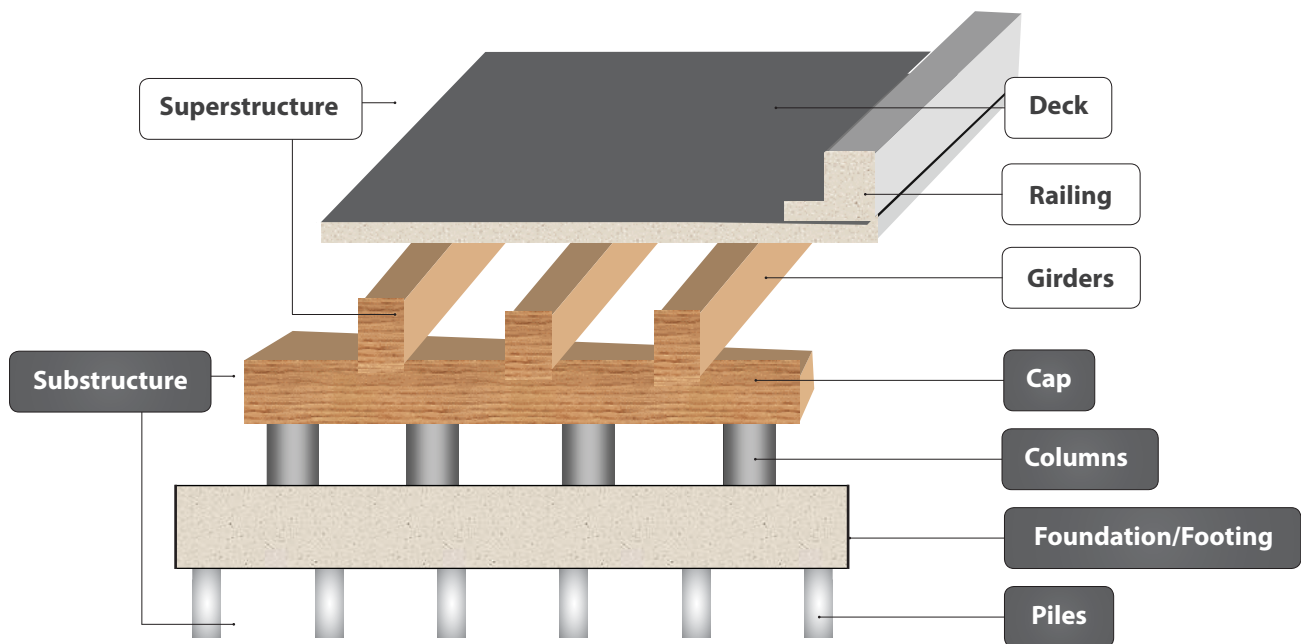

Figure D2: Typical Bridge Components

- **Deck:** The surface you drive on.
- **Railing:** Barrier at the edge of the deck.
- **Girders:** Members parallel to the roadway that support the deck.
- **Cap:** Members that support the girders.
- **Columns:** Vertical members that transfer loads from the cap to the foundation.
- **Foundation:** Members that transfer column loads into the ground. This generally includes a concrete footing that is either supported by the ground or supported by piling. Bridge ends (abutments) often do not have columns. For this case, the cap is connected directly to the footing and/or piling.
- **Piling:** Vertical members that transfer foundation (footing) loads into the ground. Piling normally extends down to a bedrock layer.

The deck, railing and girders together are called the "Superstructure." All other elements (cap, columns, footings and piling) together are called the

“Substructure.” The distinction between superstructure and substructure is important when considering potential damage from earthquakes and ways to retrofit a structure to avoid damage.

The horizontal movement from an earthquake typically does not do any damage to decks, railing or girders. These elements generally have robust connections between them which can easily accommodate horizontal earthquake forces. The connection between the superstructure and the substructure, however, is a major source of concern.

Bridge superstructure elements expand and contract (i.e., change length) with temperature changes as part of the normal bridge life. These movements are often accommodated by placing bearings underneath girders. These bearings provide a load transfer mechanism between the girders and cap. Bearings accommodate the large vertical loads (weight of the superstructure and vehicle loads) and transfer them from girders to cap, but also allow the small amount of horizontal movement that results from changes in temperature.

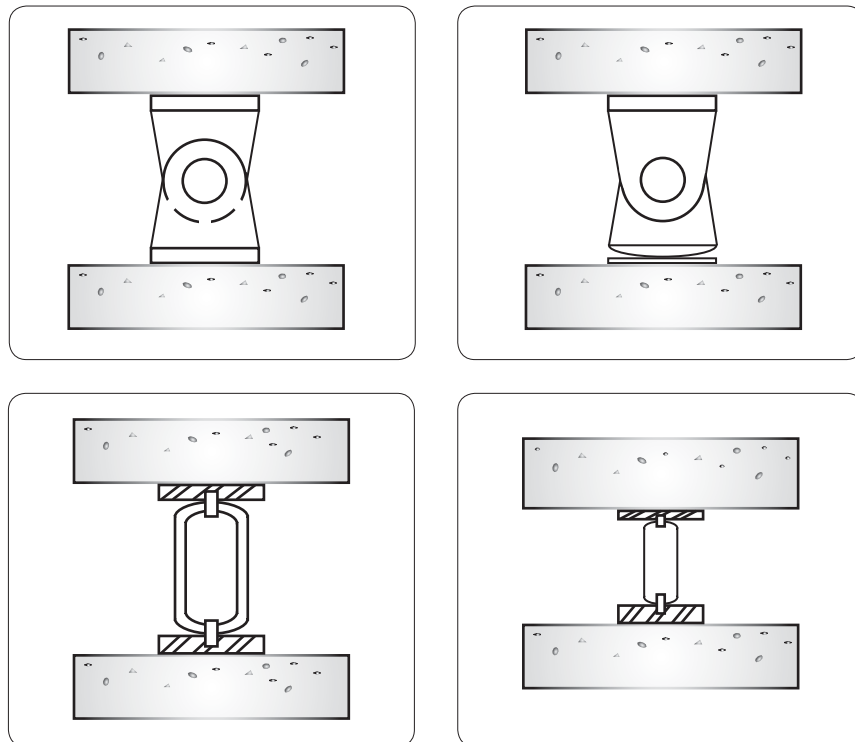

Figure D3: Rocker Bearings

Although bearings are very good at accommodating temperature movements, they are often poor at resisting horizontal earthquake loads. In some cases, support for a bearing may be compromised if an earthquake causes excessive horizontal movement of a girder. In extreme cases, bearings can topple.



Figure D4: Failed Rocker Bearings (Yamhill River Bridge)

Another approach to accommodating temperature movements is through use of in-span hinges. In-span hinges can also be poor at resisting horizontal earthquake loads. Use of in-span hinges is less common in modern bridges.

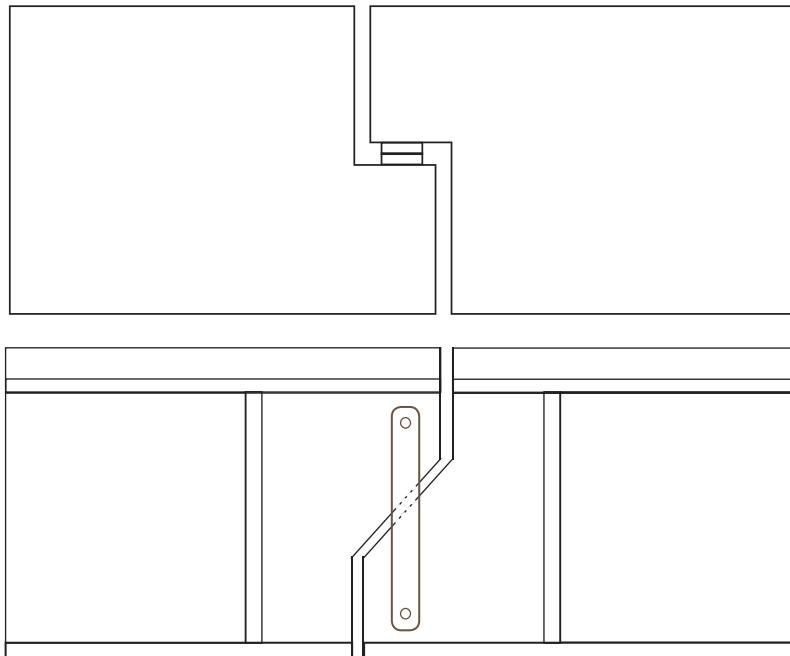

Figure D5: In-Span Hinges

Damage to bearings or hinges can be catastrophic. The result can range from an impassable gap or bump in the roadway (vertical displacement of adjacent deck segments) to complete collapse of a span.

Strengthening bridges to prevent damage is called “retrofitting.” Retrofitting bridges against bearing and hinge failures can involve any of the following:

- Replace unstable bearings with stable bearings.
- Provide additional seat width.
- Limit movement of girders parallel to roadway using restrainers.
- Limit movement of girders perpendicular to roadway using shear lugs.

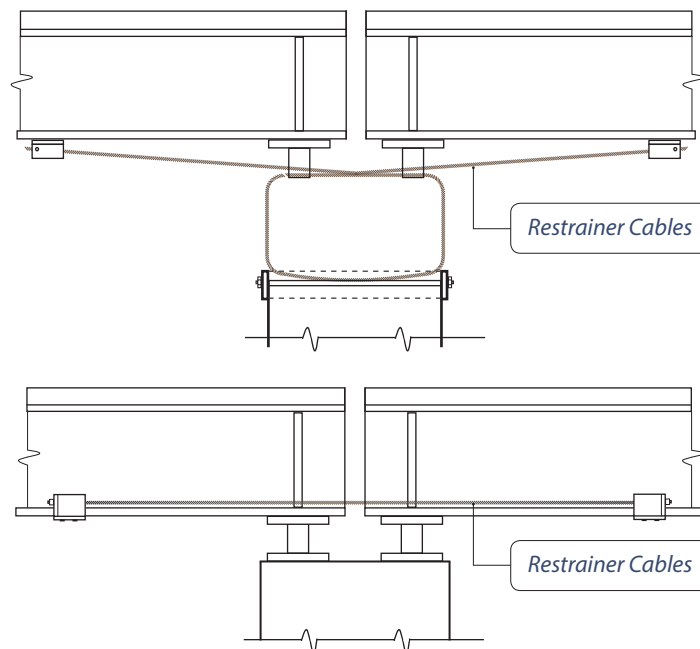

Figure D6: Restrainer at Pier

The cost of performing earthquake retrofit can be significant. The ODOT Bridge Program is funded at a level to maintain freight mobility and preserve major, high cost existing bridges, but not to retrofit existing bridges that are inadequate for seismic loading. Because of this, ODOT can only perform very limited earthquake retrofitting and must approach it in two stages. Phase I retrofitting includes only the items listed above. The essential goal of Phase I retrofitting is “life safety.” This is accomplished with retrofit details designed to prevent the superstructure from separating from the substructure and thereby preventing collapse of a span. This type of retrofit has proven to be highly effective for moderate earthquakes. However, since substructure deficiencies are not addressed, bridge collapse in a large earthquake is possible.

Phase II retrofitting includes strengthening the substructure elements. This includes caps, columns, footings and piling. The primary goal of Phase II retrofitting is also “life safety.” Since Phase II retrofitting involves strengthening substructure elements, the result is a final structure that can provide “life safety” for the maximum anticipated earthquake. The cost of Phase II work is typically three times that of Phase I. To date, ODOT has performed very limited Phase II retrofit work.

Caltrans also used a similar phased approach for earthquake retrofitting. Based on California’s experience and limited funding in the Bridge Program, ODOT has chosen to perform Phase I retrofitting only when other rehabilitation is needed on a specific bridge. Our current approach provides a moderate level of protection for isolated retrofitted bridges at a cost that is consistent with the current Bridge Program funding level. Since complete retrofit carries a much higher cost, this type of phased approach maximizes the benefit gained from each retrofit dollar spent.

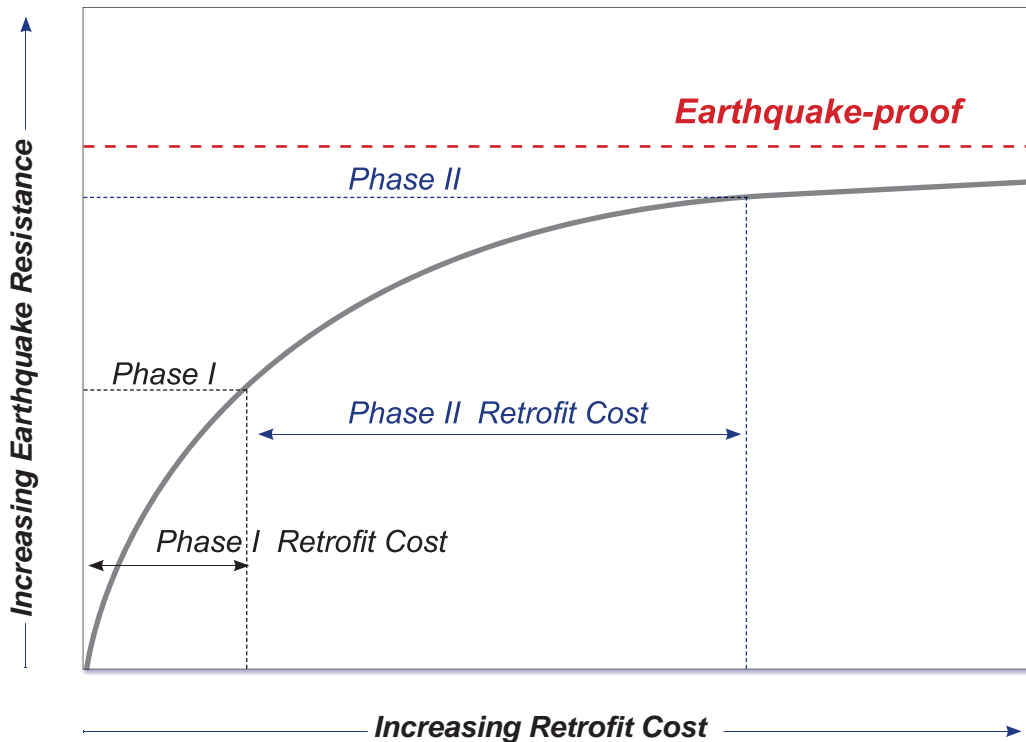

Figure D7: Cost-to-Benefit Comparison for Seismic Retrofit

Horizontal movement from earthquakes can damage columns, footings and piling of older bridges that do not have adequate seismic details. Column damage of older bridges as shown in Figure D8 below can be minimized by using “ductile” details. Ductile details allow a column to sway back and forth several times without significant damage. Ductile detailing involves ensuring vertical column bars have adequate containment or lateral support. With adequate lateral support, columns can bend without breaking. This design concept has been implemented on all ODOT bridges designed within the last 25 years.

Modern bridges are designed using tighter spacing for lateral reinforcing steel. This tighter spacing provides the necessary lateral support to ensure ductile performance. Earthquake retrofit for older columns would involve wrapping a column with steel or composite fabric to increase the lateral support.

Because older bridges were designed for much lower earthquake forces, their foundations generally lack capacity to resist the expected horizontal loads. Retrofit of older foundations usually requires increasing the size of footings. Where foundations are supported by piling, more piles must be placed. Because there is often limited room to work under existing bridges, foundation retrofit is both difficult and very costly.

The design philosophy for earthquake retrofit is similar to that of a new bridge. Where reasonable, retrofits are designed such that the bridge will be serviceable for a moderate earthquake and provide collapse prevention (life safety) in a large earthquake. However, it is not always possible to retrofit a bridge to the desired level without complete replacement. Even under the best circumstances, a new bridge designed and built according to today's standards would perform better than a retrofitted bridge.

The following sketch illustrates the various substructure retrofit concepts.

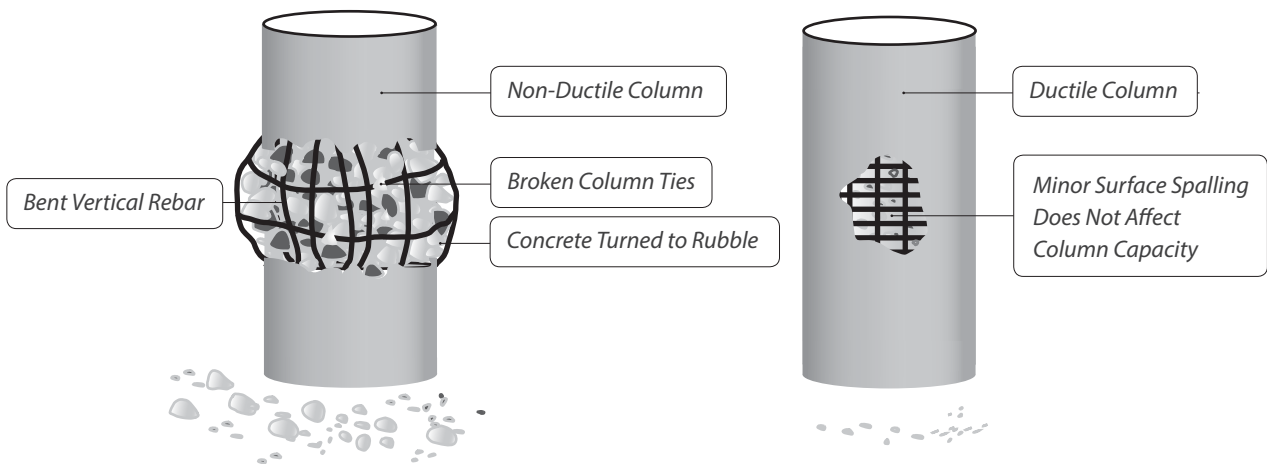

Figure D8: Concrete Column Detailing

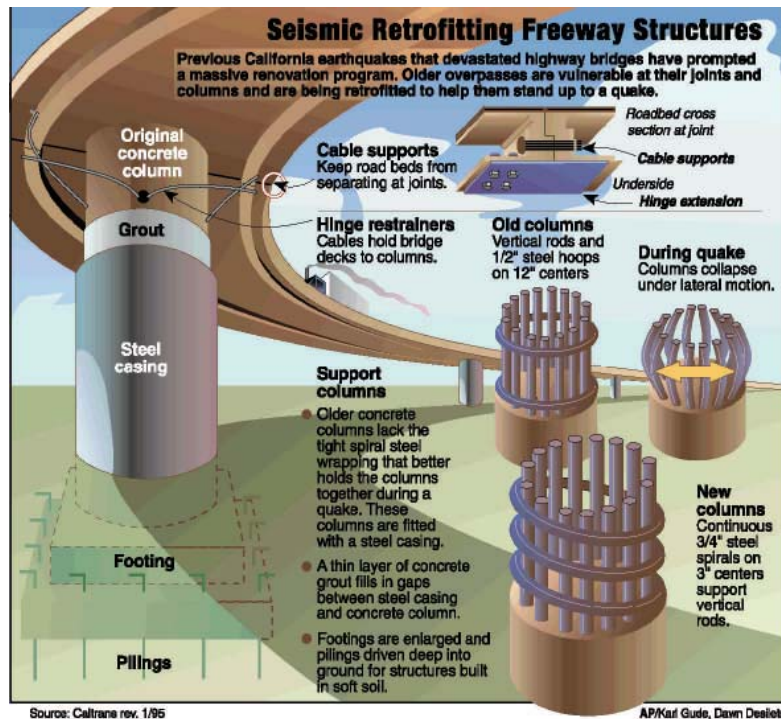

Figure D9 : Seismic Retrofit Concepts

The concepts shown above are based on traditional Phase I and Phase II retrofitting concepts. "Base isolation" is another concept that can be considered in some unique circumstances. Base isolation involves placing ductile elements between the superstructure and substructure. This usually involves replacing existing bearings between the girders and caps with special base isolation bearings. This type of bearing allows some horizontal movements, but limits the amount of earthquake shaking that can be transmitted from the substructure to the superstructure. In this way, base isolation bearings "isolate" the superstructure from the earthquake to a certain extent. In the end, the earthquake forces that must be resisted by the substructure can be dramatically reduced. In some cases, it can eliminate the need for a Phase II retrofit. Base isolation generally costs more than a normal Phase I retrofit, but is substantially less than Phase II retrofit. This concept is not effective or practical on all structures, but is considered where it is practical. The main span of the I-5 Marquam Bridge in Portland and the west approach spans for the I-205 Abernethy Bridge in West Linn are examples where base isolation was used. In both cases, base isolation did not eliminate the need for a future Phase II retrofit, but provided improved earthquake protection over a Phase I retrofit.

APPENDIX E

LEARNING AND INNOVATION THROUGH RESEARCH

The following are research efforts conducted to support the seismic vulnerability assessments and mitigation plan development that led to the Seismic Options Report. Detailed reports of these research projects are or will be available at the ODOT Research webpage: http://www.oregon.gov/ODOT/TD/TP_RES/ResearchReports.shtml

- Bridge Seismic Retrofit Measures Considering Subduction Zone Earthquakes, PSU, underway
- Prioritization for Seismic Retrofit with Statewide Transportation Assessment, PSU, underway
- Development of a Guideline for Estimating Tsunami Forces on Bridge Superstructures, OSU, October 2011
- Seismic Vulnerability of Oregon State Highway Bridges: Mitigation Strategies to Reduce Major Mobility Risks, ODOT Bridge Section and PSU, November 2009
- Refinement and Further Development of the REDARS Bridge Seismic Simulation Program, PSU 2008
- Bridge Seismic Retrofit Priorities using the Simulation Program REDARS, PSU 2006
- Tsunami Design Criteria for Coastal Infrastructure: A Case Study for Spencer Creek Bridge, Oregon, OSU, November 2006
- Assessment and Mitigation of Liquefaction Hazards to Bridge Approach Embankments in Oregon, OSU, November 2002

APPENDIX F

ODOT SEISMIC RETROFIT DESIGN PHILOSOPHY

ODOT bridges are designed to meet national bridge design standards established by AASHTO. This includes all standards related to seismic bridge design. However, the understanding of how seismic events affect bridges has changed dramatically with time. Because of this, older bridges were designed to less rigorous design standards. Now, many of them are known to be vulnerable to damage from a seismic event.

There are specific types of components that have been proven to be vulnerable in past earthquakes. When a bridge is strengthened (retrofitted) to increase the seismic resistance, it is usually these specific components or conditions which are evaluated. They include:

Bearings. Bearings are devices which allow vertical loads on a bridge girder to be transferred to the supporting system (substructure) while also allowing girders to change length as the air temperature changes. There are many types of bearings, but older bridges often used “rocker” type bearings, which can become unstable during an earthquake. Seismic retrofit requires investigation of bearings to determine whether they have the needed resistance under lateral earthquake loads. If they lack capacity, bearings can be replaced or strengthened, or alternate restraints can be added. The result of a bearing retrofit is to prevent a girder from becoming unseated from the bearing, thereby preventing collapse of a bridge span.

Hinges. Hinges are a gap in a bridge girder which allows girders to change length as the air temperature changes. Unlike bearings, hinges are within a span and not at a support. For older bridges, earthquake movements can potentially result in movements beyond the capacity of the hinge. Seismic retrofit of hinges involves installing restraints or keepers to prevent any movements beyond the hinge’s capacity. As with bearing retrofits, the result is to prevent collapse of a bridge span.

Columns and Piers. Columns and piers are vertical support elements that transmit girder forces to footing elements. Earthquake movements can cause these elements to bend. Critical bending is normally found where the column or pier connects to a footing. Well-detailed columns and piers can undergo significant bending without collapse. Older columns and piers require retrofit to correct any detailing deficiencies. Such a retrofit usually involves adding elements to confine the column or pier concrete, especially near the connection to the footing. This confinement prevents vertical bars in the column or pier from buckling under extreme bending and thereby prevents the primary type of failure.

Footings and Piles. Footings are elements which transmit column and pier loads to the supporting soil. Where soil support is weak, piles are used to transmit loads deeper into the soil where support is more secure. Older footings have steel reinforcement details, which have proved vulnerable in past earthquakes.

In addition, many older footings with piles simply lack adequate capacity to resist the anticipated earthquake loads. Measures for retrofitting footings normally involve adding an additional layer of concrete and reinforcing steel to the top of the footing. Retrofit of a footing with piles would include adding more piles around the perimeter and then enlarging the footing. Footing and pile retrofits are very costly. When seismic retrofitting requires footing enlargement and additional piles, the total cost of seismic retrofitting may exceed 50 percent of the replacement cost of the bridge.

Abutments. Abutments are the support elements at each end of a bridge. Abutments may contain footing and pile elements. Therefore, the vulnerabilities and retrofit techniques are often similar to footings and piles. Abutments must also support significant lateral loading during an earthquake. For this reason, abutments often require unique retrofit elements.

Single-Span Bridges. Single-span bridges have only one span and therefore do not have columns or piers. In general, single-span bridges perform better in earthquakes than multiple-span bridges. This is partially because they tend to be smaller.

Liquefaction. Liquefaction occurs when ground shaking causes the supporting soil to become “liquid” and lose some or all of its load carrying capacity. Sandy soils below the water table are most susceptible to liquefaction. Liquefaction becomes more likely as the magnitude and duration of an earthquake increases. Where liquefaction occurs, bridge damage and possible collapse increase substantially. Reliable mitigation methods are available for sites prone to liquefaction; however, these methods are quite expensive.

See Appendix D for an expanded discussion of ODOT seismic design history, potential failure mechanisms, and retrofit design methods.

APPENDIX G

SEISMIC PLUS ECONOMIC ANALYSIS: MAJOR EARTHQUAKE OCCURS¹

A major seismic event will significantly impact the Oregon economy immediately after and in the longer run. Results of this analysis indicate strengthening corridors before a major seismic event will enable the state to avoid a significant amount of economic loss. This analysis evaluated four alternative scenarios in order to gain a sense of the potential loss in production activity we could expect due to the damage to the transportation system after a major seismic event. Four scenarios representing seismic preparation and repair demonstrate the value added (impacts avoided) to the Oregon economy. Significant economic losses in production activity can be avoided by preparing for a major earthquake ahead of time. With no preparation ahead of time, Oregon could lose up to \$355 billion in gross state product in the 8 to 10 year period after the event. Proactive investment in bridge strengthening and landslide mitigation reduces this loss between 10% and 24% over the course of the eight years simulated for this analysis. Figure G1 presents the estimated cost of the preventive seismic work alongside the economic benefits, as measured by avoided loss of state production activity. This results in a benefit-cost ratio of 46 for the full seismic program.

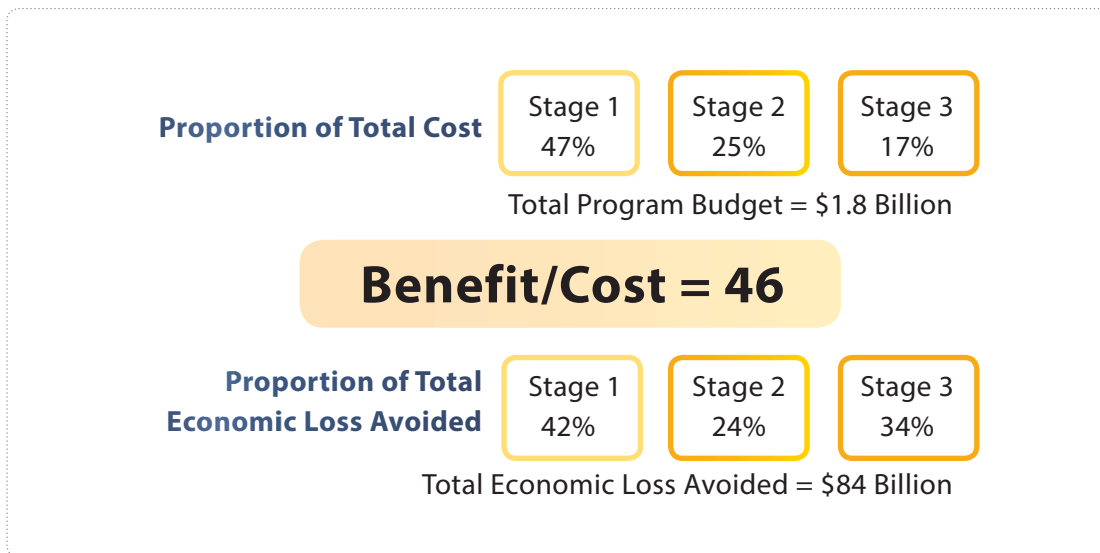

Figure G1: Estimated cost and benefit of preventive seismic work

¹Source: Memorandum from Becky Knudson, Senior Transportation Economist and Alex Bettinardi, P.E., Senior Integrated Analysis Engineer, ODOT Transportation Planning Analysis Unit

Real World Experience

Major events, such as a 9.0 Cascadia Subduction Zone earthquake, significantly impact an economy beyond short term emergency management issues. Several recent case studies from Japan, Turkey and New Zealand reveal a predictable pattern of economic disruption.² Generally speaking, the patterns are as follows:

- Very large proportion of small to medium sized firms fail the first few months after a major earthquake
- Firms attempt to adapt to post-event conditions to maintain business activity:
 - ◉ Maintain access to selling markets by choosing new routes and modes if necessary
 - ◉ Maintain access to production inputs by using firms able to provide what is needed, if local firms are unavailable, shift to next best supplier
 - ◉ Maintain access to workers
 - ◉ Relocate firm if access to necessary resources is constrained for a period long enough to threaten the firm's position in the competitive market
 - ◉ Once a firm relocates, there is little incentive to return to the previous location. Small and medium firms supporting production activity are likely to relocate near the new location area as well.

Every industry has a unique mix of production activity, logistical needs, and market presence driving business decisions. The long range impact of major damage to transportation infrastructure has the potential to significantly alter the industrial mix of an area. In turn, such changes will alter the characteristics of the economy, such as wages, population growth and land use.

Oregon Interpretation

Analysis conducted using the Statewide Integrated Model suggests the impacts of a major seismic event will result in significant reduction in production activity for the western region of the state. This study evaluated four scenarios representing multiple stages of strengthening corridors to withstand the impacts of a seismic event. The effects of a seismic event after a three stage pre-emptive program is implemented are compared to the effects of the event without seismic strengthening. The difference in the impact on production activity represented in the statewide model enabled the estimation of the avoided economic losses to Gross State Product (GSP).

Conducting seismic strengthening before the event occurs enables Oregon to avoid significant economic loss as measured by GSP alone. The losses avoided are larger than the cost of the repair programs, resulting in a good return on the investment.

² Small business failure/Port of Kobe losing demand permanently: <http://www.rms.com/publications/KobeRetro.pdf>; Loss of small businesses, skilled labor flight/firm loss in Turkey (under Economic and Business Losses section): <http://www2.ce.metu.edu.tr/~ce467/DOWNLOADS/erdik.pdf>; Association of Bay Area Governments on Turkey quake: <http://quake.abag.ca.gov/wp-content/documents/TurkeyFinal.pdf>; Tourism loss in Christchurch, area cordoned off from workers (50,000+ jobs relocated/lost): http://mceer.buffalo.edu/quakesummit2011/program/presentations/00-Thursday%20Plenary_d-Peek.pdf; Population flight in Christchurch:): http://mceer.buffalo.edu/quakesummit2011/program/presentations/00-Thursday%20Plenary_d-Peek.pdf

Particularly at risk of impacts to production is the Oregon manufacturing sector, because this industry is export-oriented and depends heavily on the transportation system to get goods to market and maintain access to the factors of production. Table G1 describes the manufacturing industry by firm size and employment. Given patterns observed in areas hit by major earthquakes in recent history, Oregon's manufacturing industry has the potential to lose a large proportion of firms and jobs in the first year, because small and medium firms are the most likely to fail shortly after a major event. This increases the likelihood of dependent firms relocating to areas unaffected by the earthquake. Repair and strengthening of the system before the seismic event will reduce the rate of firm failure, mitigating the economic impacts in the short and long run.

% of state	NAICS 31-33 Manufacturing	1 to 19 workers	20 to 249 workers	250+ workers	Total
5%	Establishments	4,062	1,108	98	5,268
	% of sector establishments	77%	21%	2%	100%
13%	Employment	21,086	70,561	76,604	168,251
	% of sector employment	13%	42%	46%	100%
	% of sector wages	6%	29%	65%	100%

Table G1: Manufacturing sector, first quarter 2011, statewide number of firms by size and employment (in thousands); source: Oregon Employment Department

It is important to note that the impacts reported in this analysis are likely to be lower than anticipated impacts occurring after a major earthquake. The dynamic relationship between the transportation system's support of everyday households and business activity, accommodating emergency services and rebuilding Oregon in the wake of such a devastating event are only partially accounted for in this analysis. Fully accounting for all the impacts to infrastructure and the interactions of the resulting failures requires much more detailed analysis, involvement from experts for other subject areas, and refined assumptions regarding the magnitude of the earthquake, system failures, repair and recovery, etc. This analysis only evaluates impacts and failures on the highway transportation infrastructure.

TECHNICAL ANALYSIS

The purpose of this analysis is to provide high level estimates of avoidable economic impacts caused by damage to the transportation system from a major seismic event (a 9.0 Cascadia Subduction Zone Earthquake, where the fault breaks along the entire subduction zone – a worst case earthquake scenario). Four alternative scenarios were used to evaluate the impacts of pre-emptive mitigation. This analysis was prepared for the ODOT Bridge Engineering Section, which is evaluating risks and identifying strategies to mitigate seismic vulnerabilities of the state highway system. The scenario approach was designed to provide a general

sense of the magnitude and direction of avoidable economic impacts to Oregon from damage occurring on the highway/street transportation system alone (non-transportation losses were not accounted for). This analysis focuses on the western portion of the state, defined as the area to the west of the Oregon Cascade Range.

Methodology

The analysis was conducted using the Oregon Statewide Integrated Model (SWIM). SWIM is a state-of-the-art model that integrates the Oregon economy, land use and transportation system into one dynamic interactive environment. This model design characterizes the synergies between these three major components of Oregon's economic activity.³

Only the roadway network was altered for the modeled scenarios. Corridors expected to experience damage from a major seismic event were represented as "failing." The points of failure were identified by the ODOT Bridge Engineering Section for high-use state-owned facilities. For lower use corridors and non-state owned facilities in the SWIM network, adjacent parallel routes within these corridors needed to be altered to maintain consistency in network coding. Therefore, the full network was reviewed and altered for consistency. Nearby facilities with similar proximity and characteristics of those identified to fail were represented to fail in the same manner.

Representing loss of commercial buildings or housing, damage to utilities, other damage or loss of life resulting from an earthquake was outside the scope and purposes of this analysis. This analysis was to determine the isolated impacts of the failure of the transportation system, not to create an estimate of the overall economic impact of a major seismic event. No changes were made to the regional forecast of economic activity by industry sector. The purpose of this analysis is to evaluate the effects of impacts to transportation on economic activity separately, apart from the other economic responses to a seismic event to the Oregon system. Because the interaction between land use, the economy and the transportation system is dynamic, the modeling results provide a good estimate of the magnitude and direction of the effects of the seismic reinforcement to Oregon's economy. Changes in spatial location of economic activity resulting in the transportation limitations were evaluated. The model acuity is very informative at a regional level. Regional aggregation of modeling results provides reliable indication of the relative economic impacts of preparing the transportation infrastructure for a seismic event.

Economic impacts were measured by evaluating the model output values for industry production activity, employment and population. The model outcomes do not represent the full economic impacts from seismic event, but this is appropriate given the intentional design of the scenarios to separate the impact of transportation system damage from the other effects, as well as identify the differences between the alternative levels of investment.

³ Further information on SWIM is available online: <http://www.oregon.gov/ODOT/TD/TP/pages/statewide.aspx>

Caveats

The results presented in this memo derive from hypothetical scenarios where only highways and adjacent local routes fail and all other infrastructure continues to operate as if no earthquake occurred. The analysis is designed to provide a general sense of high-level impacts avoided if proactive measures for the highway infrastructure were taken. Given that the analysis focused only on transportation infrastructure and did not account for loss of commercial buildings or housing, damage to utilities, other damage, or loss of life, these estimates are likely lower than what would actually occur when such a disruptive event occurs. A larger analysis effort is required to account for the impacts to people, infrastructure, and businesses that a 9.0 earthquake would cause. All consideration and use of the analysis results must reflect this context.

This analysis does not account for:

- loss of life and injuries
- loss of worker productivity as an input to industrial production
- savings from improved emergency service accessibility
- shifts of resources to provision of basic needs/services
- shifts of resources to re-construction from other industries
- loss in productivity due to lost capital, floor space, equipment, utilities and commodity flows
- damage to and failure of dams
- loss of electricity, water, telephone (cell and land lines), natural gas and fuel pipeline

It is important to note that true complete isolation is not represented in the model run, SWIM will not run if this were the case, in order to mimic conditions after a large event like this, damaged segments were assigned a new speed of 1 mph or a fixed travel time of up to a day to represent the difficulty of crossing the damaged segment. This is a reasonable simulation approach for aggregate analysis. Focused analysis would require specific locations be evaluated for likely solutions, such as floating bridges, ferries, and other countermeasures taken at each closure point, which is beyond the scope of this analysis.

A sophisticated tool such as SWIM is designed to simulate the interactive nature of the economy, population, households, industry location, freight movement, access to skilled workers, spatial relationships and the transportation system that connects them all together. To fully assess the economic impacts of an earthquake of this magnitude, the features bulleted above should be accounted for in the modeling specifications. The work completed for this analysis endeavors to isolate and estimate the avoidable economic impacts solely due to the loss or retention of sections of the highway system. While these scenarios are strictly hypothetical, they provide a broad sense of the benefit of investing in a seismic mitigation program and are appropriate for the question being addressed.

Description of Scenario Alternatives Evaluated

The Bridge Engineering Section provided a list of bridges and highway sections that “fail” after a major seismic event. For each scenario, a list of bridges repaired and opened was provided by the Bridge Section for five years after the seismic event. Repair schedules for lower functional class roads not identified by the Bridge Section were generated to be consistent with the state repair schedule. The model simulation includes eight years, beginning with the seismic event (year 0), five years of repair activity (years 1-5) and two years of continued economic activity (years 6-7) with a fully functioning highway system.⁴ All highway sections in the model were assumed to be open and operating as usual within five years. Thus, network characteristics modeled were the same for all scenarios for years 6 and 7.

Reference Scenario: This is the baseline comparison scenario with current highway conditions, no earthquake or major shocks to the transportation network, and economic growth consistent with current forecasts for the state for eight years.

Major Seismic Event: This scenario represents highway conditions after a 9.0 Subduction Zone earthquake occurs. This scenario serves as a hypothetical worst-case example representing the greatest level of highway damage. The scenario represents the list of state-owned bridges and sections of highway that “fail” and “repairs” them according to an estimated schedule provided by the Bridge Section.

In order to produce a modeled scenario with consistent post-earthquake routing, multiple lower functional class state highways and non-state-owned roads were coded to “fail.” Many of these bridges are off the state system, but included in the SWIM network. Thus, they were not specifically identified by the Bridge Section to fail. For example, OR 20 to the coast was identified to fail, but OR 34 was not (because it is a lower function road). In order to represent consistent effects from a major earthquake, OR 34 was coded to fail as well. All the lower functional class roads and off-system roads were coded to be rebuilt within 5 years to remain consistent with the state facility assumptions.

The sections of highways affected by failures are illustrated in Figure G2. The roadway network is color-coded to illustrate when corridors would be repaired and returned to pre-earthquake conditions. The time of completion ranges from 1 to 5 years. Figure G3 provides further illustration of the duration of area isolation due to damaged roads and bridges. Areas coded with the lightest color regain access to the highway system within one year, where the darkest red areas remain isolated for the full five year repair period. Isolation and damage due to loss of power, water, building collapses, fire and other causes are not included in Figure G3 or this analysis. Isolation means severely limited (day(s) of travel) access to markets for the local economy, causing delay in economic recovery.

⁴ The original intent was to run eleven years in order to evaluate a five-year period post repairs. In order to meet the analysis schedule, the simulation period was reduced to eight years. The objective of determining at which point the economy would recover to normal levels was not met given the shorter simulation period, but no other findings are affected by the shorter simulation period.

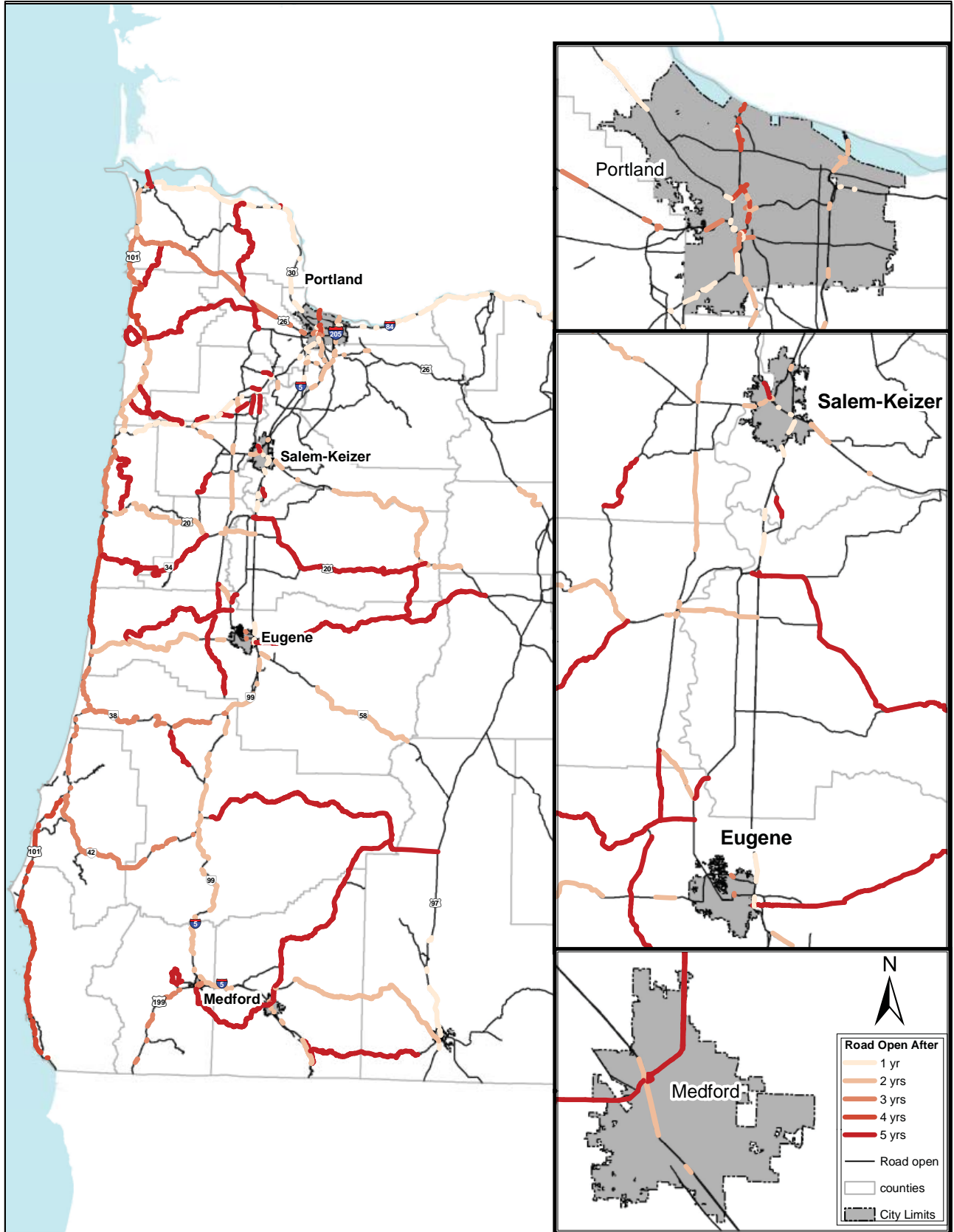

Figure G2: Failures and repair schedule: Major seismic event

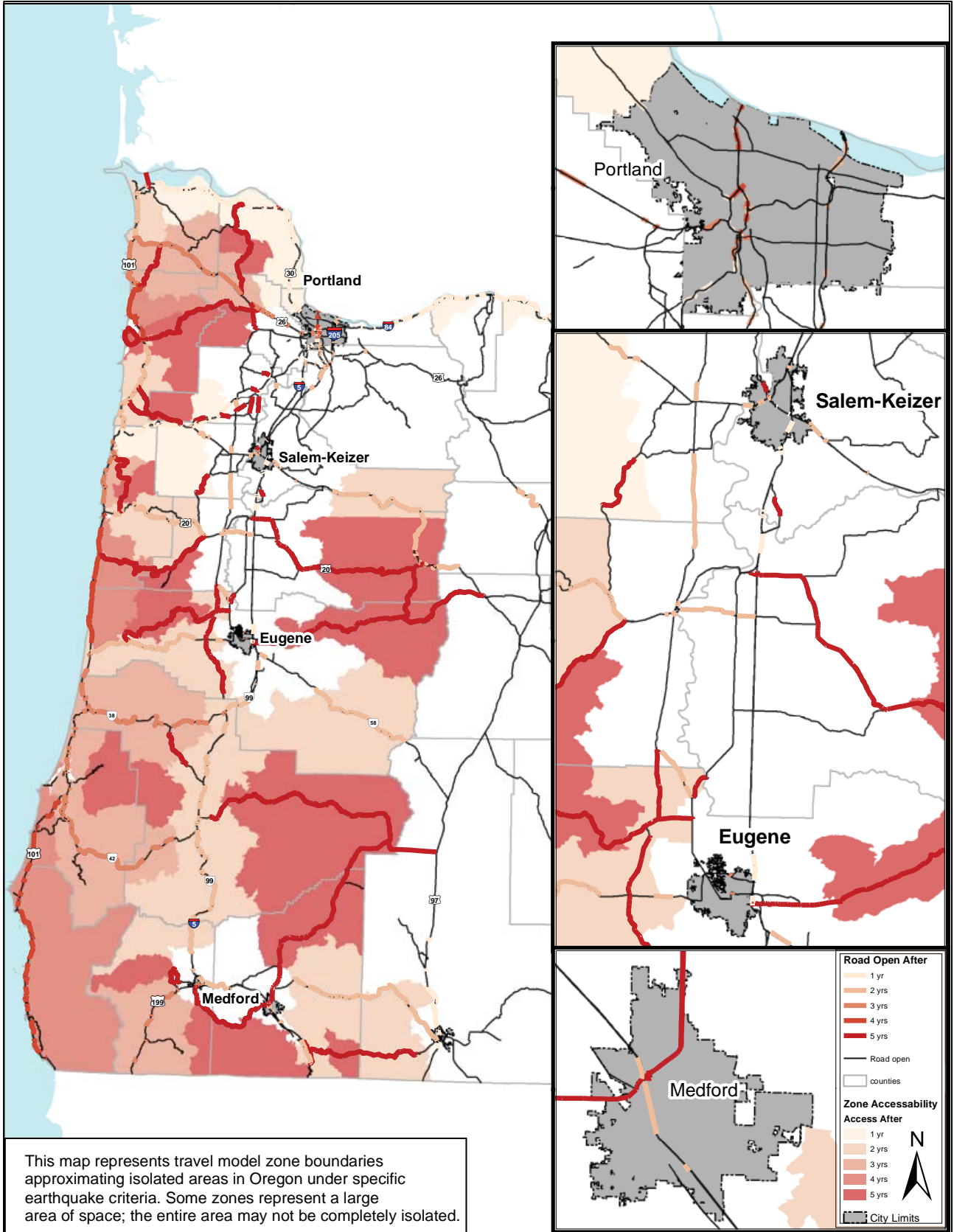

Figure G3: Isolated zones and repair phasing: Major seismic event scenarios

A seismic retrofitting, rockfall and landslide stabilization program budget was provided for three separate stages. Scenarios were designed to capture the effects of the individual stages in order to gain a sense of the economic benefits associated with each stage.

Stage 1: This scenario represents conditions after a 9.0 subduction zone earthquake, given the completion of seismic fortification for corridors identified in stage 1. Figure G4 illustrates the repair completion schedule and isolation timelines for this scenario. This scenario is represented in SWIM in the same manner as the Major Seismic Event scenario; the only difference is the presence of reinforced bridges and landslide/rockfall mitigation through a seismic improvement program. This program enables Oregon to avoid major earthquake damage to several key corridors, allowing faster and larger scale access to emergency services and supplies necessary to rebuild, as well as accelerated repair of damaged sections of the transportation system.

Stages 1 & 2 Scenario: This scenario represents investing at the Stage 1 level and adding Stage 2 improvements, as illustrated in Figure G5. This figure also reports the level of isolation by geographical location associated with this level of investment.

Full Seismic Program (Stages 1, 2, & 3): This scenario is the level of investment for all three stages of the program, as illustrated in Figure G6. This figure also reports the level of isolation by geographical location associated with the full seismic program.

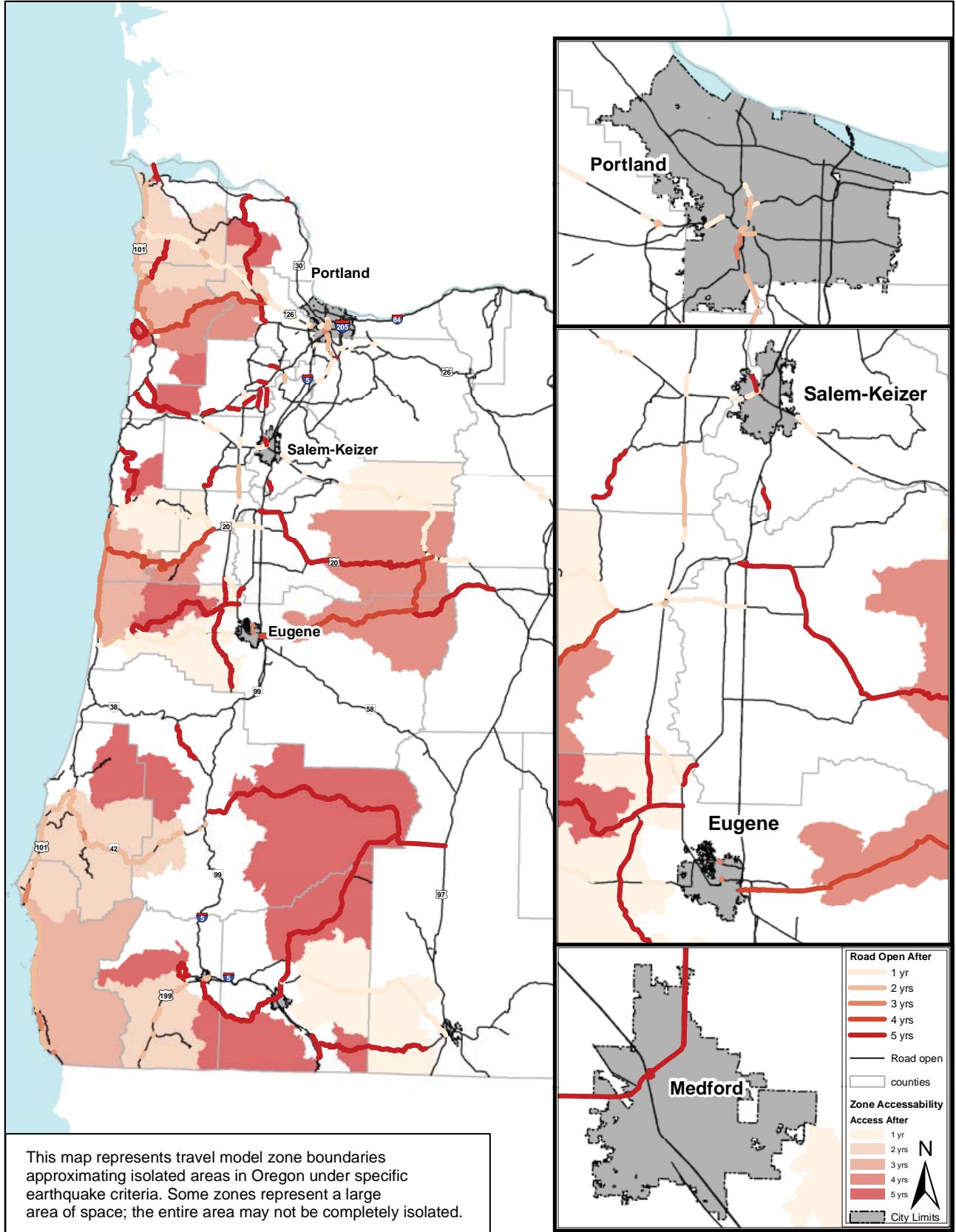

Figure G4: Isolated zones and repair phasing: Stage 1 scenario

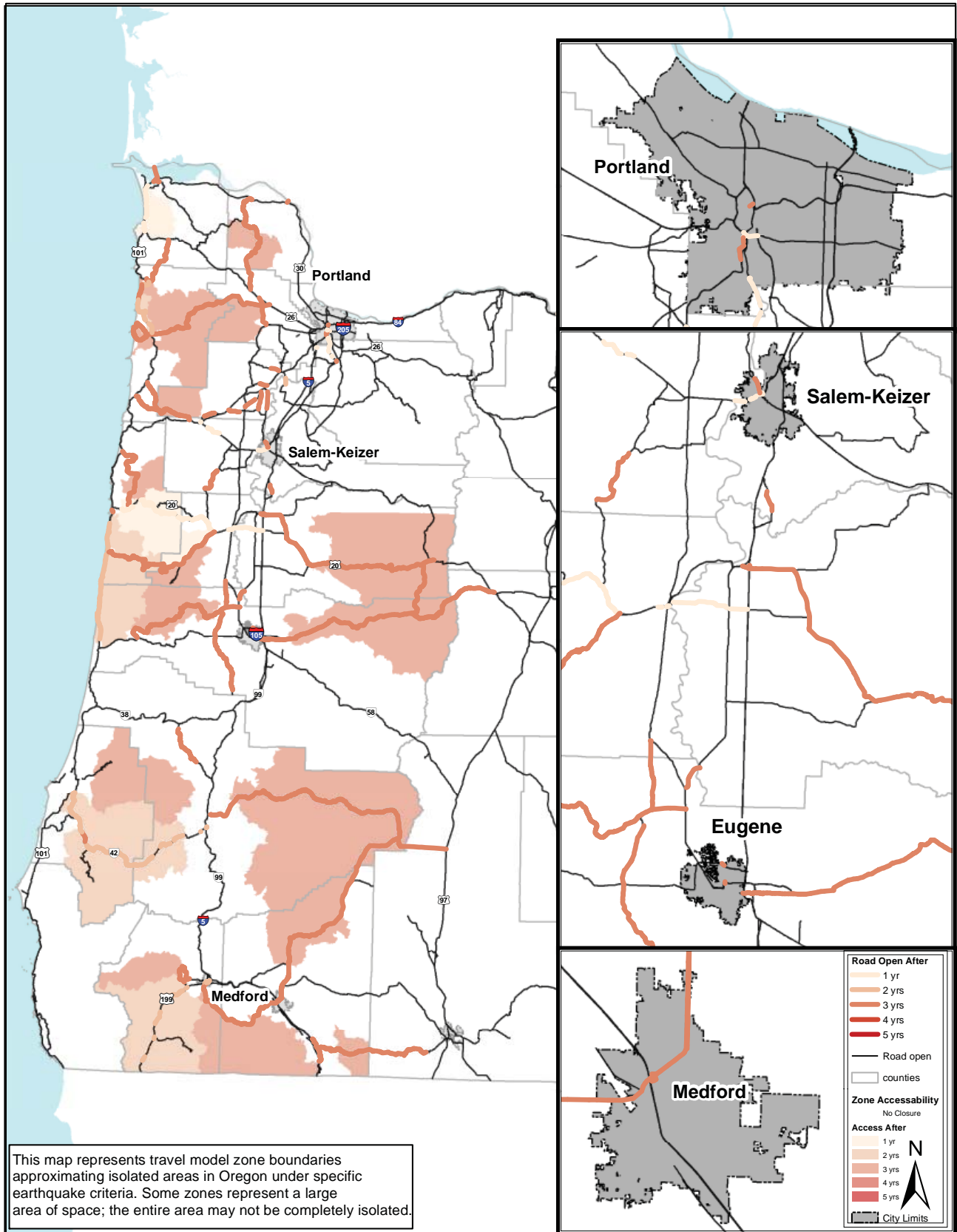

Figure G5: Isolated zones and repair phasing: Stage 1 and 2 scenario

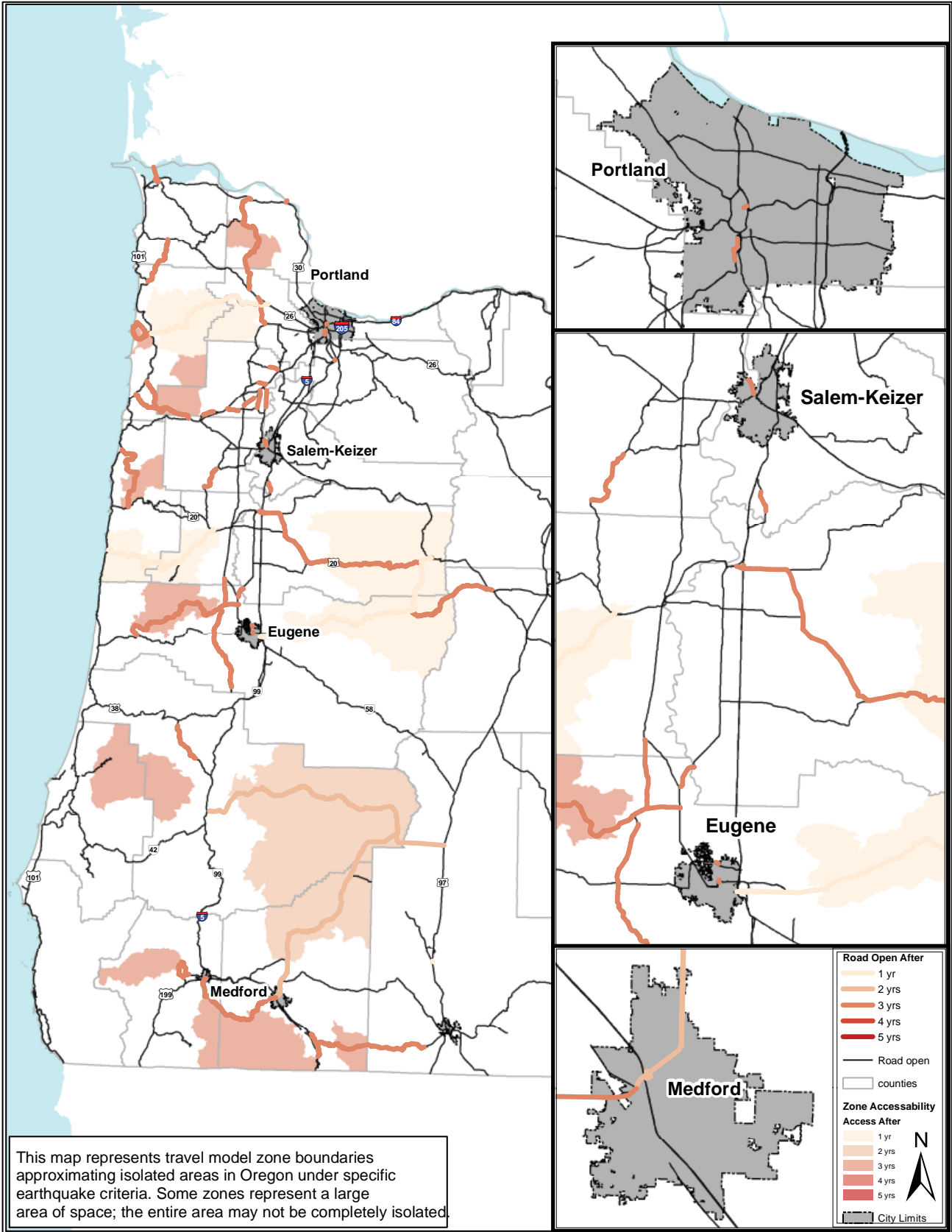

Figure G6: Isolated zones and repair phasing: Full seismic program scenario (stages 1, 2 & 3)

Findings

Western Oregon Impacts

Western Oregon would be significantly affected by a major seismic event. This region of the state generates over eighty percent of the statewide Gross State Product (GSP). In order to gain a general sense of the economic impacts avoided by strengthening of the highway system before the major event occurs, SWIM was used to produce estimates of the value of avoiding reductions to state production levels. This is an appropriate reporting approach because SWIM outputs for production activity closely relate to GSP.

The U.S. Bureau of Economic Analysis reported Oregon's 2011 Gross State Product as \$194,700 million. Table G 2 presents the western region share of GSP, including the shares for four sub-regions of the state using results from SWIM. This information is used as the basis for forecasting the state GSP for this analysis. Assuming the Oregon economy has slow growth⁵ over the next ten years (1.5 percent annually) and the western region's share of GSP remains at 86 percent, GSP is estimated for the years modeled for this analysis and presented in Table G3. The modeled year of the earthquake is 2014. These are fairly conservative economic assumptions for growth that can be altered to represent more refined economic forecast for the state if desired. However, these estimates are sufficient in order to gain a general sense of the benefits associated with the seismic program relative to no preliminary preparations.

State GSP 2011	\$194,700
Coast share (6%)	\$11,700
Greater Portland Metro (46%)	\$89,600
Mid-Willamette Valley (24%)	\$46,730
Southern Valley (10%)	\$19,500
Western Region share (86%)	\$167,400

Table G2: Regional share of Oregon gross state product; 2011 dollars, millions

⁵ Generalized growth rate based on DAS OEA forecast: http://www.oregon.gov/DAS/OEA/pages/economic.aspx#most_recent_forecast, November 20, 2012

Year after event	Estimated GSP	Western share of GSP
1	\$206,600	\$177,700
2	\$209,700	\$180,400
3	\$212,900	\$183,100
4	\$216,100	\$185,800
5	\$219,300	\$188,600
6	\$222,600	\$191,500
7	\$226,000	\$194,300

Table G3: Forecast value of production activity for western region of Oregon; estimates based on 2011 GSP with annual growth of 1.5%; western share of GSP remains 86% over time; 2011 dollars, millions

Year after event	Scenario			
	Seismic event	Stage 1	Stage 1&2	Full program
1	38%	32%	31%	27%
2	31%	28%	27%	23%
3	29%	28%	24%	21%
4	26%	26%	20%	17%
5	24%	23%	19%	17%
6	22%	18%	20%	20%
7	22%	18%	21%	21%

Table G4: Estimated % reduction in economic activity relative to reference scenario

Table G4 provides the modeled year-to-year reduction in production activity for the western region of the state for the four alternative scenarios. The value of lost production activity under each scenario is estimated using the information presented in Tables G3 and G4. The results are compared side-by-side and presented in Table G5. Over the course of the modeled years, the greatest loss to production activity occurs under the Major Seismic Event scenario. The seismic improvement program reduces these losses by billions of dollars.

Scenario				
Year after event	Seismic event	Stage 1	Stage 1&2	Full program
1	\$67,500	\$56,900	\$55,100	\$48,000
2	\$55,900	\$50,500	\$48,700	\$41,500
3	\$53,100	\$51,300	\$43,900	\$38,500
4	\$48,300	\$48,300	\$37,200	\$31,600
5	\$45,300	\$43,400	\$35,800	\$32,100
6	\$42,100	\$34,500	\$38,300	\$38,300
7	\$42,700	\$35,000	\$40,800	\$40,800
TOTAL	\$354,900	\$319,900	\$299,800	\$270,800

Table G5: Estimated reduction in economic activity relative to reference scenario; 2011 dollars, millions

Table G6 presents the dollar value of the avoided GSP reduction by scenario for the first three full years of recovery followed by the last four years. The first three years of construction for the different stage scenarios provides more than half of the economic benefit over the course of the eight-year recovery modeled. This demonstrates how important a speedy recover is to the economy of Oregon.

Scenario				
	Seismic event	Stage 1	Stage 1&2	Full program
First three years' loss	\$176,500	\$158,700	\$147,700	\$128,000
Loss avoided		\$17,800	\$28,800	\$48,500
Last four years' loss	\$178,400	\$161,200	\$152,100	\$142,800
Loss avoided		\$17,200	\$26,300	\$35,600
Total avoided loss		\$35,000	\$55,100	\$84,100

Table G6: Avoided reduction in production activity by scenario; 2011 dollars, millions

Economic Impacts by Region

For this analysis, western Oregon was divided into several sub-regions. Figure G7 illustrates the sub-regions used for this analysis:

- The Coast (split into five parts)
- The Metro Area (Portland)
- The Mid-Willamette Valley, including Salem, Corvallis and Eugene; and
- The Southern Valley area, including the area south of Eugene and north of California, bordered by the Cascade and Coastal mountain ranges.

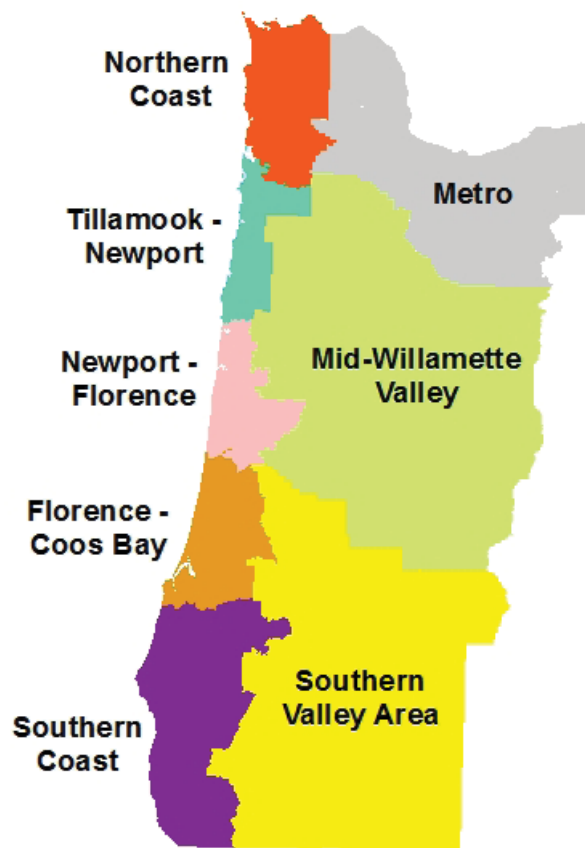

Figure G7: Areas of analysis

Table G7 provides a brief summary of the economic impacts on regional production activity for all four seismic scenarios relative to the reference scenario. The western region of Oregon generates about 86 percent of the total statewide production activity. The Coastal region represents 6 percent of statewide production activity, Portland Metro 46 percent, Mid-Willamette Valley 24 percent and the Southern Valley 10 percent. Additional details discussed in the following text are provided in Tables G8a-c.

Region (% share of state)	Seismic event			Stage 1			Stage 1&2			Full program		
	Year 1	Year 3	Year 7	Year 1	Year 3	Year 7	Year 1	Year 3	Year 7	Year 1	Year 3	Year 7
Coast total(6%)	63%	49%	11%	53%	38%	10%	49%	30%	11%	34%	24%	11%
Portland Metro (46%)	32%	25%	28%	28%	26%	21%	26%	24%	26%	25%	21%	26%
Mid-Willamette Valley (24%)	38%	26%	16%	34%	24%	15%	33%	23%	16%	25%	22%	14%
Southern Valley (10%)	49%	37%	12%	39%	33%	11%	42%	30%	11%	39%	24%	11%
Western total (86%)	38%	29%	22%	32%	28%	18%	31%	24%	21%	27%	21%	21%

Table G7: Percent reduction in economic production with respect to reference scenario

Oregon Coast

Under the Major Seismic Event scenario, the Oregon coast economy is significantly impacted, with production initially dropping over 60 percent and employment over 70 percent. Within a couple of years the economy continues to perform at a significantly lower level with 49 percent less production activity than forecast in the reference scenario and employment 63 percent lower. By the end of the seventh year after the seismic event, production activity recovers to a level 11 percent lower than the reference scenario and employment 10 percent lower.

Initial impacts along the coast vary among sub-regions, with the largest drop in production activity in the southern coast section (71 percent drop) and the smallest drop in the Newport to Florence section (55 percent drop). The effects on employment range between an 81 percent reduction in the southern coast to a 66 percent reduction in the Newport to Florence section.

The three stage scenarios reduce the impact of the seismic event. The Stage 1 initial drop in production activity is 73 percent, Stage 1&2 is 50 percent and the Full Program is 37 percent. The Stage 1 initial drop in employment is 64 percent, Stage 1&2 is 59 percent and the Full Program is 40 percent. Within a couple of years the economy continues to perform at a lower level, production activity for Stage 1 is 38 percent less, Stage 1&2 is 30 percent less and the Full Program is 24 percent less than the reference scenario. Employment for Stage 1 is 51 percent less, Stage 1&2 is 42 percent less, and the Full Program is 35 percent less. By the end of the seventh year after the seismic event, production activity recovers to a level 10 percent lower for Stage 1 and 11 percent lower for Stage 1&2 and the Full Program. Employment levels are 10 percent lower for all three scenarios.

Portland Metro

The Portland Metro economy is significantly impacted under the Major Seismic Event scenario, with production initially dropping by about 32 percent and employment about 24 percent. Within a couple of years the economy continues to perform at a significantly lower level with 25 percent less production activity than forecast in the reference scenario and employment 16 percent lower. By the end of the seventh year after the seismic event, production activity is 28 percent lower than forecast and employment 20 percent lower.

The three stage scenarios reduce the impact of the seismic event. The Stage 1 initial drop in production activity is 28 percent, Stage 1&2 is 26 percent and the Full Program is 25 percent. The Stage 1 initial drop in employment is 14 percent, Stage 1&2 is 9 percent and the Full Program is 8 percent. Within a couple of years the economy continues to perform at a lower level, production activity for Stage 1 is 26 percent less, Stage 1&2 is 24 percent less and the Full Program is 21 percent less than the reference scenario. Employment for Stage 1 is 9 percent, Stage 1&2 is 10 percent and the Full Program is 10 percent less. By the end of the seventh year after the seismic event, production activity recovers to a level 21 percent lower for Stage 1 and 26 percent lower for Stage 1&2 and the Full Program. Employment levels are 15 percent lower for Stage 1 and 19 percent lower for Stage 1&2 and the Full Program.

Mid-Willamette Valley

Under the Major Seismic Event scenario, the Mid-Willamette Valley is significantly impacted, with production initially dropping 38 percent and employment 32 percent. Within a couple of years the economy continues to perform at a significantly lower level with 26 percent less production activity than forecast in the reference scenario and employment 24 percent lower. By the beginning of the eighth year after the seismic event, production activity recovers to a level 16 percent lower than the reference scenario and employment 14 percent lower.

The three stage scenarios reduce the impact of the seismic event. The Stage 1 initial drop in production activity is 34 percent, Stage 1&2 is 33 percent and the Full Program is 25 percent. The Stage 1 initial drop in employment is 31 percent, Stage 1&2 is 30 percent and the Full Program is 26 percent. Within a couple of years the economy continues to perform at a lower level, production activity for Stage 1 is 24 percent less, Stage 1&2 is 23 percent less and the Full Program is 22 percent less than the reference scenario. Employment for Stage 1 is 23 percent, Stage 1&2 is 21 percent and the Full Program is 20 percent less. By the end of the seventh year after the seismic event, production activity recovers to a level 15 percent lower for Stage 1, 16 percent lower for Stage 1&2 and 14 percent lower for the Full Program. Employment levels are 13 percent lower for Stage 1 and the Full Program, 11 percent lower for the Stage 1&2 scenario.

Southern Valley

Under the Major Seismic Scenario, the Southern Valley is significantly impacted, with production initially dropping 49 percent and employment 56 percent. Within a couple of years the economy continues to perform at a significantly lower level with 37 percent less production activity than forecast in the reference scenario and employment 50 percent lower. By the end of the seventh year after the seismic event, production activity and employment recover to a level 12 percent lower than the reference scenario.

The three stage scenarios reduce the impact of the seismic event. The Stage 1 initial drop in production activity is 39 percent, Stage 1&2 is 42 percent and the Full Program is 39 percent. The Stage 1 initial drop in employment is 52 percent, Stage 1&2 is 54 percent and the Full Program is 48 percent. Within a couple of years the economy continues to perform at a lower level, production activity for Stage 1 is 33 percent less, Stage 1&2 is 30 percent less and the Full Program is 24 percent less than the reference scenario. Employment for Stage 1 is 45 percent, Stage 1&2 is 43 percent and the Full Program is 39 percent less. By the end of the seventh year after the seismic event, production activity recovers to a level 11 percent lower for all three stage scenarios and employment levels are 12 percent lower for Stage 1 and 10 percent lower for Stage 1&2 and the Full Program.

PRODUCTION ACTIVITY		North Coast	Coast: Tillamook-Newport	Coast: Newport-Florence	Coast: Florence-Coos Bay	South Coast	Coast Total	Greater Portland Metro	Mid-Willamette Valley	Southern Valley	Western Total
Seismic event	Year 1	58%	61%	55%	67%	71%	63%	32%	38%	49%	38%
	Year 3	31%	50%	46%	58%	64%	49%	25%	26%	37%	29%
	Year 7	9%	8%	11%	16%	7%	11%	28%	16%	12%	22%
Stage 1	Year 1	48%	49%	52%	46%	73%	53%	28%	34%	39%	32%
	Year 3	28%	44%	40%	40%	41%	38%	26%	24%	33%	28%
	Year 7	9%	6%	9%	16%	8%	10%	21%	15%	11%	18%
Stage 1&2	Year 1	43%	52%	54%	48%	50%	49%	26%	33%	42%	31%
	Year 3	21%	34%	29%	38%	29%	30%	24%	23%	30%	24%
	Year 7	9%	8%	11%	16%	8%	11%	26%	16%	11%	21%
Full program	Year 1	19%	46%	30%	43%	37%	34%	25%	25%	39%	27%
	Year 3	14%	25%	25%	33%	24%	24%	21%	22%	24%	21%
	Year 7	9%	7%	11%	16%	8%	11%	26%	14%	11%	21%

Table G8a: Estimated percent reduction in production relative to reference scenario by region, scenario and year after seismic event

EMPLOYMENT		North Coast	Coast: Tillamook-Newport	Coast: Newport-Florence	Coast: Florence-Coos Bay	South Coast	Coast Total	Greater Portland Metro	Mid-Willamette Valley	Southern Valley	Western Total
Seismic event	Year 1	67%	74%	66%	78%	81%	73%	24%	32%	56%	35%
	Year 3	35%	72%	64%	72%	81%	63%	16%	24%	50%	27%
	Year 7	8%	8%	9%	14%	9%	10%	20%	14%	12%	16%
Stage 1	Year 1	54%	65%	67%	55%	83%	64%	14%	31%	52%	29%
	Year 3	31%	65%	55%	51%	64%	51%	9%	23%	45%	23%
	Year 7	8%	7%	9%	14%	9%	10%	15%	13%	12%	14%
Stage 1&2	Year 1	47%	68%	69%	56%	61%	59%	9%	30%	54%	28%
	Year 3	23%	53%	37%	49%	52%	42%	10%	21%	43%	21%
	Year 7	8%	7%	8%	12%	9%	10%	19%	11%	10%	15%
Full program	Year 1	11%	66%	32%	52%	51%	40%	8%	26%	48%	23%
	Year 3	12%	50%	26%	47%	49%	35%	10%	20%	39%	19%
	Year 7	9%	7%	9%	10%	9%	10%	19%	13%	10%	15%

Table G8b: Estimated percent reduction in employment relative to reference scenario by region, scenario and year after seismic event

POPULATION		North Coast	Coast: Tillamook-Newport	Coast: Newport-Florence	Coast: Florence-Coos Bay	South Coast	Coast Total	Greater Portland Metro	Mid-Willamette Valley	Southern Valley	Western Total
Seismic event	Year 1	65%	76%	59%	73%	80%	70%	15%	28%	53%	29%
	Year 3	35%	74%	56%	67%	80%	61%	11%	20%	48%	23%
	Year 7	7%	6%	9%	14%	9%	9%	19%	12%	11%	15%
Stage 1	Year 1	55%	69%	60%	49%	81%	63%	10%	27%	49%	26%
	Year 3	30%	68%	48%	43%	62%	49%	10%	19%	44%	21%
	Year 7	3%	5%	9%	32%	10%	9%	11%	10%	11%	10%
Stage 1&2	Year 1	44%	72%	62%	52%	59%	57%	6%	25%	50%	25%
	Year 3	22%	56%	27%	42%	50%	39%	10%	17%	42%	19%
	Year 7	1%	5%	8%	35%	6%	8%	18%	5%	8%	14%
Full program	Year 1	13%	71%	23%	49%	47%	39%	6%	23%	45%	21%
	Year 3	12%	55%	19%	41%	45%	34%	9%	17%	39%	17%
	Year 7	7%	6%	10%	35%	8%	9%	17%	11%	7%	13%

Table G8c: Estimated percent reduction in population relative to reference scenario by region, scenario and year after seismic event

ANALYSIS TEAM

Transportation Planning Analysis Unit

Alex Bettinardi, PE, Senior Integrated Analysis Engineer

Becky Knudson, Senior Transportation Economist

Brian Dunn, PE, Manager

Beth Pickman, Transportation Analyst

Matthew Palm, Intern

Bridge Section

Albert Nako, PE, Seismic Standards Engineer

Bruce Johnson, PE, State Bridge Engineer

Curran Mohney, Senior Engineering Geologist

Consultant Team

Erin Wardell, Parsons Brinkerhoff

Joel Freedman, Parsons Brinkerhoff

Ben Stabler, Parsons Brinkerhoff

Chris Frazier, Parsons Brinkerhoff

Daniel Flight, Parsons Brinkerhoff

Rick Donnelly, PhD, Parsons Brinkerhoff

John Abraham, PE, PhD, HBA Specto

Doug Hunt, PE, PhD, HBA Specto

Graham Hill, HBA Specto

Geraldine Fuenmayor, HBA Specto

Carl Batten, ECONorthwest

APPENDIX H

SEISMIC PLUS ECONOMIC ANALYSIS: MAJOR EARTHQUAKE DOES NOT OCCUR

Background

In 2012 ODOT estimated the economic benefits of a pre-emptive seismic program scenario simulating economic impacts in the event a major subduction zone earthquake (9.0) occurred. The final results, published in January of 2013¹, found that by preventively and proactively retrofitting the sections of state highway infrastructure identified to be vulnerable in a major earthquake event (718 bridges and 1185 landslide and rockfall locations), the state of Oregon could avoid losing \$84 billion (in 2011 dollars) in gross domestic product following a catastrophic earthquake. At the time of the original analysis (2012), the seismic program was budgeted at approximately \$1.8 billion to complete. The original budget assumed only seismic retrofit work would be completed at each location identified. However, as the seismic program concept was further refined, ODOT identified that many of the bridges that needed retrofits were also pre-identified for scheduled maintenance and repair during the time span of the programmed seismic work. ODOT determined it would be wasteful and inefficient to only seismically retrofit bridges also requiring essential maintenance at that future date, so the seismic program was re-developed as the “Seismic Plus” program. The Seismic Plus plan is currently estimated to cost \$5.1 billion. The expanded budget adds significant life to all 718 identified bridges, beyond just the seismic enhancements.

Even at a cost of \$5.1 billion, the Seismic Plus program still delivers benefits that far surpass costs in the event of major earthquake. However, since the Seismic Plus program improves many of the bridges well beyond their current projected service life, regardless of whether an earthquake occurs or not, ODOT determined that it was important to assess the economic benefits of the Seismic Plus program under the scenario that no large earthquake occurs in the foreseeable future.

Methodology

ODOT’s Transportation Planning Analysis Unit (TPAU) was able to deliver this analysis quickly by pivoting off of the work recently completed for the “Rough Roads Ahead” Report. As part of that analysis it was determined 898 bridges would require varying degrees of maintenance between 2015 and 2035 in order to operate as they do today. In most of the 898 cases it was determined that if the bridge was not maintained, then weight restrictions would occur, greatly impacting Oregon’s economy. The analysis found:

- Under current projected funding levels for state maintained highways, Oregon’s cumulative gross domestic product would be an estimated \$94 billion less (2014 dollars) between 2015 and 2035, as weight restrictions slowly became required on the majority of the identified bridges over the next 30 years

¹ http://www.oregon.gov/ODOT/TD/TP/docs/Statewide_CascadiaSubductionZoneEarthquake_EconomicImpact_2012.pdf

- An estimated loss of 103,000 jobs in Oregon by 2035
- Another \$240 billion (2014 dollars) of lost gross domestic product between 2035 and 2050 as the roads continued to degrade, with the potential loss of an additional 30,000 jobs as pavement conditions worsened.

Because the Seismic Plus project list had a high degree of overlap with the 2015-2035 bridge need list, an addendum Seismic Plus scenario was run to determine what the benefit of repairing the Seismic Plus bridges would be for the state under the scenario that no earthquake occurs -in other words, evaluating the economic benefit just from reducing the number of weight restricted bridges on Oregon highways.

To complete the seismic analysis, first the Seismic Plus project list and 2015-2035 bridge need list were compared. As shown in Figure H1 below, the five seismic phases closely align with specific corridors. The corridors are set in priority based on the Oregon Resilience Plan² work.

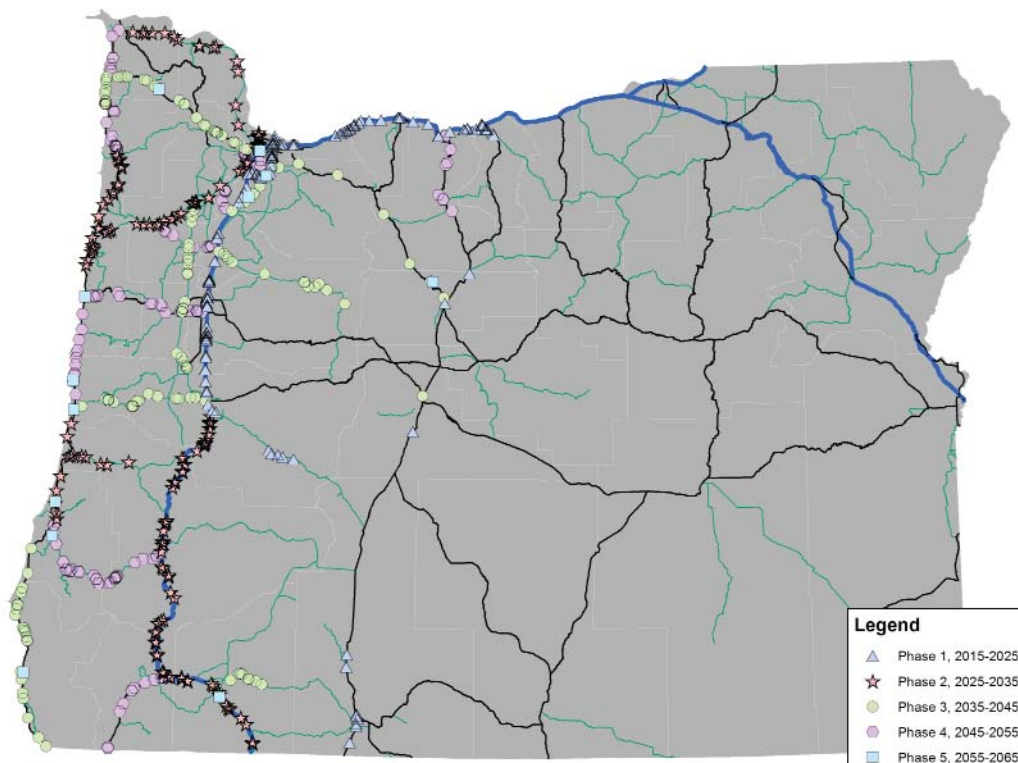

Figure H1: The 718 Bridges comprising the Seismic Plus Program by Phase

The maintenance needs of Oregon’s bridges do not conform to corridors by priority. Maintenance needs arise from the age and use patterns of a given bridge. Therefore, the Seismic Plus schedule based on corridor priority and bridge maintenance needs driven by daily wear and tear do not perfectly align.

² http://www.oregon.gov/OMD/OEM/ossprac/docs/Oregon_Resilience_Plan_draft_Executive_Summary.pdf

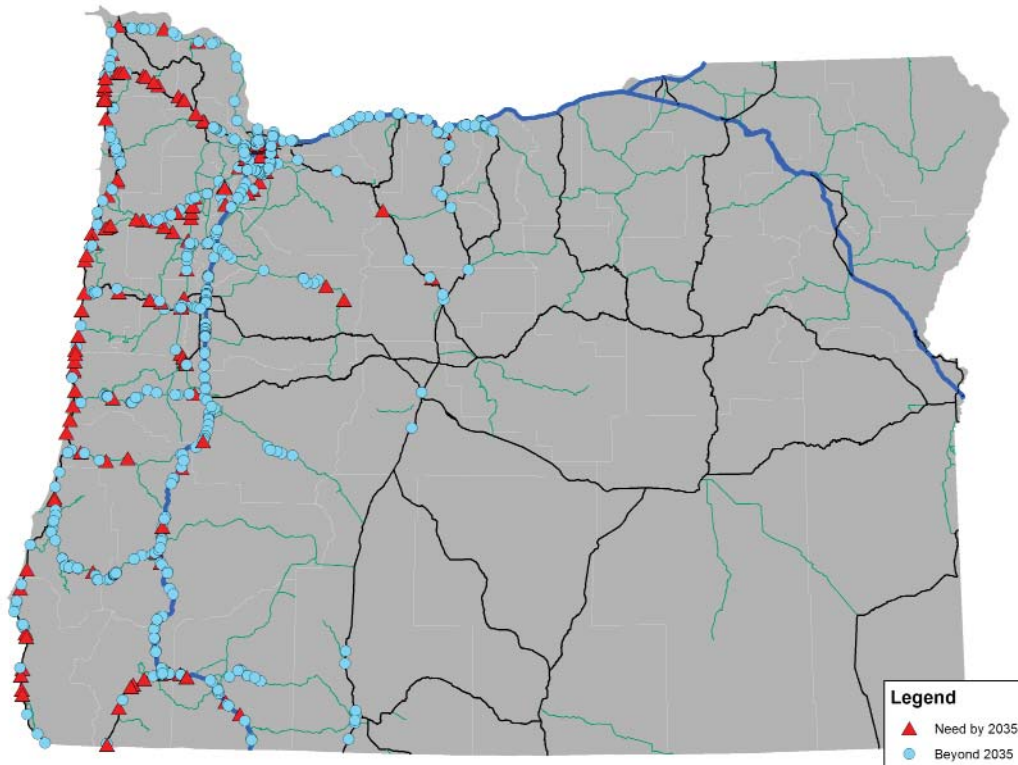

Figure H2: Project Overlap between the State Bridges Needing Repair in the Next 20 Years and the Seismic Plus project list for Bridges

Figure H2 above shows geographically where the 150 bridges requiring maintenance by 2035 are within the 718 bridges of the Seismic Plus program.

ODOT reviewed the scheduling and timing inconsistencies and found over the first 20 years, the projects identified as having a pressing maintenance need also on the seismic list totaled approximately \$2 billion. This is roughly the amount currently estimated for the first two phases (20 years) of the Seismic Plus program. Yet there is uncertainty when forecasting bridge needs out 20 years. Some of the bridges could last an additional 10 years before requiring maintenance; some of the bridges might need maintenance 10 years sooner.

All bridges in Oregon are inspected on regularly. The conditions of each bridge are monitored closely and maintenance projections and budgets are revised accordingly. Because of this, projects might shift in priority and in schedule based on needs. To minimize the frequency of maintenance efforts on the state highways, ODOT would work to minimize costs and user impacts by shifting projects around. This led to a seismic scenario assumption that if a bridge was on the 2015-2035 need list and the Seismic Plus project list, it would be addressed prior to weight restrictions being required. Hence those bridges would operate into the future as they do today, and the repair costs would be covered under the currently developed Seismic Plus project list. An important detail to capture is that while the 2015-2035 project list identifies bridges needing maintenance by 2035,

the analysis has assumed weight restrictions would not be required at the exact time of the maintenance date. It is assumed up to 10 years could pass beyond the maintenance date prior to significant weight restrictions³ being posted. The 150 bridges identified in Figure H2 are estimated to require significant weight restrictions by 2035 or sooner. They represent about \$2 billion of projects in the Seismic Plus program. Looking over the entire 20-year need list, there are 329 bridges in the Seismic Plus project list. The additional 179 bridges (150 + 179 = 329 bridges) are estimated to require repair between 2035 and 2050. All 329 bridges represent about \$3.4 billion of projects in the Seismic Plus program. This means that over 35 years (2015 - 2050) the needs list closely corresponds to the Seismic Plus annual budget, as did the first 20 years. Therefore, the assumption that Seismic Plus projects and funds could be revised to address maintenance needs is still valid.

The 2015-2035 bridge need list used in the "Rough Roads Ahead" Report is estimated to cost between \$4 and \$5 billion (in 2014 dollars). The budget did not include any seismic retrofitting work, just an estimated budget to keep the bridges functioning as they do today. Because of this, while the 329 bridges that overlapped between the two project lists are estimated to cost \$3.4 billion in the Seismic Plus budget, they were only estimated to cost roughly \$2 billion to return to today's function. The difference is the cost of the seismic retrofits of the 329 bridges required.

Seismic Plus Scenario Description

Consequently, the additional scenario analyzed for the Seismic Plus assumed 329 of the 898 bridges identified in the need list were already addressed by the Seismic Plus work. Additionally, \$50 million per year (\$1 billion over 20 years) was assumed to be available to address the highest priority bridges. This is the current assumed bridge budget over the next 20 years under current funding projections. The billion-dollar budget was assumed to be prioritized on the OTIA Routes, stages 1-5 (see Figure H3.) Additionally, the remaining assumed budget was able to address bridge needs that are not on the OTIA routes, such as US 101, OR 22, OR 20, and 99E & 99W.

This resulted in 280 additional bridges assumed to be properly maintained, making for a total of 609 (329 + 280) bridges assumed to be addressed under the seismic list scenario and 289 (898 - 609) bridges that were assumed to become weight restricted between 2015 and 2050. Figure H4 illustrates which bridges were assumed to be repaired under Seismic Plus; which bridges were assumed repaired under current funding assumptions; and which bridges were not addressed, eventually becoming weight restricted.

³ The analysis assumed that weight restrictions would be increased over time, such as first limiting overweight vehicles and uncommon configurations, and then eventually increasing to limit common shippers. In this context "significant weight restrictions" is envisioned to be a limit to 64,000 lbs, significantly impacting the haulers and shipments in Oregon. It was assumed that significant weight restriction would not occur immediately in the year that bridge maintenance was required; significant weight restriction would not occur until 5-10 years beyond the bridge maintenance date.

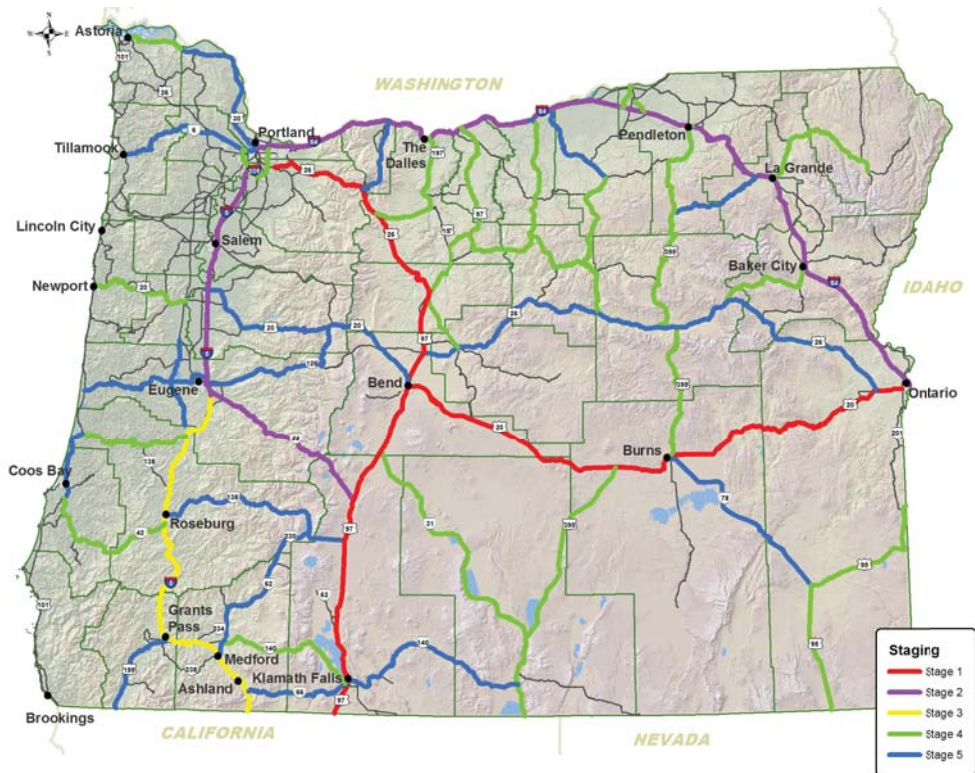

Figure H3: OTIA Routes by Stage

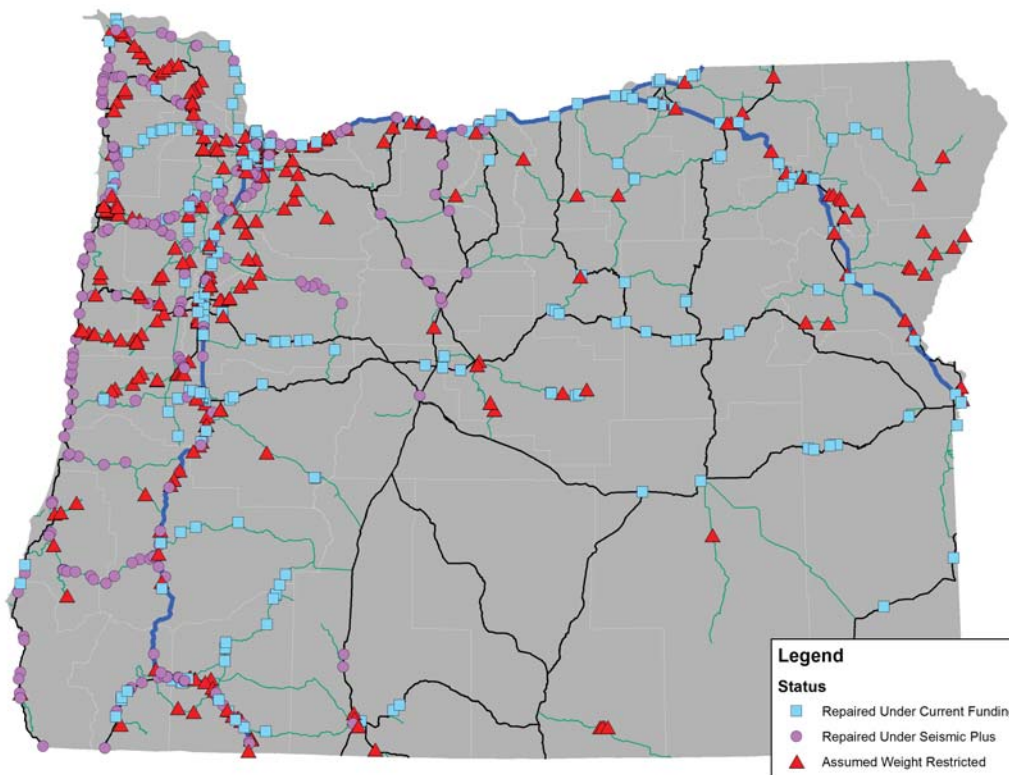

Figure H4: Bridge Maintenance Assumptions in the Seismic Plus Scenario

Findings

The analysis of this seismic list scenario found that 70 percent of the state product and employment lost under current funding projections could be saved if the projects on the Seismic Plus list that had been identified as a need between 2015 and 2035 were completed prior to weight restriction. The product and employment benefit of these projects is in comparison to the current funding scenario that was completed in the “Current and Future Pavement and Bridge Investment Impacts to the Oregon Economy” Report. In that report it was estimated by year 2035 about 103,000 Oregon jobs would be lost and the state Gross Domestic Product (GDP) would have been reduced by \$94 billion (2014 dollars) between 2015 and 2035. In comparison to this scenario, **by completing the Seismic Plus projects identified between 2015 and 2035, the state is estimated to gain 70,000 jobs by 2035 and grow Oregon’s State Product by \$66 billion (2014 dollars) between 2015 and 2035.** Between 2035 and 2050, the current funding scenario is projected to reduce cumulative GDP by another \$240 billion (2014 dollars). This equates to roughly \$170 billion plus \$65 billion for a total of \$235 billion estimated to be saved or gained above the current funding scenario projections by 2050 if the Seismic Plus projects identified between 2015 and 2035 are completed (see Table H1).

Year	Current Funding Compared to No Deterioration	Seismic Plus Compared to Current Funding
2015-2035	-\$94 billion	+\$65 billion
2035-2050	-\$240 billion	+\$170 billion
Total (2015-2050)	-\$334 billion	+\$235 billion

Table H1: GDP Comparisons between Scenarios

Important Caveats and Assumptions

It is important to note while the benefits are projected out to 2050, ODOT’s bridge specific need list is only estimated out 20 years. ODOT had already established that the bridge need will be greater in decades of 2040 and 2050. This is due to the aging interstate era bridges that will need significant repair during these decades. Because the bridge specific need list currently stops at 2035, ODOT does not have the ability to make assumptions about which bridges would become weight restricted in 2040 and beyond. ODOT is aware, however, that the current funding gap is significant, and current funding projections show that not all bridges will be able to be maintained and some will require weight restrictions. Similarly, because ODOT does not know which bridges might require weight restriction beyond the 2035 need list, the benefits of the Seismic Plus program cannot be fully assessed because it is not clear how many of the projects in Seismic Plus might be degraded to weight restriction if the maintenance under the Seismic Plus program did not occur.

This is an important caveat, because while the losses or gains are projected out to the year 2050, they don't actually represent the full losses or benefits one could expect or calculate when going out to 2050. The project need list stops in 2035. The analysis has been conducted on the impacts of that 20-year need list. After 2035 some of the bridges with an identified "need" don't become significantly weight restricted until after 2035 (2045 in some cases). So to fully assess the impacts of the 20-year need list the analysis needs to go out until 2050. However, by 2050, bridges with an un-met need between 2035 and 2050 would also start to impact the economic conditions of the state. So the important detail to be aware of is that the analysis goes to 2050, but the need list only goes to 2035. **Therefore it is proper to assume that the estimates that go to 2050 in this addendum and the full "Rough Roads Ahead" report are conservative estimates, and assuming that funding levels remain similar to current projections, the impacts of the current funding projection scenario would be worse than projected by 2050 and the relative gains and improvements due to the Seismic Plus project list would be larger and better for the state than currently estimated.**

Similarly, the Seismic Plus project schedule is currently estimated to run 50 years to 2065. So to fully calculate the economic benefits of the Seismic Plus program under the scenario that a major earthquake does not occur, ODOT would first need to generate a 50-year need list with specific bridges identified and then compare that 2015–2065 list against the projects in the proposed Seismic Plus program. With this list, the economic benefits of the full program could be assessed. As is stated above, it is proper to assume that the full benefits of the Seismic Plus program would be larger than the \$236 billion (2014 dollars) currently estimated to be gained by the state of Oregon between 2015 and 2050 due to the Seismic Plus program.

As a final caveat, the numbers above are the benefit if the major subduction zone earthquake does not occur by 2050. It is a matter of when, not if, a major earthquake will occur off the coast of Oregon. Currently geologists predict that Oregon is overdue for the next major earthquake. If Oregon is fortunate enough to not witness a major earthquake prior to the completion of the proposed Seismic Plus program, Oregon would first realize the economic benefits identified in this addendum. Then, if Oregon was able to complete the Seismic Plus program prior to the next major earthquake, all the economic gains of the improved bridges would be obtained. When the earthquake did eventually occur, Oregon would get the effective "lump-sum payment" of the \$84 billion (2011 dollars) estimated to be the value of the seismic project list in the event of the earthquake. So with the Seismic Plus program, Oregon would get the pre- and post-earthquake economic benefits. If the earthquake did occur prior to the completion of the proposed Seismic Plus program, the analysis conducted in 2012 by ODOT forecasts the state of Oregon would still get a pro-rated benefit for a partial completion, but that the highest benefit-to-cost ratio comes with completing the entire program.

It is clear that the Seismic Plus program returns a high benefit-to-cost ratio (well above 1), regardless if it is fully completed, and regardless if the next major earthquake occurs in the foreseeable future.

OREGON HIGHWAYS SEISMIC **PLUS** REPORT

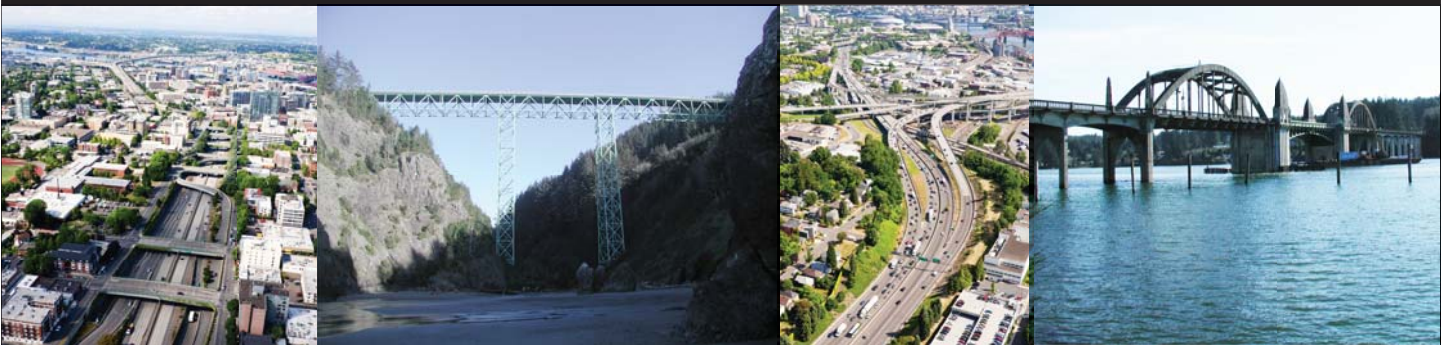

OREGON HIGHWAYS SEISMIC **PLUS** REPORT



Bridge and Geo-Environmental Sections
Technical Services Branch
Oregon Department of Transportation

October 2014
Publication Design by Chittirat Amawattana