



OREGON
DEPARTMENT OF
ENERGY

Community Renewable Energy Grant Program

May 25, 2022

OUR TIME TOGETHER TODAY

- Program Review
- Project Example
- Application Process
- Q&A

Please use chat to ask questions
along the way.



Raise hands or chat during the
Q&A.



USING WEBEX

Audio Options

Mute *Microphone On*

Unmute *Microphone Off*

Speaker

- Use system setting (ThinkPad USB-...)
- Headset Earphone (ThinkPad USB-...)
- Speakers (Realtek(R) Audio)
- E1342CKR (Intel(R) Display Audio)

Microphone

- Use system setting (ThinkPad USB-...)
- Microphone Array (Realtek(R) Audio)
- Headset Microphone (ThinkPad US-...)

Webex smart audio

Noise removal

Audio settings...

You're using computer for audio

Switch audio

You can check Speaker and Microphone settings by clicking the arrow next to Mute/Unmute.

Second Raise Hand Option

You can also click on the hand next to your name in the Participant list to raise your hand.

Click on Lower hand when you are done.

Attendees (1)

DA DEMO Att... Me

Chat

You can chat to Everyone in the meeting.

Chat

from shiela.alicar@energy.oregon.gov to everyone: 12:59 PM

Hello to Everyone!

To: Everyone

Enter chat message here

You can send a private message to the Host or Presenter (or all Panelists when there is a Panel).

Chat

from shiela.alicar@energy.oregon.gov to everyone: 1:00 PM

Hello to Everyone!

to Shiela (privately): 1:00 PM

Hello to Shiela!

To: alicar

From: Everyone

Shiela (Host)

Shiela (Presenter)

Reactions

Raise hand

Send reaction

Unmute

Click to Raise your hand.

Lower hand

Click on Lower hand when you are done.

Participants

Chat

DA DEMO Att... Me

COMMUNITY RENEWABLE ENERGY GRANT PROGRAM

HB 2021 Established the Community Renewable Investment Fund to:

- Offset costs of planning and developing community renewable energy projects
- Support projects in traditionally underserved communities
- Promote small-scale community renewable energy projects
- Provide direct benefits to communities across Oregon by improving energy resilience, creating local jobs, promoting economic development, and offsetting local energy costs.



ELIGIBLE APPLICANTS

Tribes

Counties and Cities

Municipalities

Special government bodies such as
ports and irrigation districts

Consumer-Owned Utilities

Cannot Fund Projects in Portland

BUDGET PRIORITIES

- 50 percent or more for grants to be awarded for planning or developing community renewable energy projects that qualify as **community energy resilience projects**.
- 50 percent or more for grants to be awarded for planning or developing community renewable energy projects that primarily serve **one or more qualifying communities**.

QUALIFYING COMMUNITIES

Environmental Justice Communities:

- Communities of color
- Communities experiencing lower incomes
- Tribal communities
- Rural communities
- Coastal communities
- Communities with limited infrastructure
- Communities traditionally underrepresented in public processes and adversely harmed by environmental and health hazards, including seniors, youth and persons with disabilities

ADVISORY COMMITTEE

Committee Member	Organization	Title
Quinn Read	Center for Biological Diversity	Oregon Policy Director
Mark Brady	Business Oregon	Innovation Strategist
Audrey Burkhardt	PGE	Energy Storage and Resiliency Product Manager
Gail Malcolm	Central Lincoln PUD	Senior Project Manager
Shannon Souza	SolCoast, OCEAN, POET, and OSSIA	Principal CEO, Executive Director, and Policy Lead
Danny Martinez	Confederated Tribes of Warm Springs	Tribal Emergency Manager
Commissioner Phil Chang	Deschutes County	County Commissioner
Les Perkins	Farmers Irrigation District	General/District Manager
Alan Johnston	City of Gresham	Senior Engineer
Oriana Magnera	Verde	Energy, Climate, and Transportation Program Manager
Alessandra de la Torre	Rogue Climate	Energy Justice Organizer
Nick Johnson	Lake County Resources Initiative	Executive Director
Stan Thomas	Oregon Office of Emergency Management	Deputy Director
Michael Harryman	Office of Governor Kate Brown	State Resilience Officer
Brandi Martin	Office of Cybersecurity, Energy Security, & Emergency Response (CESER)	Program Manager

TIMELINE

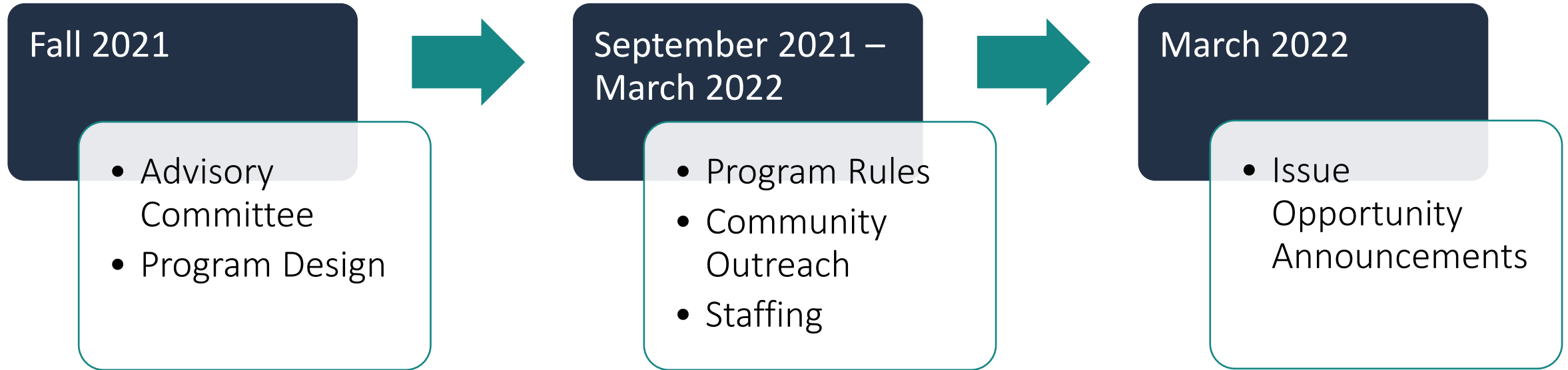

EUGENE WATER AND ELECTRIC BOARD

Resilience Project

Focus:

1. Emergency Preparedness and Disaster Recovery
2. Electric Supply Resources

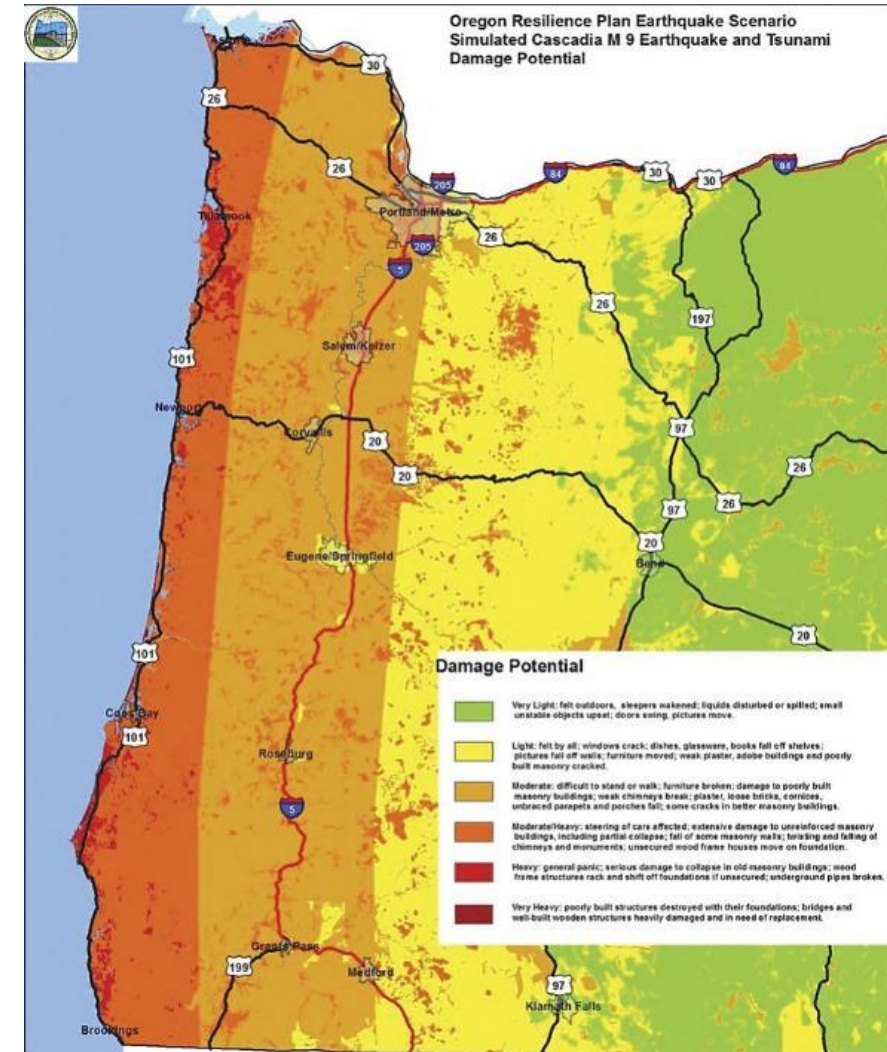
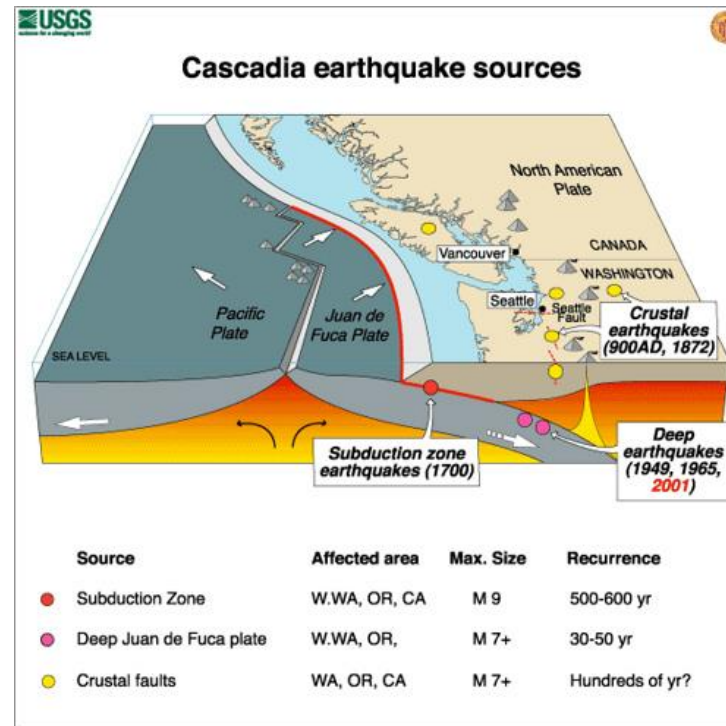

EUGENE WATER AND ELECTRIC BOARD

Rule of 3s

Restoration Order

3 days

Emergency Water Distribution Sites

3 weeks

Power Critical Facilities

3 months

System Repair and Restoration



Grid Edge Demonstration Project in Eugene
Photos courtesy of Eugene Water and Electric Board

 Emergency preparedness is a shared responsibility

How much water do you need?



 **1 gallon PER DAY**

for each: 

for **3** days

 Minimum household emergency water storage recommended by the American Red Cross

PREPARE. REPLACE. MAINTAIN. Reliance

EUGENE WATER AND ELECTRIC BOARD

Grid Edge Demonstration Project

Howard Elementary School, Eugene

- Existing 50kW rooftop PV system
- 2 X 510kWh battery storage units
- New potable water well

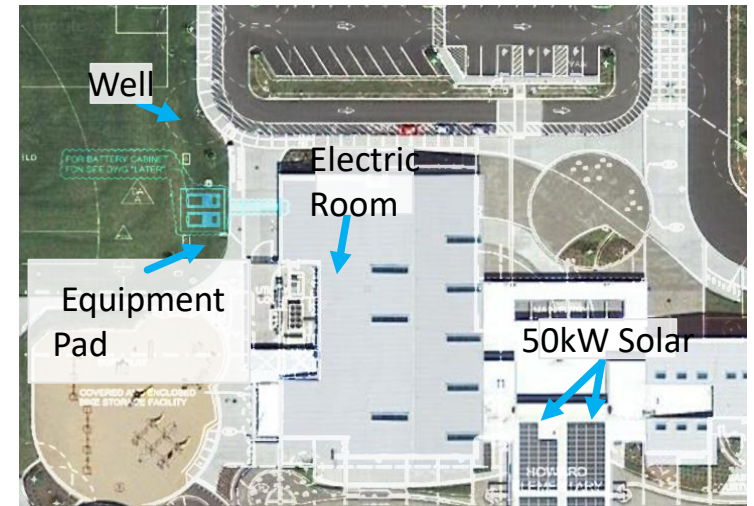

Grid Edge Demonstration Project in Eugene
Photos courtesy of Eugene Water and Electric Board

EUGENE WATER AND ELECTRIC BOARD

Grid Edge Demonstration Project

Howard Elementary School, Eugene

- Community potable water fill station
- School to serve as emergency shelter and operations center.
- Reduced electricity costs for school
- Pilot grid services from batteries.



Grid Edge Demonstration Project in Eugene
Photos courtesy of Eugene Water and Electric Board

Howard Elementary Microgrid

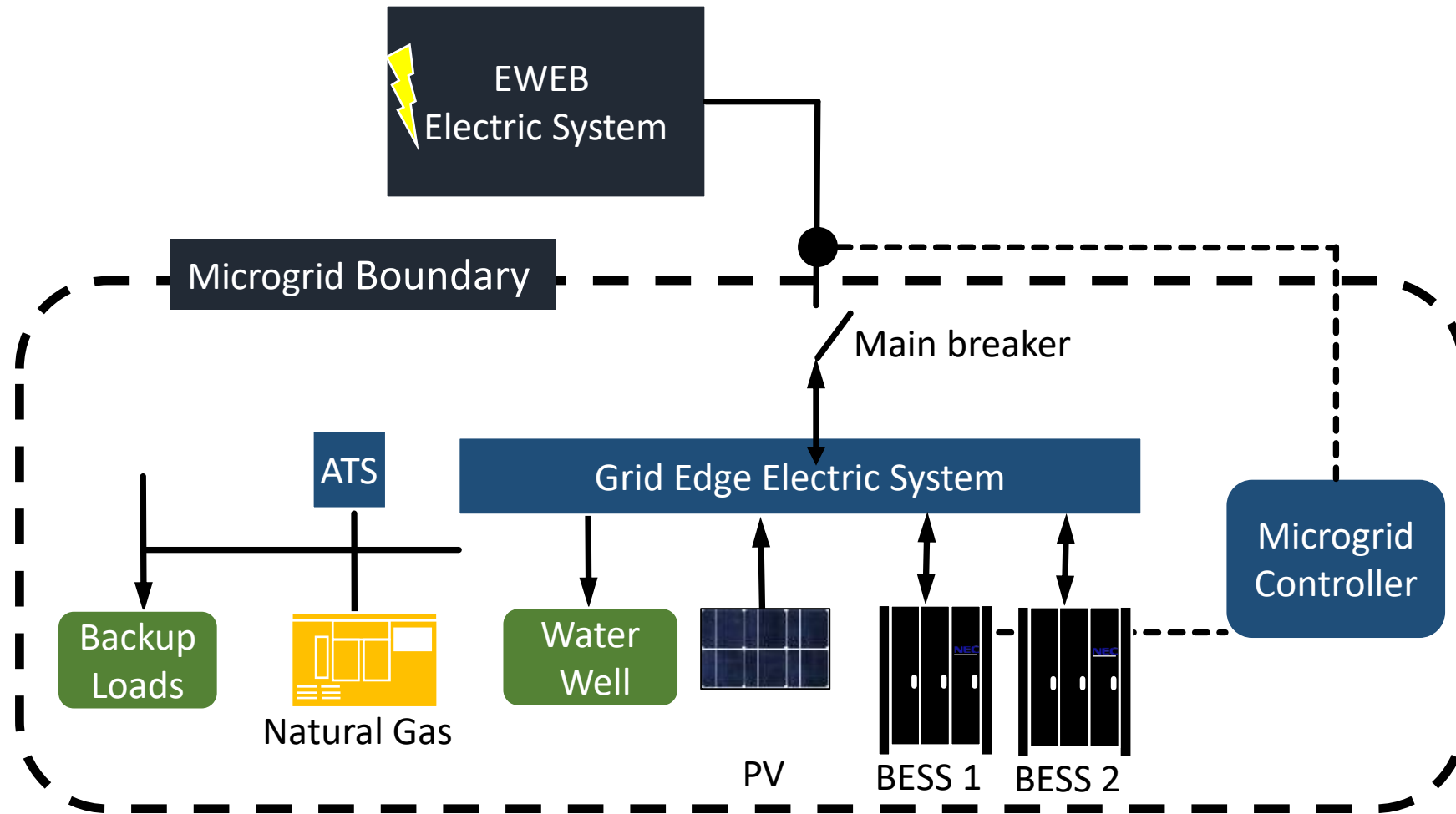

PROGRAM OPPORTUNITY ANNOUNCEMENTS

PROJECT CATEGORY	MAXIMUM GRANT AWARD	MAXIMUM % OF COST
Planning, Energy Resilience	\$100,000	100%
Planning, Renewable Energy Only	\$100,000	100%
Construction, Energy Resilience	\$1,000,000	100%
Construction, Renewable Energy Only	\$1,000,000	50%

\$50M total funding. Grants will be awarded on a competitive basis and will include performance agreements and time limits for completing projects.

APPLICATION REVIEW

- Completion and eligibility review
- Competitive review
 - Strength of proposed project and its feasibility
 - Community benefits
 - Equity considerations
 - Diversity of project



APPLICATIONS

<https://www.oregon.gov/energy/Incentives/Pages/CREP.aspx> 

Community Renewable Energy Grant Program

OREGON SOLAR + STORAGE
REBATE PROGRAM

ENERGY EFFICIENT WILDFIRE
REBUILDING INCENTIVE

HEAT PUMP INCENTIVE PROGRAMS

► **COMMUNITY RENEWABLE ENERGY
GRANT PROGRAM**

RURAL & AGRICULTURAL ENERGY
AUDIT PROGRAM

ENERGY INCENTIVES & GRANT
PROGRAMS

 *HB 2021 created a \$50 million fund at ODOE to provide grants for planning and developing community renewable energy and energy resilience projects.*



The Community Renewable Energy Grant Program is open to Oregon Tribes, public bodies, and consumer-owned utilities. Public bodies include counties, municipalities, and special government bodies such as ports and irrigation districts. Grants are awarded on a competitive basis and priority will be given to projects that support program equity goals, demonstrate community energy resilience, and include energy efficiency and demand response.



At least half of the grant funds will be awarded for projects that serve environmental justice communities, including communities of color, lower-income communities, rural communities, and others. Similarly, at least half of the grant funds will be awarded to projects that support community energy resilience.

Grant Amounts

RESOURCES

-  [HB 2021](#)
-  [CREP Advisory Committee](#)
-  [Rulemaking](#)
-  [Administrative Rules](#)

-  [Program Flyer – Construction Projects](#)
-  [Program Flyer – Planning Projects](#)

OPPORTUNITY ANNOUNCEMENTS

March 2022

 [Apply Online Now](#) 

\$12 Million Available | Applications Due July 8, 2022

- **22-001:** Planning activities for a renewable and resilient project
- **22-002:** Planning activities for a renewable project
- **22-003:** Construction of a renewable and resilient project
- **22-004:** Construction of a renewable

APPLICATIONS

<https://odoe.powerappsportals.us/en-US/> 



Home | Submit a Comment | Financial/Incentive | Received Comments/Data | Ask Energy | Other | Sign in

Community Renewable Energy Grant Program
Rural and Agricultural Energy Audit Program

LET'S CONNECT!

OREGON
DEPARTMENT OF
ENERGY

OVERVIEW OF GRANT PROCESS

Construction Grants

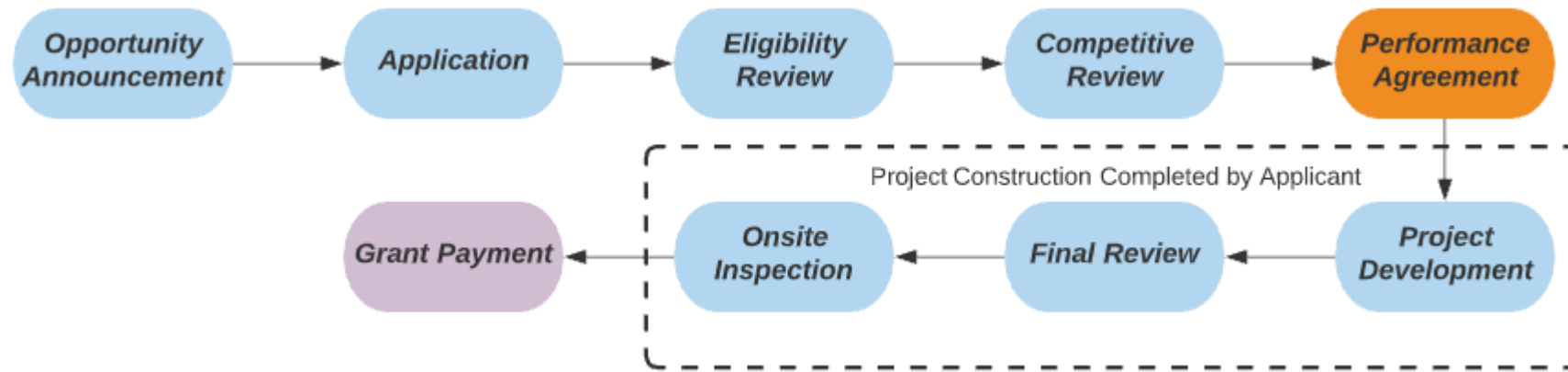

Planning Grants

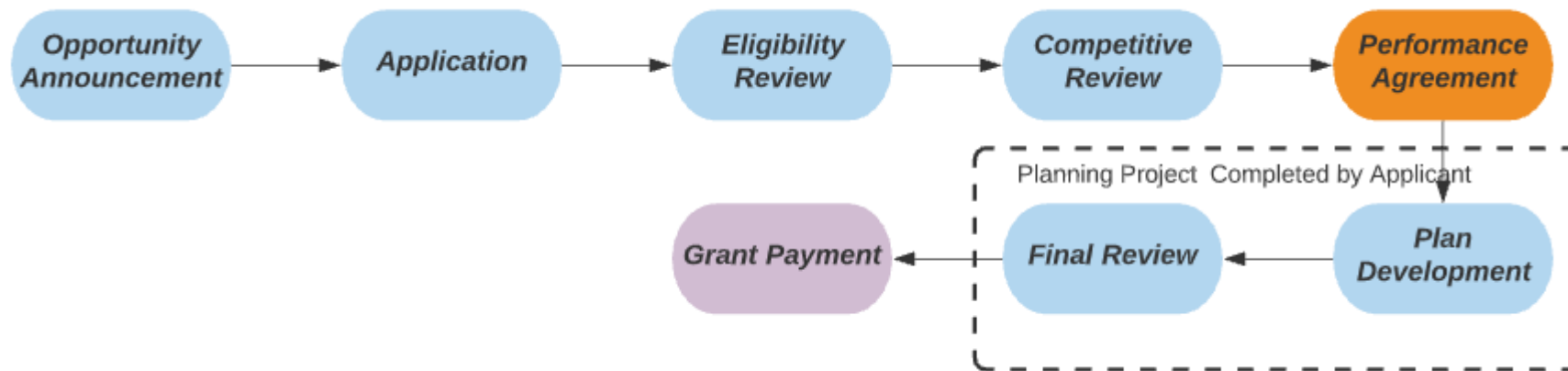

THANK YOU

www.oregon.gov/energy/Incentives/Pages/CREP.aspx

Contact:

community.grants@energy.oregon.gov

503-378-4040

